



INSTRUCTION MANUAL

ACENDO VIBE™

ACV-2100 ACENDO VIBE™ CONFERENCING SOUNDBAR

ACV-5100 ACENDO VIBE™ CONFERENCING SOUNDBAR WITH CAMERA



IMPORTANT SAFETY INSTRUCTIONS

1. READ these instructions.
2. KEEP these instructions.
3. HEED all warnings.
4. FOLLOW all instructions.
5. DO NOT use this apparatus near water.
6. CLEAN ONLY with dry cloth.
7. DO NOT block any ventilation openings. Install in accordance with the manufacturer's instructions.
8. DO NOT install near any heat sources such as radiators, heat registers, stoves, or other apparatus (including amplifiers) that produce heat.
9. DO NOT defeat the safety purpose of the polarized or grounding type plug. A polarized plug has two blades with one wider than the other. A grounding type plug has two blades and a third grounding prong. The wider blade or the third prong are provided for your safety. If the provided plug does not fit into your outlet, consult an electrician for replacement of the obsolete outlet.
10. PROTECT the power cord from being walked on or pinched, particularly at plugs, convenience receptacles, and the point where they exit from the apparatus.
11. ONLY USE attachments/accessories specified by the manufacturer.
12. USE ONLY with a cart, stand, tripod, bracket, or table specified by the manufacturer; or sold with the apparatus. When a cart is used, use caution when moving the cart/apparatus combination to avoid injury from tip-over:



13. UNPLUG this apparatus during lightning storms or when unused for long periods of time.
14. REFER all servicing to qualified service personnel. Servicing is required when the apparatus has been damaged in any way, such as power-supply cord or plug is damaged, liquid has been spilled or objects have fallen into the apparatus, the apparatus has been exposed to rain or moisture, does not operate normally, or has been dropped.
15. DO NOT expose this apparatus to dripping or splashing and ensure that no objects filled with liquids, such as vases, are placed on the apparatus.
16. To completely disconnect this apparatus from the AC Mains, disconnect the power supply cord plug from the AC receptacle.
17. Where the mains plug or an appliance coupler is used as the disconnect device, the disconnect device shall remain readily operable.
18. DO NOT overload wall outlets or extension cords beyond their rated capacity as this can cause electric shock or fire.



The exclamation point, within an equilateral triangle, is intended to alert the user to the presence of important operating and maintenance (servicing) instructions in the literature accompanying the product.



The lightning flash with arrowhead symbol within an equilateral triangle is intended to alert the user to the presence of uninsulated "dangerous voltage" within the product's enclosure that may be of sufficient magnitude to constitute a risk of electrical shock to persons.



ESD Warning: The icon to the left indicates text regarding potential danger associated with the discharge of static electricity from an outside source (such as human hands) into an integrated circuit, often resulting in damage to the circuit.

- WARNING: To reduce the risk of fire or electrical shock, do not expose this apparatus to rain or moisture.
- WARNING: No naked flame sources - such as lighted candles - should be placed on the product.
- WARNING: Equipment shall be connected to a MAINS socket outlet with a protective earthing connection.
- WARNING: To reduce the risk of electric shock, grounding of the center pin of this plug must be maintained.

COPYRIGHT NOTICE

AMX© 2018, all rights reserved. No part of this publication may be reproduced, stored in a retrieval system, or transmitted, in any form or by any means, electronic, mechanical, photocopying, recording, or otherwise, without the prior written permission of AMX. Copyright protection claimed extends to AMX hardware and software and includes all forms and matters copyrightable material and information now allowed by statutory or judicial law or herein after granted, including without limitation, material generated from the software programs which are displayed on the screen such as icons, screen display looks, etc. Reproduction or disassembly of embodied computer programs or algorithms is expressly prohibited.

LIABILITY NOTICE

No patent liability is assumed with respect to the use of information contained herein. While every precaution has been taken in the preparation of this publication, AMX assumes no responsibility for error or omissions. No liability is assumed for damages resulting from the use of the information contained herein. Further, this publication and features described herein are subject to change without notice.

AMX WARRANTY AND RETURN POLICY

The AMX Warranty and Return Policy and related documents can be viewed/downloaded at www.amx.com.

Table of Contents

Acendo Vibe Conferencing Soundbars	5
Overview	5
ACV-5100 - Product Specifications	5
Camera (ACV-5100 only).....	5
ACV-2100 - Product Specifications	6
Side Panel Keypad	6
Volume and Mute Controls	6
Bluetooth Pairing Button	6
Remote Control	7
Installing Batteries.....	7
Acendo Vibe Configuration Tool	7
Installing Acendo Vibe	8
Overview	8
Credenza Installation	8
Wall Mount Installation	8
Removing the Wall Mount Bracket	8
Wall Mount Considerations.....	8
Using the Bracket Mounting Guide	9
Mounting the Wall Mount Bracket and Attaching the Acendo Vibe	10
Connections	11
ACV-5100 Connectors	11
ACV-2100 Connectors	12
Rotating the Acendo Vibe Into the Seated Position	12
Installing Lock-Down Screws	13
Side Panel Keypad	13
Volume and Mute Controls	13
Camera (ACV-5100 only)	13
Remote Control	14
Pairing the Remote Control to the Acendo Vibe	14
Pairing the Acendo Vibe with a Bluetooth Source Device	14
Setting the Acendo Vibe as the Default Audio Device	14
Connecting RS232 for Serial Commands	14
Connecting an External Motion Sensor (b future firmware update / ACV-5100 only)	15
Acendo Vibe Configuration Tool	15
Setup Mode.....	15
Configuring Acendo Vibe Conferencing Sound Bars	16
Overview	16
Downloading and Installing the Acendo Vibe Configuration Tool	17

Connecting to the the Acendo Vibe via USB	20
Accessing the USB Connector	20
Entering Setup Mode.....	21
Exiting Setup Mode	21
USB Connected Window	21
Transfer Options Window.....	22
Bluetooth Configuration Options.....	22
Events Configuration Options (ACV-5100 only)	23
Audio Configuration Options	24
File Options (Open, Save and Transfer).....	25
Opening an Existing Acendo Vibe Configuration File	25
Saving Settings as an Acendo Vibe Configuration File	26
Transfer settings from this file	27
Viewing/Modifying an Acendo Vibe Configuration File.....	27
Sending New Settings to Acendo Vibe.....	28
Getting Current Settings From Acendo Vibe	29
Sending Firmware Update to Acendo Vibe.....	29
Serial Commands	31
Overview	31
RS-232 Connector Specifications.....	31
Command Protocol	31
Protocol Definition.....	31
Syntax.....	31
Case Sensitivity	31
Path Syntax.....	31
Command / Reply	31
Parameters	31
Unsupported command reply	31
Getting and setting values	32
Paths	32
Execute command	32
Get value.....	32
Set value.....	32
Errors	33
Error reply	33
Unrecognized command reply	33
Events.....	33
Serial Commands.....	33
Serial Commands - ACV-2100 & ACV-5100	33
Serial Commands - ACV-5100 ONLY	35
Events	38
Troubleshooting	39

Acendo Vibe Conferencing Soundbars

Overview

The ACV-2100 and ACV-5100 Acendo Vibe™ Conferencing Sound Bars are expertly designed web conferencing sound bars featuring USB and *Bluetooth*® connectivity support for BYOD environments. Dedicated analog audio inputs and outputs allow the Acendo Vibe to easily integrate with other room technology.

The ACV-5100 Acendo Vibe Conferencing Sound Bar with Camera also features an integrated wide-angle camera and HDMI inputs and outputs with CEC display control.

Both Acendo Vibes feature a connector bay door that also serves as a hinged Wall Mount Bracket, which allows easy access to the connector bay without having to dismount the unit. The Wall Mount Bracket features a cutout for cable routing and straps for cable management.

ACV-5100 - Product Specifications

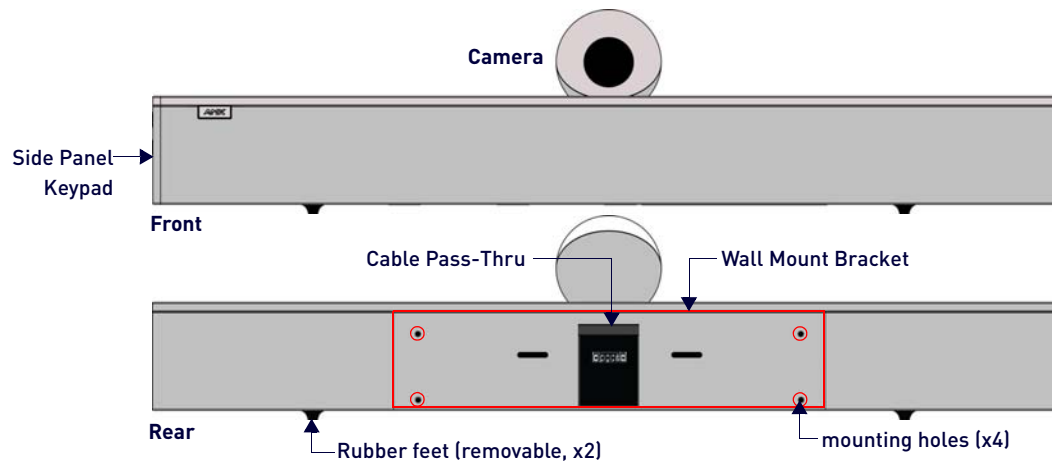

FIG. 1 ACV-5100 (Front/Rear views)

ACV-5100 Product specifications	
MODELS AVAILABLE	<ul style="list-style-type: none"> ACV-5100GR, Grey (FG4151-00GR) ACV-5100BL, Black (FG4151-00BL)
INCLUDED ACCESSORIES	<ul style="list-style-type: none"> 15V / 4A Power Supply Remote Control 6' USB 2.0 Cable 5mm Wall Mount Spacers (4) Lock-Down Screws (2)
DIMENSIONS (HWD)	<ul style="list-style-type: none"> 5" x 23 1/2" x 3 15/16" (76 mm x 590 mm x 100 mm) Depth with optional wall mount spacers: 4 1/8" (105 mm)
WEIGHT	6.45 lbs (2.93 kg)
ACTIVE POWER REQUIREMENTS	<ul style="list-style-type: none"> ~100-240V, 1.3A max Only use the included power supply
REGULATORY COMPLIANCE	FCC 47 CFR Part 15, Subpart C / Subpart B (emissions) EN 55024, EN 60950-1, IEC/EN/UL 60065:2014
ENVIRONMENTAL	<ul style="list-style-type: none"> Temperature (Operating): 32° F to 113° F (0° C to 45° C) Temperature (Storage): -4° F to 158° F (-20° C to 70° C) Humidity (Operating): 5% to 85% RH non-condensing
OPTIONAL ACCESSORIES	<ul style="list-style-type: none"> CBL-USB-FL2-16, USB 2.0 16ft Extension Cable (FG10-2220-16) CBL-USB-FL2-33, USB 2.0 33ft Extension Cable (FG10-2220-33) ACR-5100, Meeting Collaboration System (FG4051-00)

Camera (ACV-5100 only)

The ACV-5100 is equipped with a wide-angle camera for videoconferencing and supports a wide range of web conferencing applications via its USB port. Refer to the *Camera (ACV-5100 only)* section on page 13 for details.

NOTE: To adjust the camera's view, simply grasp the camera and rotate to the desired position.

ACV-2100 - Product Specifications

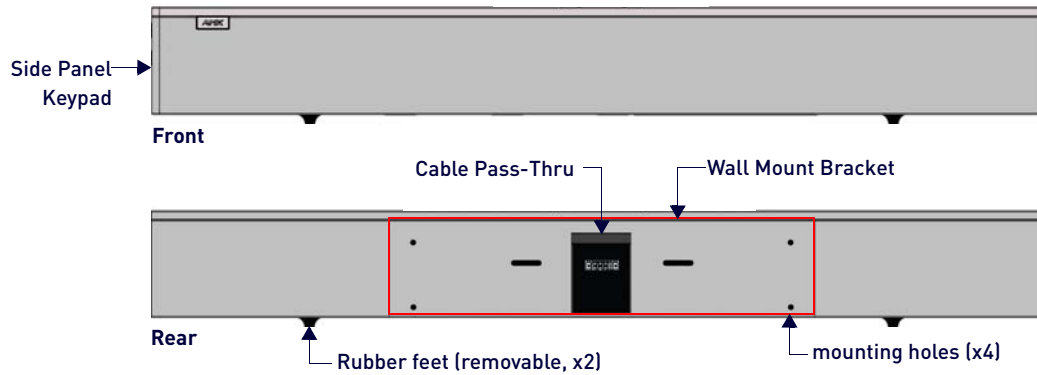

FIG. 2 ACV-2100 (Front/Rear views)

ACV-2100 Product specifications	
MODELS AVAILABLE	<ul style="list-style-type: none"> ACV-2100GR, Grey (FG4121-00GR) ACV-2100BL, Black (FG4121-00BL)
INCLUDED ACCESSORIES	<ul style="list-style-type: none"> 15V / 4A Power Supply Remote Control 6' USB 2.0 Cable 5mm Wall Mount Spacers (4) Lock-Down Screws (2)
DIMENSIONS (HWD)	<ul style="list-style-type: none"> 3" x 23 1/2" x 3 15/16" (76 mm x 590 mm x 100 mm) Depth with optional wall mount spacers: 4 1/8" (105 mm)
WEIGHT	6.3 lbs (2.86 kg)
ACTIVE POWER REQUIREMENTS	<ul style="list-style-type: none"> ~100-240V, 1.3A max Only use the included power supply
REGULATORY COMPLIANCE	FCC 47 CFR Part 15, Subpart C / Subpart B (emissions) EN 55024, EN 60950-1, IEC/EN/UL 60065:2014
ENVIRONMENTAL	<ul style="list-style-type: none"> Temperature (Operating): 32° F to 113° F (0° C to 45° C) Temperature (Storage): -4° F to 158° F (-20° C to 70° C) Humidity (Operating): 5% to 85% RH non-condensing
OPTIONAL ACCESSORIES	<ul style="list-style-type: none"> CBL-USB-FL2-16, USB 2.0 16ft Extension Cable (FG10-2220-16) CBL-USB-FL2-33, USB 2.0 33ft Extension Cable (FG10-2220-33) ACR-5100, Meeting Collaboration System (FG4051-00)

Side Panel Keypad

All controls and LEDs are on the left side panel of the Acendo Vibe (FIG. 3):

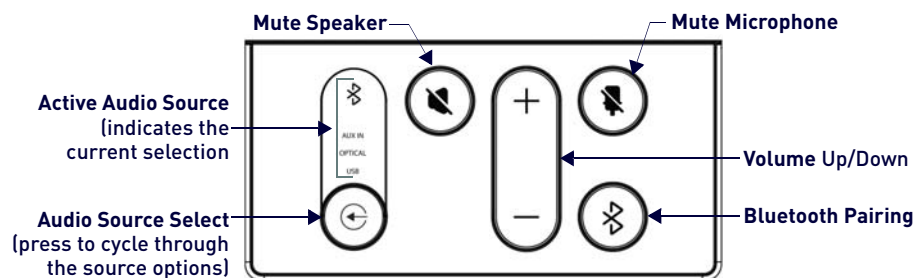

FIG. 3 Acendo Vibe LEFT SIDE PANEL Keypad

Volume and Mute Controls

- Use the **Volume Up/Down** buttons to adjust speaker volume.
- Mute Speaker** and **Mute Microphone** enable/disable the speakers and microphone. Note that these buttons illuminate to indicate when the sound functions are muted.

Bluetooth Pairing Button

Use this button for pairing the Acendo Vibe with a Bluetooth source device. For instructions, refer to the *Pairing the Acendo Vibe with a Bluetooth Source Device* section on page 14.

Remote Control

The Acendo Vibe includes a color matched remote control that connects wirelessly (FIG. 4):

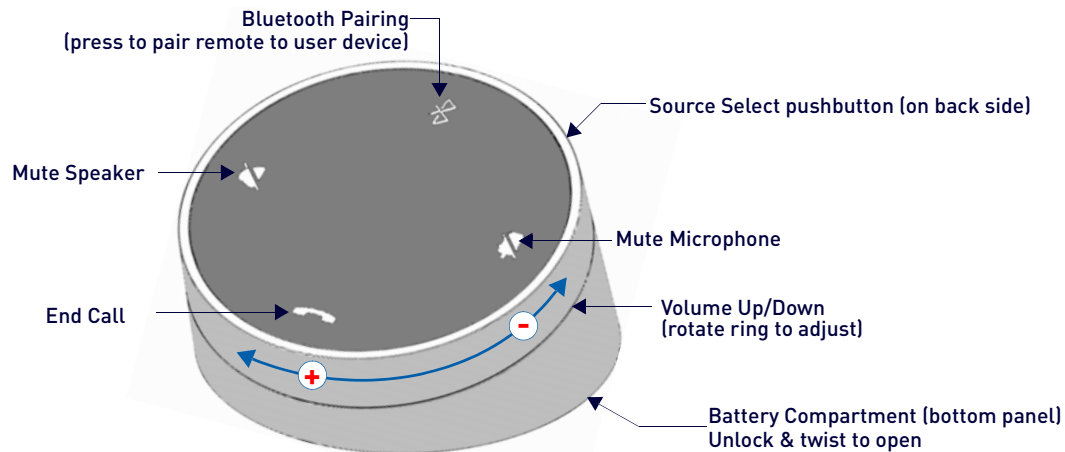

FIG. 4 Acendo Vibe Remote Control

Installing Batteries

1. Remove the bottom panel of the remote control to access the battery compartment:
2. On the bottom panel, flip the plastic lock to the Unlocked position (FIG. 5):

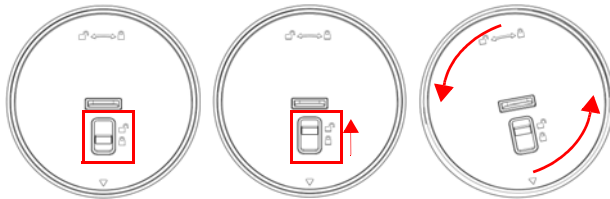

FIG. 5 Remote control - bottom panel (lock/unlock/remove)

3. Rotate the bottom panel to the left and lift to remove.
4. Insert two AA batteries.
5. Replace and lock the bottom panel.

For details and instructions on pairing the remote control to the Acendo Vibe see page 14.

Acendo Vibe Configuration Tool

Both Acendo Vibe Sound Bars are configured via the Acendo Vibe Configuration Tool software (available to download from AMX). In most cases the default settings should work fine without any need for adjustment. Configurable settings include:

- **Bluetooth (On/Off)** - Click to toggle On/Off (default = On).
- **Bluetooth Device Name** - Enter a new name for the Acendo Vibe unit. This is the device name for the Acendo Vibe when discovered via Bluetooth (default = "Acendo Vibe").
- **Events** (ACV-5100 only) - Configure how CEC display control operates relative to defined events, and adjust Occupancy Sensor settings (see page 15).
- **Aux Out Gain** - Select Variable (default) or Fixed.
- **Default Volume** - Enter a value for the default output volume (default = 50, valid for all audio sources).
- **Automatic Audio Switching** - Toggle On/Off (default = On).
- Use the **File** (**Open**, **Save** and **Transfer**) options to save the current settings, open an existing config file, and transfer the current settings to an Acendo Vibe via USB connection.

For details, see the *Configuring Acendo Vibe Conferencing Sound Bars* section on page 16.

Installing Acendo Vibe

Overview

This section describes the physical installation of the Acendo Vibe unit. Note that many of the mounting illustrations use the ACV-5100 as an example, but these mounting instructions apply equally to the ACV-2100.

NOTE: Do not lift the ACV-5100 by the camera or rest the ACV-5100 unit on the camera.

Credenza Installation

NOTE: To ensure highest possible sound quality, the rubber feet on the bottom panel must remain in place for surface-mount installations.

The Acendo Vibe can sit on a hard, flat surface such as a credenza, tabletop or desk. When choosing a surface location, consider a space that will not interfere with workspaces or other installed devices. Connect cables as necessary - see the *Connections* section on page 11 for details.

Wall Mount Installation

For best aesthetic in wall mount installations, remove the rubber feet from the bottom panel: carefully peel each foot off of the bottom surface.

Removing the Wall Mount Bracket

1. Open the Wall Mount Bracket (held closed by internal magnets).
2. Press and hold the **Release Button** to slide the Bracket out (over the button) to disengage the pins on the Bracket from the hinges on the unit (FIG. 6).

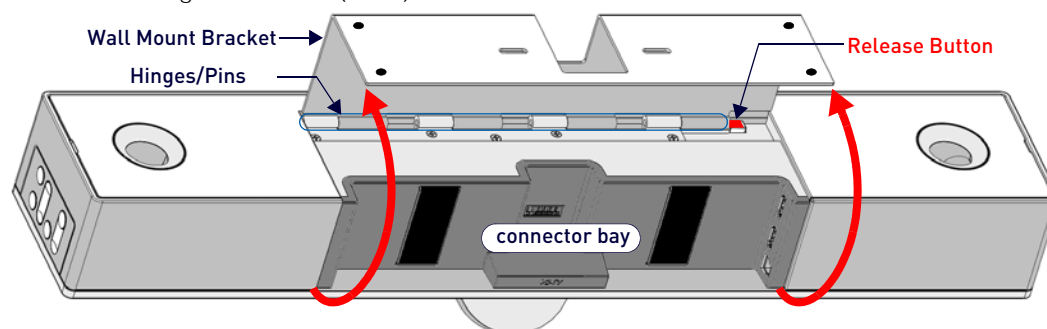

FIG. 6 Acendo Vibe Bottom View - opening the wall mount bracket

3. Lift the Wall Mount Bracket off of the hinges to remove (FIG. 7):

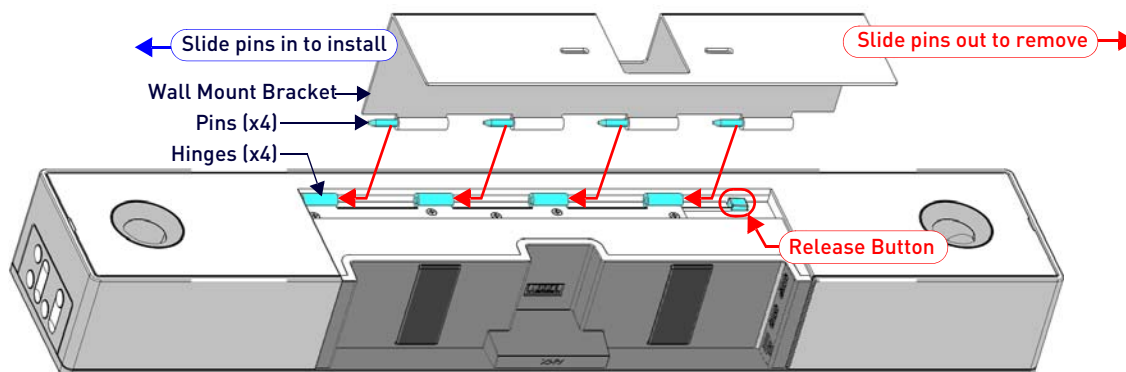

FIG. 7 Acendo Vibe Bottom View - removing the bracket

Wall Mount Considerations

- **Distance between conference table and display:** The closer the table is to the wall-mounted display, the lower the display should be mounted. As a general guide, the display should be mounted between 40" and 48" from the floor (see FIG. 8 on page 9).
- **Avoid obstructing the camera view:** If the display protrudes from the wall more than the Acendo Vibe, then additional spacing between the display and the Acendo Vibe may be needed.
- **Position camera for full visibility:** In small rooms, it may be necessary to manually tilt the camera up to maximize visibility for all participants.

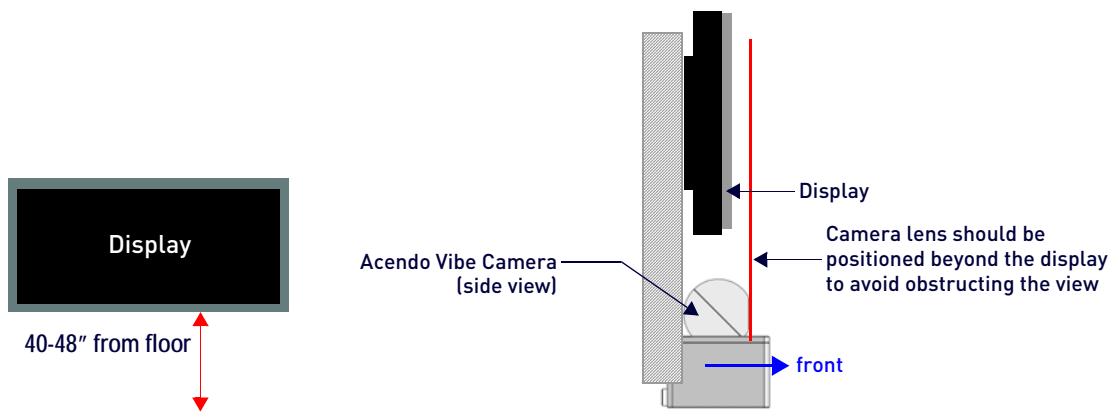

FIG. 8 Acendo Vibe Wall Mount Considerations

Using the Bracket Mounting Guide

The Wall Mount Bracket features instructions etched on the inner surface that describe how to position the Acendo Vibe beneath a wall-mounted display to avoid obstructing the camera view (FIG. 9):

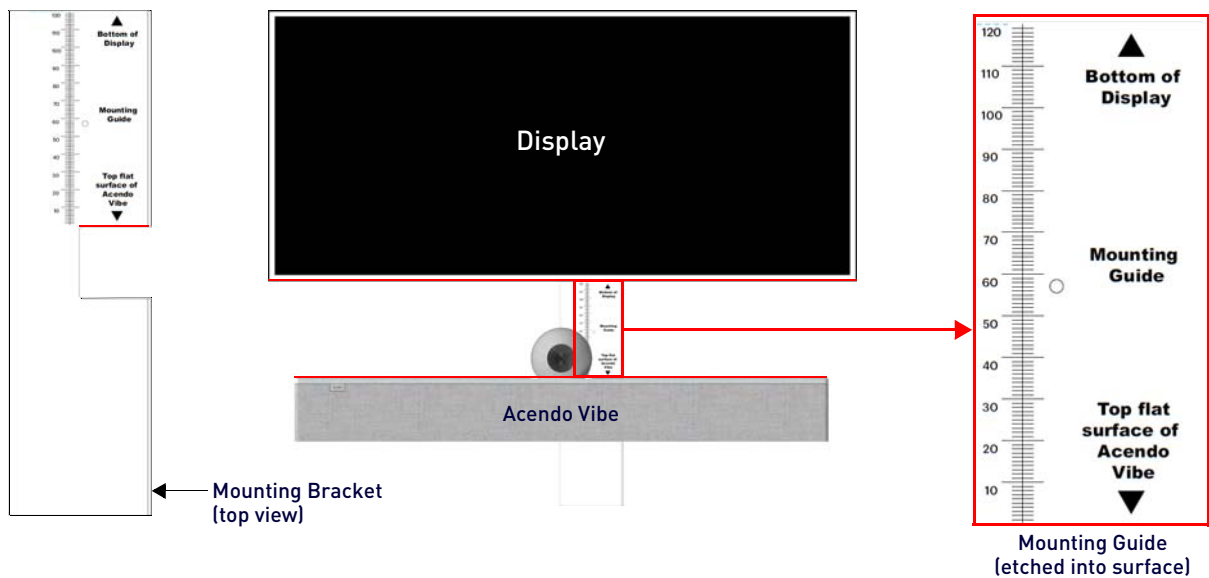

FIG. 9 Using The Mounting Guide

1. Remove the Bracket from the Acendo Vibe (see FIG. 7 on page 8).
2. Turn the Bracket vertically and place against the wall, centered directly beneath the wall-mounted display.
3. Align the top of the Bracket (see **Bottom of Display**) with the bottom surface of the display.
4. Use the top edge of the notch in the Bracket (see **Top flat surface of Acendo Vibe**) to determine the closest placement for the Acendo Vibe beneath the display. Mark the mounting surface.
5. Align the top flat surface of the Acendo Vibe with the mark made in step 4.
6. Mount the Bracket using mounting screws and optional mounting spacers (see FIG. 10).

Mounting the Wall Mount Bracket and Attaching the Acendo Vibe

1. Use the Wall Mount Bracket as a template to mark the locations for the four mounting screws (not included). Use mounting screws and hardware appropriate for the surface being utilized to secure the Bracket to the wall.
Optionally, if not hiding them behind the drywall, place the four included Wall Mount Spacers between the Bracket and the wall to create a 5mm gap for routing flat cables (FIG. 10).

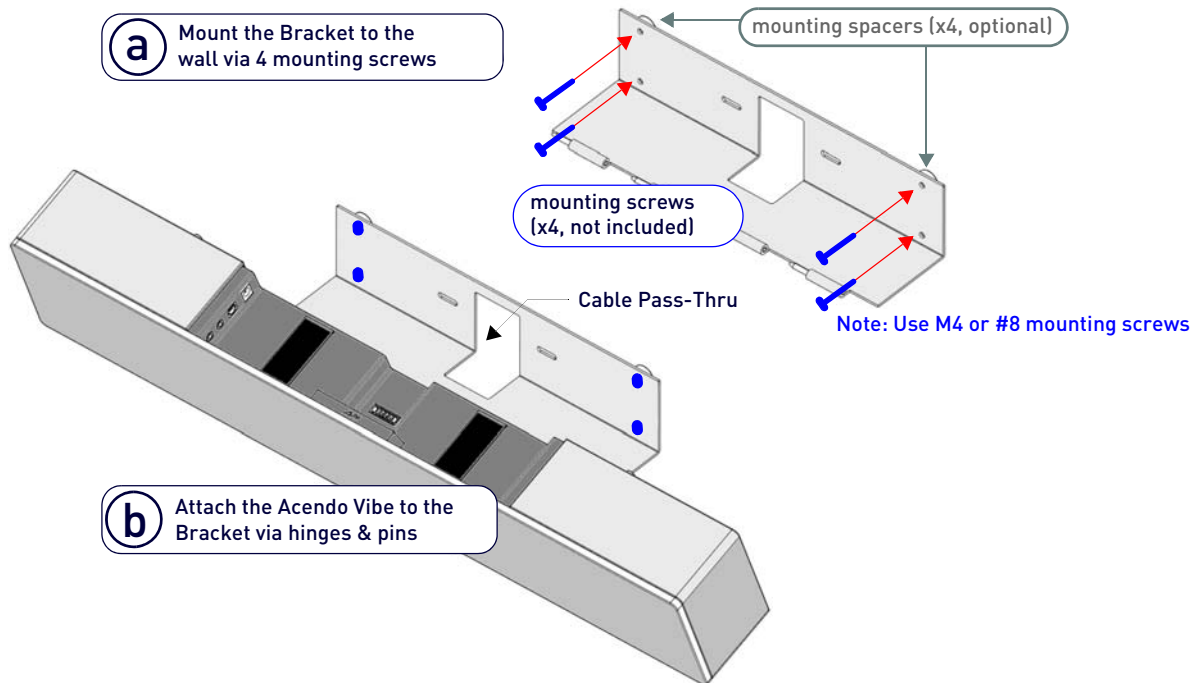

FIG. 10 Wall Mounting the Acendo Vibe

2. Attach the Acendo Vibe to the Bracket by sliding the pins on the Bracket into the hinges on the rear of the main unit (see FIG. 7):
 - a. Position the Acendo Vibe with the bottom panel facing the wall and align the hinges on the main unit with the pins on the Bracket.
 - b. Carefully slide the pins into the hinges, until the Bracket snaps into place.
Note: Press the Bracket into place so that the last pin depresses the Release Button, allowing the pins to slide into the hinges (see FIG. 7)
 - c. With the Acendo Vibe attached to the Bracket, rotate the unit up to its seated position. Note that the Bracket snaps shut and is held closed via internal magnets.
Note: Ensure that cables do not obstruct the complete closing of the unit.
3. Connect cables as necessary (inside the connector bay - see FIG. 11 on page 11 and FIG. 12 on page 12).
4. Rotate the Acendo Vibe into seated position. The Bracket is secured with magnets (FIG. 13).

Connections

All connectors are located within the connector bay (rear panel).

- For surface installations, place the unit face-down and open the connector bay door to manage cables/connectors.
- For wall-mounted installations, simply rotate the Acendo Vibe unit down and away from the wall to access the connector bay.

There are two sets of connectors on the inner side panels of the connector bay. Each connector is labeled on the elastic cable straps. Run each cable through the cable pass-thru in the bracket/door and under the cable straps.

ACV-5100 Connectors

The connectors on the ACV-5100 are shown in FIG. 11: .

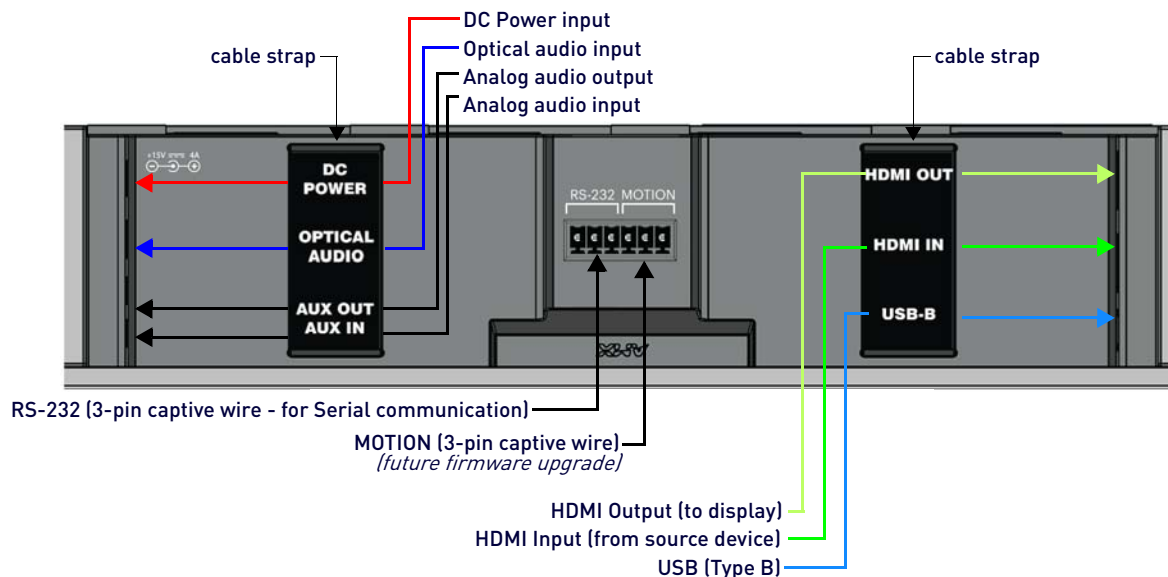

FIG. 11 ACV-5100 connector bay

ACV-5100 Connections	
DC POWER	Connect the included 15V $\overline{\text{---}}$ power supply to this barrel connector. Only use the power supply included with the ACV-5100.
OPTICAL AUDIO	Use this TOSLINK connector to receive Optical Stereo Input from an audio source device.
AUX OUT	Use this 1/8" mini-stereo connector to send analog stereo sound from the Acendo Vibe to an auxiliary device.
AUX IN	Use this 1/8" mini-stereo connector to receive analog stereo sound from an analog audio source device.
HDMI OUT	(Type A) Connect to an HDMI input on a display device.
HDMI IN	(Type A) Connect to an HDMI output from a source device, such as a laptop or Acendo Core.
USB	Use the USB 2.0 Type-B port to connect a PC/laptop to the Acendo Vibe as a source device. Acendo Vibe is plug-and-play with PC/laptop using standard UAC/UVC drivers. The USB connection is also used to configure the Acendo Vibe via the Acendo Vibe Configuration Tool for settings and firmware updates.
RS-232	3-pin captive-wire connector provides serial communication with the Acendo Vibe. Refer to the <i>Serial Commands</i> section on page 31 for command definitions. The Baud Rate for the RS-232 connector is 115200.
MOTION (future firmware upgrade)	3-pin captive-wire connector provides connectivity for an (optional) motion sensor (reserved for future implementation): <ul style="list-style-type: none"> • PWR (+5V $\overline{\text{---}}$ 0.1A) • OCC • Ground The logic of OCC is "High" for occupancy detected, and "Low" for vacancy.

Run each cable through the cable pass-thru in the bracket/door and under the cable strap

ACV-2100 Connectors

The connectors on the ACV-2100 are shown in FIG. 12: .

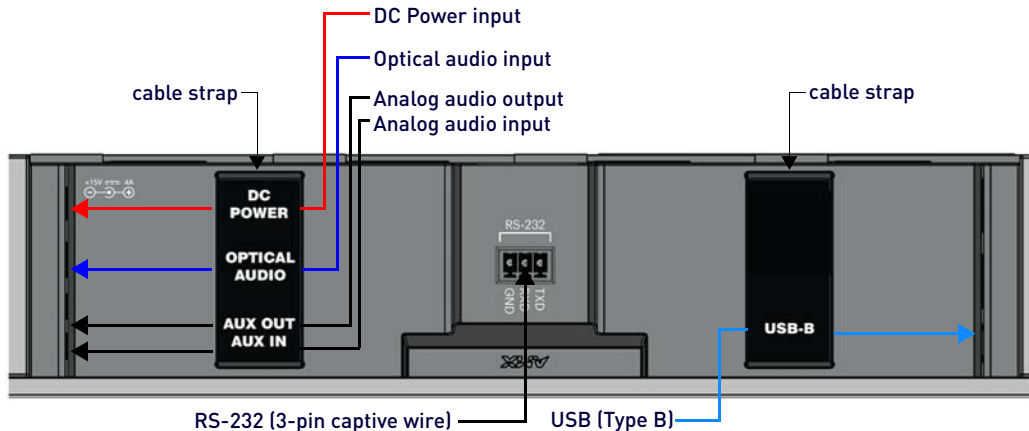

FIG. 12 ACV-2100 connector bay

ACV-2100 Connections	
DC POWER	Connect the included 15V power supply to this barrel connector. Only use the power supply included with the ACV-2100.
OPTICAL AUDIO:	Use this TOSLINK connector to receive Optical Stereo Input from an audio source device.
AUX OUT	Use this 1/8" mini-stereo connector to send analog stereo sound from the ACV-2100 to an auxiliary device.
AUX IN	Use this 1/8" mini-stereo connector to receive analog stereo sound from an analog audio source device.
USB	Use the USB 2.0 Type-B port to connect a PC/laptop to the ACV-2100 as a source device. Acendo Vibe is plug-and-play with PC/laptop using a standard UAC driver. The USB connection is also used to configure the ACV-2100 via the AMX Acendo Vibe configuration application and for file transfers.
RS-232	3-pin captive-wire connector provides serial communication with the Acendo Vibe. Refer to the <i>Serial Commands</i> section on page 31 for command definitions. The Baud Rate for the RS-232 connector is 115200.

Run each cable through the cable pass-thru in the bracket/door and under the cable strap.

Rotating the Acendo Vibe Into the Seated Position

After connecting all cables, close the Bracket to return the Acendo Vibe to its seated position. The Bracket is secured via internal magnets (FIG. 13):

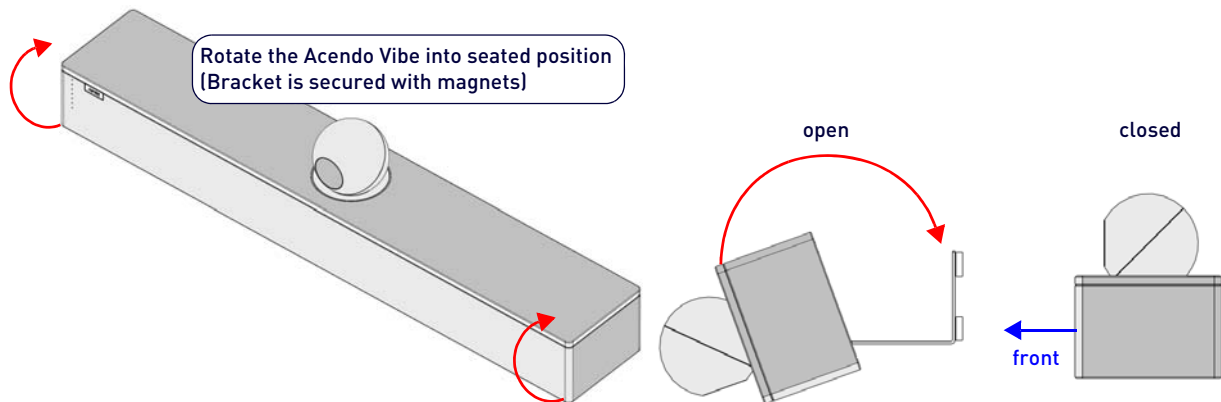

FIG. 13 Rotating the Acendo Vibe into its seated position

Installing Lock-Down Screws

The Acendo Vibe comes with two (flat-head) Lock-Down Screws that can be added after the Acendo Vibe has been installed and connected. The Lock-Down Screws prevent the Bracket from being opened accidentally. With the Bracket/connector bay door closed, install the Lock-Down Screws in the bottom panel (FIG. 14):

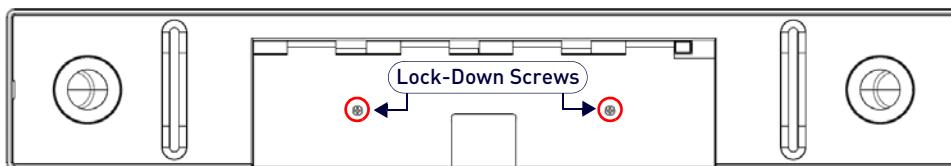

FIG. 14 Acendo Vibe Bottom View - Lock Down Screw Locations

NOTE: The Lock Down screws are not to be used to mount the Acendo Vibe unit to the wall.

Side Panel Keypad

All controls and LEDs are on the left side panel of the Acendo Vibe (FIG. 15):

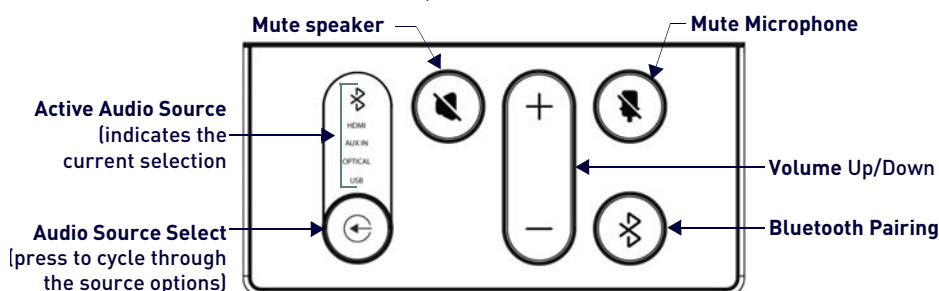

FIG. 15 Acendo Vibe LEFT SIDE PANEL Keypad

Volume and Mute Controls

The Acendo Vibe features Sound by JBL, including a 10W/channel stereo amplifier, speakers, microphones, and DSP algorithms with AEC

- Use the **Volume Up/Down** buttons on either the Acendo Vibe side panel or on the remote control to adjust speaker volume.
- **Mute Speaker** and **Mute Microphone** enable/disable the speakers and microphone. Note that these buttons are lit on the Acendo Vibe (and flash on the remote control) to indicate that the sound functions are muted.

Camera (ACV-5100 only)

The ACV-5100 is equipped with a wide-angle camera for videoconferencing and supports a wide range of web conferencing applications via USB. To configure your USB device, such as a laptop, to work with the Acendo Vibe:

1. Connect the Acendo Vibe to a laptop/PC via USB.
2. Use *Source Select* button on the the Acendo Vibe (FIG. 15) to select **USB** (if necessary).
3. Select **AMX Acendo Vibe** as the camera.
4. Select **AMX Acendo Vibe** as the microphone.
5. Select **USB AUDIO CODEC** as the speakers.

NOTE: To adjust the camera's view, simply grasp the camera and rotate to the desired position.

Remote Control

The Acendo Vibe includes a wireless remote control (FIG. 16):

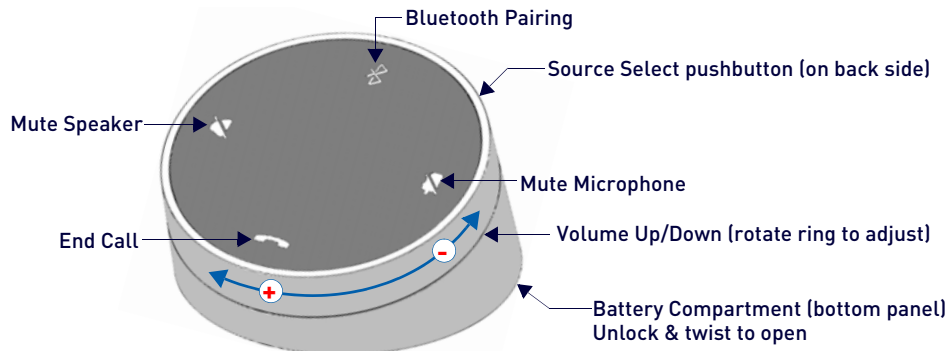

FIG. 16 Acendo Vibe Remote Control

Pairing the Remote Control to the Acendo Vibe

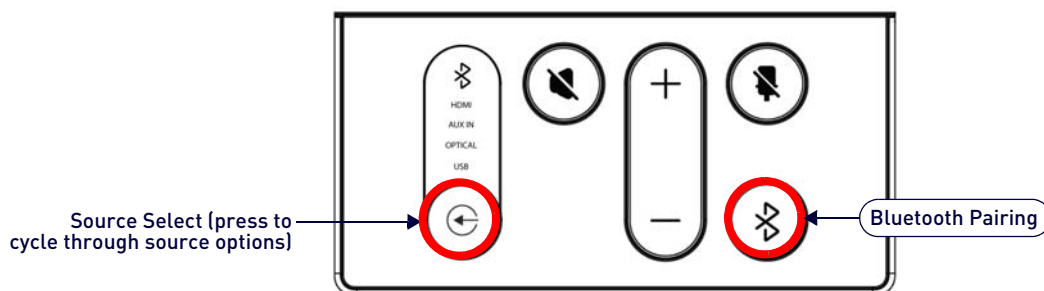

FIG. 17 Acendo Vibe LEFT SIDE PANEL Keypad

1. Press and hold both the **Source Select** and **Bluetooth Pairing** buttons on the *remote control* for 5 seconds (see FIG. 16). All LEDs on the remote control should start blinking or remain blinking (once per second).
2. Press and hold both the **Source Select** and **Bluetooth Pairing** buttons on the *Acendo Vibe* (see FIG. 15). After 3-5 seconds the LEDs on the remote control should stop flashing to indicate the remote control has paired.

NOTE: If the remote control remains in pairing mode (all LEDs blinking) for longer than 60 seconds the remote control will go to sleep. Press any button on the remote control to wake it up and continue with step 2.

Pairing the Acendo Vibe with a Bluetooth Source Device

1. Press the **Bluetooth Pairing** button on the Acendo Vibe or the remote control to initiate pairing (see FIG. 15). The Bluetooth button will flash on both the Acendo Vibe and the remote control.

NOTE: To exit pairing mode without pairing a device, press either Bluetooth button again for 5 seconds.
2. On the source device, verify that Bluetooth pairing is enabled, and look for "Acendo Vibe" (or custom discoverable name) as a found device. Select the *Acendo Vibe* device for pairing.

The Bluetooth LED on the Acendo Vibe side panel lights *solid* to indicate that the device is paired.

If automatic switching is disabled, use the *Source Select* button on the Acendo Vibe to select *Bluetooth* as the audio source (if necessary). At this point, the Bluetooth LED is lit *solid*, Bluetooth audio is sent to the Acendo Vibe speakers, and microphone audio is sent to the paired Bluetooth device.

NOTE: Once the Acendo Vibe has paired to a device, it must either be "removed" or "forgotten" from your device's Bluetooth pairing list before it can be paired again.

Setting the Acendo Vibe as the Default Audio Device

The Acendo Vibe can be set to be the default device for audio playback as well as recording and camera (Acendo Vibe only) on a PC/laptop/mobile device. This setting must be performed manually via the device's sound options.

Connecting RS232 for Serial Commands

Both Acendo Vibes feature a 3-pin captive-wire RS-232 connector that provides support for the Serial commands described in the *Serial Commands* section on page 31.

The RS-232 connector is located in the center of the Connector Bay (see FIG. 11 on page 11).

- TXD
- RXD
- GND

Connecting an External Motion Sensor (future firmware update / ACV-5100 only)

The ACV-5100 features a 3-pin captive-wire connector that provides connectivity for the future implementation of an (optional) motion sensor, located next to the RS-232 connector (see FIG. 11 on page 11).

- +5V
- DET (for Detect)
- Ground

The logic of DET is "High" for occupancy detected, and "Low" for vacancy.

Acendo Vibe Configuration Tool

The Acendo Vibe is configured via the *Acendo Vibe Configuration Tool* software (available to download from AMX). In most cases the default settings should not require adjustment. For details, see the *Acendo Vibe Instruction Manual*, available to view or download from www.amx.com.

Setup Mode

In order for the Acendo Vibe Configuration Tool to communicate with the Acendo Vibe, the unit must be in *Setup Mode*. See the *Entering Setup Mode* section on page 21 for details.

Configuring Acendo Vibe Conferencing Sound Bars

Overview

The ACV-2100/5100 Acendo Vibe Conferencing Sound Bars are configurable via the Acendo Vibe Configuration Tool software (available to download from www.amx.com). Note that there are two versions of the configuration software tool - one for PC and one for Mac.

NOTE: This document uses the Windows version of the software for illustration purposes, however the Mac version works identically.

The Acendo Vibe Configuration Tool organizes settings into four categories: *Bluetooth*, *Events* (ACV-5100 model only), *Audio* and *File*, as indicated in the Side menu bar along the left side of the application window (FIG. 18):

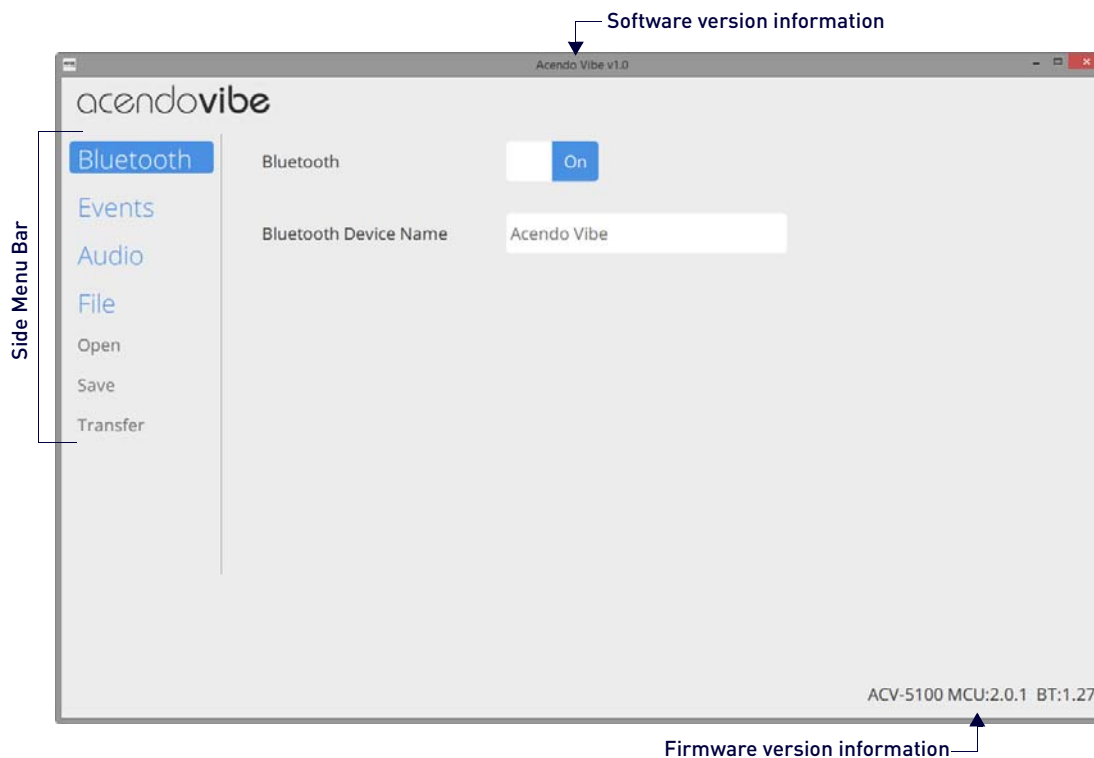

FIG. 18 Acendo Vibe Configuration Tool (Bluetooth options shown)

NOTE: In most cases the default settings should work fine without any need for adjustment. However, as part of the initial installation process, it is necessary to use the configuration software tool to commission each Acendo Vibe unit.

The Acendo Vibe unit must be in Setup Mode in order to communicate with the Acendo Vibe Configuration Tool. See the *Entering Setup Mode* section on page 21 for details.

- Bluetooth options are described on page 22.
- Events options are described on page 23.
- Audio options are described on page 24.
- File options are described on page 25.

Downloading and Installing the Acendo Vibe Configuration Tool

Go to the [ACV-2100](#) or [ACV-5100](#) product pages on the AMX Trade site and click the **Acendo Vibe Configuration Software** link to download the installation file.

1. Download the installation file to a known location.
2. Double-click the installation (*.exe) file and follow the on-screen directions to install:
 - a. In the *Welcome to the Acendo Vibe Setup Wizard* dialog, click **Next** to proceed (FIG. 19):



FIG. 19 Welcome to the Acendo Vibe Setup Wizard dialog

- b. Read and accept the *License Agreement*, and click **Next** to proceed (FIG. 20):

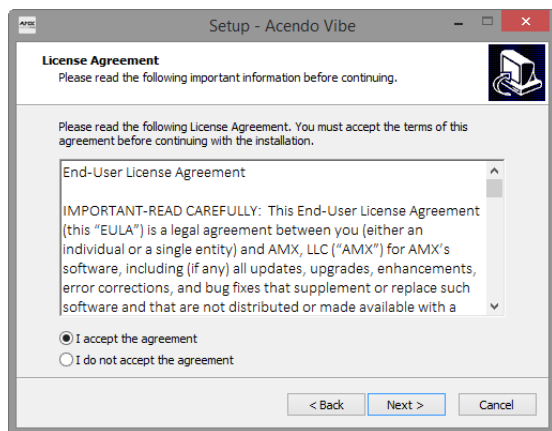

FIG. 20 Acendo Vibe Setup Wizard - License Agreement dialog

- c. Select a destination folder for this installation (or leave the default folder setting) and click **Next** to proceed (FIG. 21):

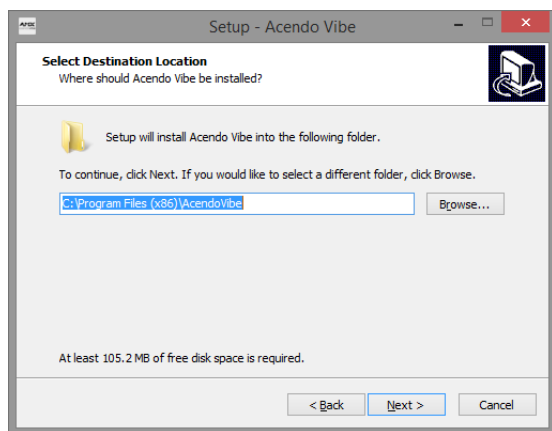

FIG. 21 Acendo Vibe Setup Wizard - Select Destination Location dialog

- d. Select a Start Menu folder folder for this installation (or leave the default folder setting) and click **Next** to proceed (FIG. 22):

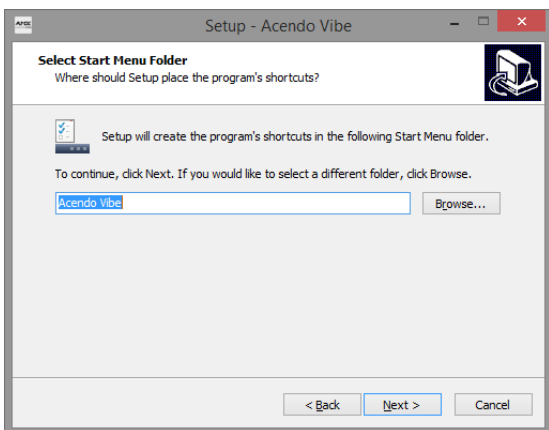

FIG. 22 Acendo Vibe Setup Wizard - Select Start Menu Folder dialog

- e. By default, the installation will create a desktop shortcut: de-select this option if desired and click **Next** to proceed (FIG. 23):

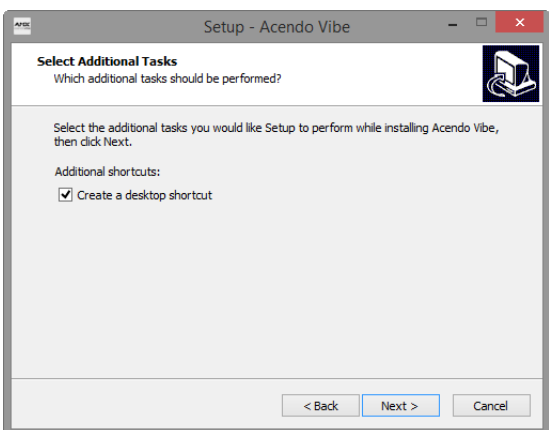

FIG. 23 Acendo Vibe Setup Wizard - Select Additional Tasks

- f. In the *Ready to Install* dialog, click **Install** (FIG. 24):

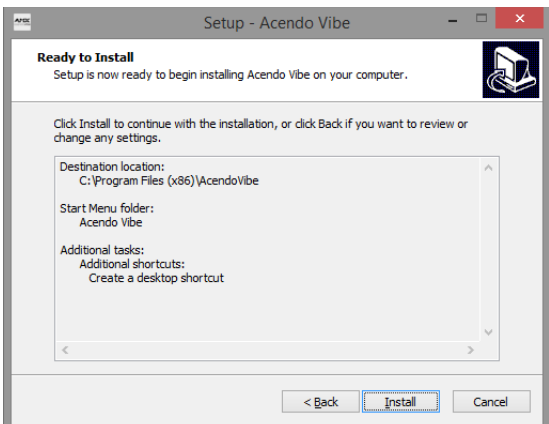

FIG. 24 Acendo Vibe Setup Wizard - Ready to Install dialog

3. This selection invokes the first of two *Device Driver Installation Wizards* (FIG. 25). These Wizards install the two device drivers required by the Acendo Vibe.

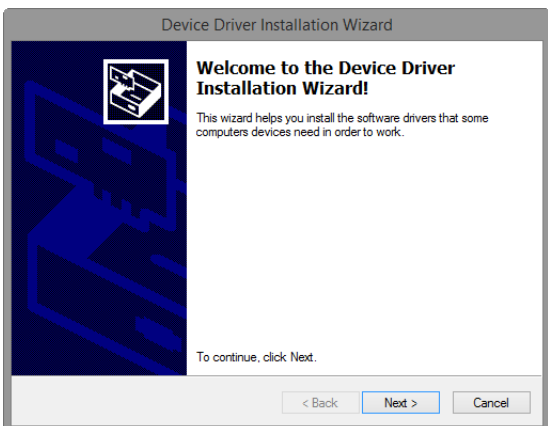

FIG. 25 Device Driver Installation Wizard (1 of 2) - Welcome dialog

4. Click **Next** to proceed (FIG. 26):

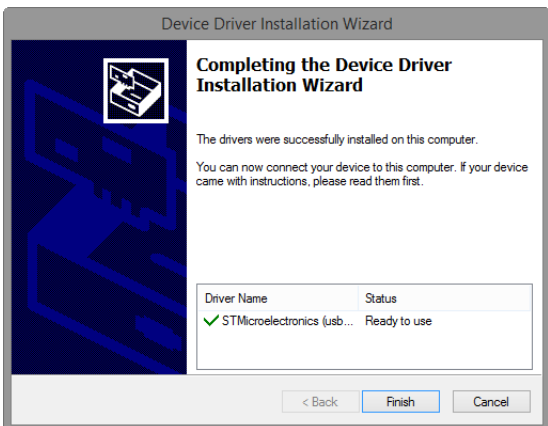

FIG. 26 Device Driver Installation Wizard (1 of 2) - Completing the Device Driver Installation Wizard dialog

5. Click **Finish** to close this dialog and open a second Device Driver Installation Wizard that installs the second device driver (FIG. 27):

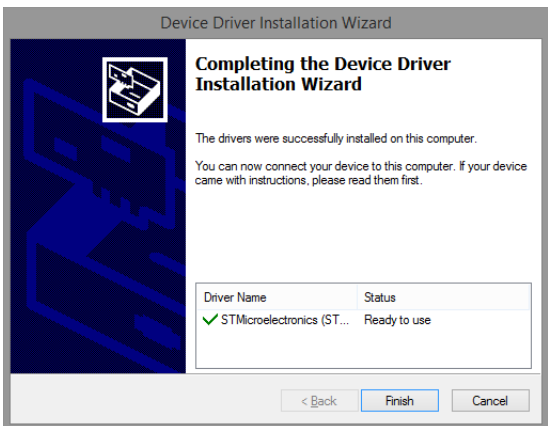

FIG. 27 Device Driver Installation Wizard (2 of 2) - Completing the Device Driver Installation Wizard dialog

6. Click **Finish** to close the Device Driver Installation Wizard and return to the final *Acendo Vibe Setup Wizard* dialog (FIG. 27):



FIG. 28 Acendo Vibe Setup Wizard - Completing the Acendo Vibe Setup Wizard

Note that by default, both options in this dialog are selected:

- **View Readme.txt** - When the *Finish* button is clicked, the release notes for this release are opened.
- **Launch Acendo Vibe 1.x.x** - When the *Finish* button is clicked, the Acendo Vibe Configuration Tool is launched automatically.

7. Click **Finish** to close the Setup Wizard. Assuming that the options above are selected, the *Readme.txt* file is displayed, and the Acendo Vibe Configuration Tool is launched.

NOTE: Assuming that the Acendo Vibe is not yet connected to the PC running the Configuration Tool via USB, the Setup Mode window (see FIG. 31 on page 21) is presented.

Connecting to the the Acendo Vibe via USB

The Acendo Vibe Configuration Tool communicates with the Acendo Vibe via the USB port.

NOTE: It is not necessary to have an Acendo Vibe connected to the PC to use the Configuration Tool. The software provides the ability to create and save configuration (*.json) files, and then transfer them to one or more Acendo Vibe units at a later time. See the File Options (Open, Save and Transfer) section on page 25 for details.

Accessing the USB Connector

- For surface installations, place the unit face-down and open the Connector Bay Door to manage cables/connectors.
- For wall-mounted installations, rotate the Acendo Vibe unit down and away from the wall to access the Connector Bay. The USB-B port is labeled on the elastic cable strap (FIG. 29):

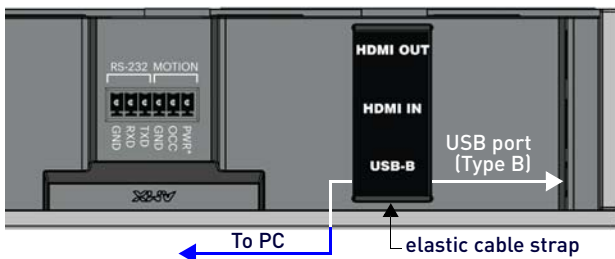

FIG. 29 Acendo Vibe Connector bay - Detail (ACV-5100 shown)

1. With the Acendo Vibe powered on, plug a USB cable connected to the host PC (on which the Acendo Configuration Tool software is installed) into the USB port on the Acendo Vibe.
2. Check the lower-right corner of the configuration tool window for current firmware version information. If the Acendo Vibe is not connected, the message "*Not connected*" is displayed instead. (FIG. 30):



FIG. 30 USB Connection Status: Connected / Not Connected

Entering Setup Mode

The Acendo Vibe unit must be in *Setup Mode* in order to communicate with the Acendo Vibe Configuration Tool. Follow the instructions presented on the *Setup Mode* window to place the Acendo Vibe unit into Setup Mode (FIG. 31):

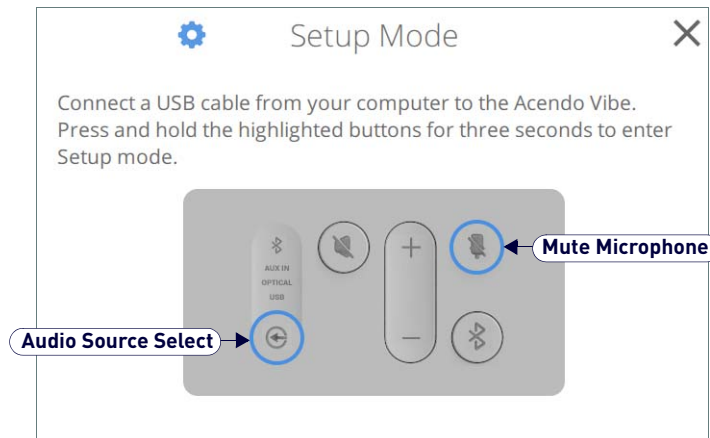

FIG. 31 Acendo Vibe Configuration Tool - initial view (Setup Mode window)

NOTE: When the Configuration Tool is launched, the Setup Mode window is presented.

1. Connect a USB cable from the PC running the Configuration Tool software to the USB port on the Acendo Vibe.
2. Press and hold the **Audio Source Select** and **Mute Microphone** buttons for three seconds. All of the button LEDs blink to indicate that the unit is in Setup Mode.
3. Close the Setup Mode window to access the main Configuration Tool.

NOTE: It is not necessary to have a Acendo Vibe connected to the PC to use the Configuration Tool. The software provides the ability to create and save configuration (*.json) files, and then transfer them to one or more Acendo Vibe units at a later time. See the File Options (Open, Save and Transfer) section on page 25 for details.

Exiting Setup Mode

To exit Setup mode, press and hold the **Audio Source Select** and **Mute Microphone** buttons for 3 seconds.

USB Connected Window

When the Acendo Vibe connects to the PC via USB, the *USB Connected* window is invoked. Select a file transfer option (FIG. 32):

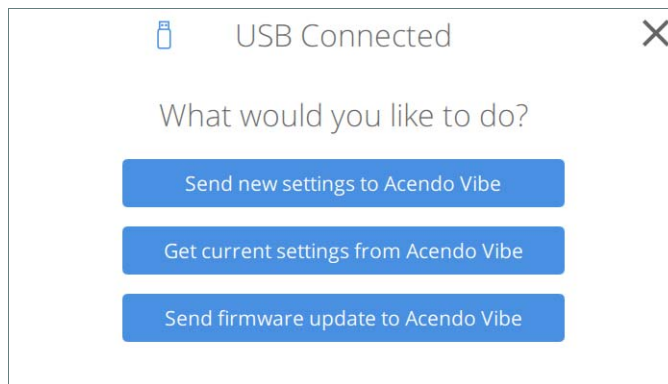

FIG. 32 USB Connected window - What would you like to do?

- **Send new settings to Acendo Vibe:** Click to send an existing settings (*.json) file to the Acendo Vibe. See the *Sending New Settings to Acendo Vibe* section on page 28 for details.
- **Get current settings from Acendo Vibe:** Click to retrieve the current settings from the Acendo Vibe, in the form of a *.json file. See the *Getting Current Settings From Acendo Vibe* section on page 29 for details.
- **Send firmware update to Acendo Vibe:** Click to transfer a firmware update to the Acendo Vibe. See the *Sending Firmware Update to Acendo Vibe* section on page 29 for details.

Transfer Options Window

Note that the options described above are also available via the *Transfer Options* window. In cases where the Acendo Vibe unit is already connected to the PC via USB, select the **File > Transfer** option in the side menu of the main Acendo Vibe Configuration Tool to open the *Transfer Options window* (FIG. 33):

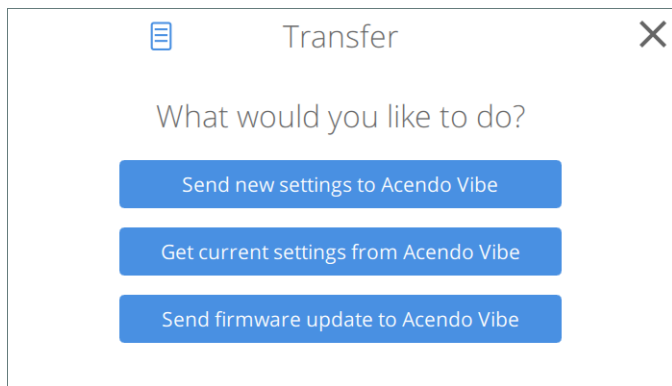

FIG. 33 Transfer Options window - What would you like to do?

- **Send new settings to Acendo Vibe:** See the *Sending New Settings to Acendo Vibe* section on page 28.
- **Get current settings from Acendo Vibe:** See the *Getting Current Settings From Acendo Vibe* section on page 29.
- **Send firmware update to Acendo Vibe:** See the *Sending Firmware Update to Acendo Vibe* section on page 29.

Bluetooth Configuration Options

Select **Bluetooth** from the side menu to access the Bluetooth configuration options (FIG. 34):

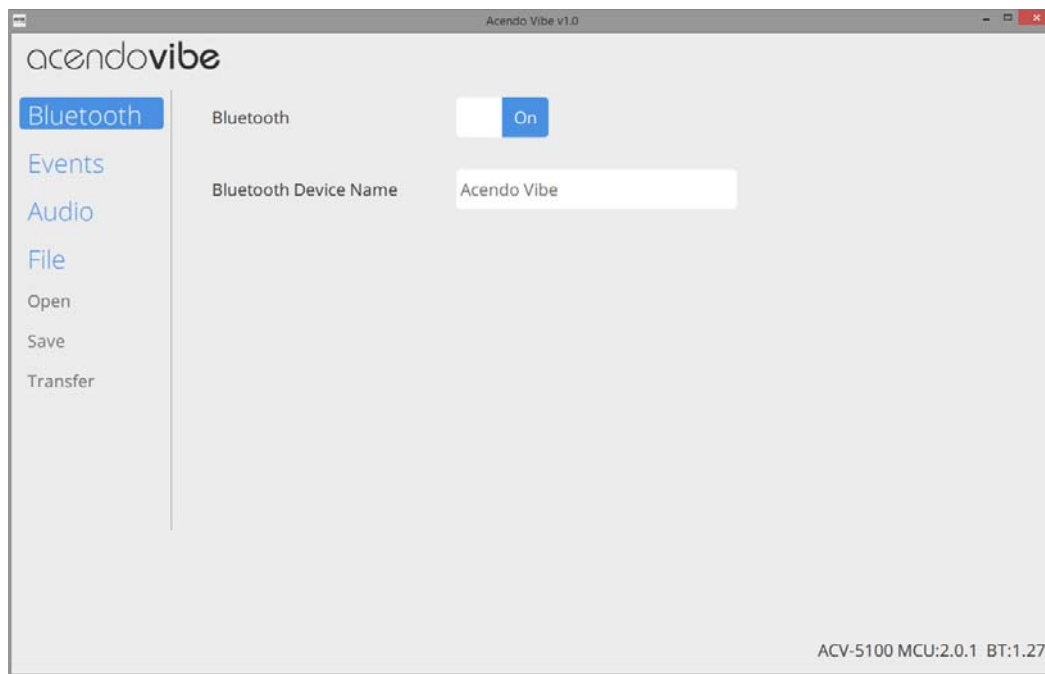

FIG. 34 Acendo Vibe Configuration Tool - Bluetooth Configuration Options

These options enable/disable Bluetooth functionality as well as rename the connected Acendo Vibe unit:

Bluetooth Configuration Options	
Bluetooth (On/Off)	Click to toggle from On to Off (default = On).
Bluetooth Device Name	Enter a new name for the Acendo Vibe unit (up to 30 characters). This is the device name that will indicate this Acendo Vibe on the Bluetooth network. The default is "Acendo Vibe". Note: Changing this setting will force a reboot of the Acendo Vibe unit.

Events Configuration Options (ACV-5100 only)

The Events options are only available for ACV-5100 Acendo Vibe Sound Bar with Camera. Select **Events** from the side menu to access Events configuration options (FIG. 35):

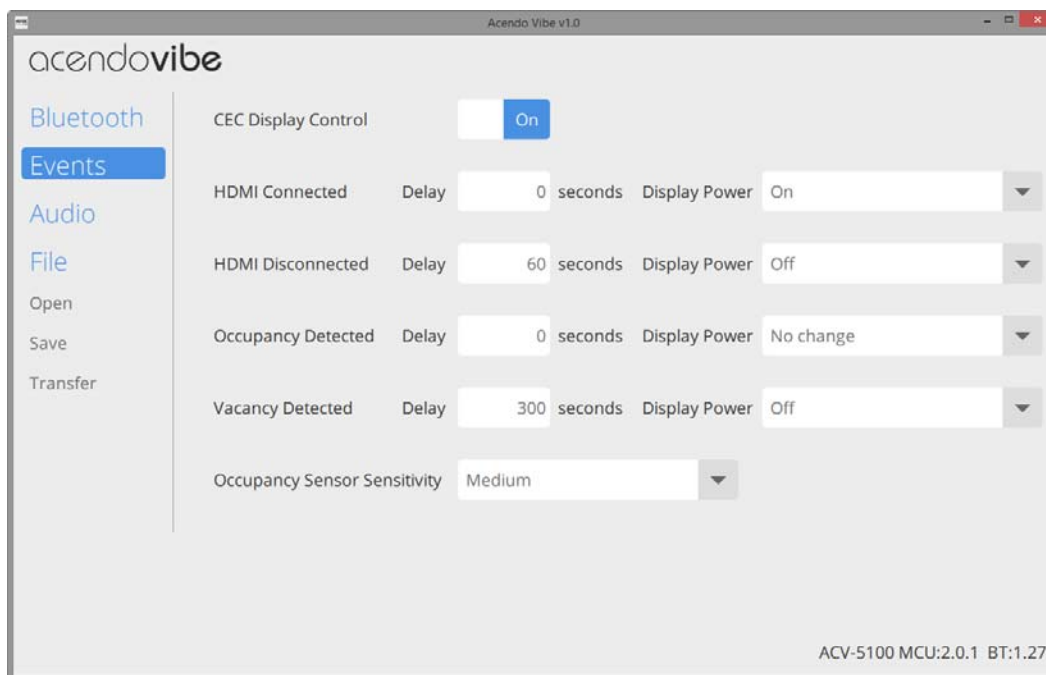

FIG. 35 Acendo Vibe Configuration Tool - Events Configuration Options (ACV-5100 only)

These options configure how CEC operates relative to defined events, and adjust Occupancy Sensor settings:

Events Options (ACV-5100 only)	
CEC Display Control	Click to toggle from On to Off (default = On). Note that when CEC Display Control is off, the other options on this page are disabled.
HDMI Connected	By default, the HDMI display device is powered on when the HDMI connector is plugged into the Acendo Vibe (via CEC display control). <ul style="list-style-type: none"> • Delay: Set a delay time (in seconds) for the Display Power action (range: 0-300 seconds, default = 0). • Display Power: From the drop-down menu, select a Display Power action to be triggered by connecting HDMI. The options are On (default setting), Off and No Change.
HDMI Disconnected	By default, the HDMI display device is powered off when the HDMI connector is unplugged from the Acendo Vibe (via CEC display control). <ul style="list-style-type: none"> • Delay: Set a delay time (in seconds) for the Display Power action (range: 0-300 seconds, default = 60). • Display Power: From the drop-down menu, select a Display Power action to be triggered by connecting HDMI. The options are On, Off (default setting) and No Change.
Occupancy Detected	The ACV-5100 features an internal sound sensor that provides occupancy sensing functionality. <i>Note that this internal sound sensor is separate and unrelated to any external sensor that may be connected to the Acendo Vibe via the 3-pin MOTION connector.</i> <p>By default, the HDMI display device does not turn on or off based on occupancy detected by the Acendo Vibe’s internal sound sensor . Use this option to set a Display Power action to take effect when the internal sound sensor detects occupants in the room (via CEC display control).</p> <ul style="list-style-type: none"> • Delay: Set a delay time (in seconds) for the Display Power action (range: 0-300 seconds, default = 0). • Display Power: From the drop-down menu, select a Display Power action to be triggered by the internal sound sensor detecting people in the room. The options are No Change (default setting), On and Off.
Vacancy Detected	By default, the HDMI display device is turned off when the Acendo Vibe’s internal sound sensor detects vacancy (no occupants) in the room (via CEC Display Control). Use this option to change the Display Power action to take effect when the internal sound sensor detects vacancy. <ul style="list-style-type: none"> • Delay: Set a delay time (in seconds) for the Display Power action (range: 0-300 seconds, default = 300). • Display Power: From the drop-down menu, select a Display Power action to be triggered by the internal sound sensor detecting vacancy in the room. The options are Off (default setting), On and No Change.
Occupancy Sensor Sensitivity	Use this drop-down menu to specify a level of sensitivity for the Acendo Vibe’s internal sound sensor or to turn off occupancy sensing: <ul style="list-style-type: none"> • Off - Disables internal occupancy sensing • Low, Medium (default setting) and High.

Audio Configuration Options

Select **Audio** from the side menu to access the Audio Configuration Options (FIG. 36):

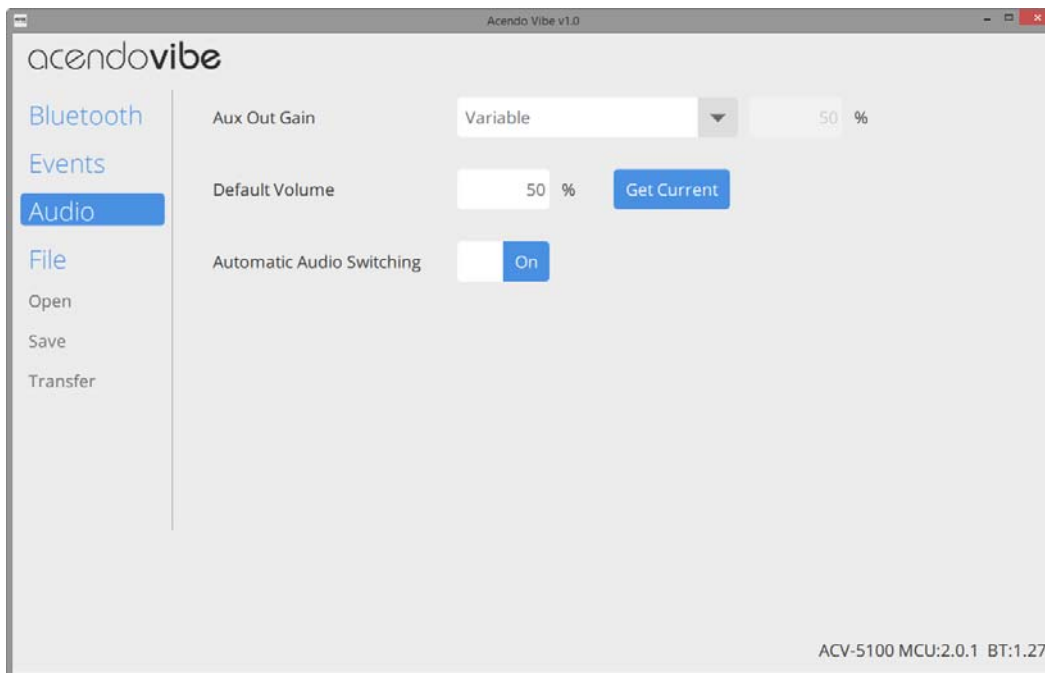

FIG. 36 Acendo Vibe Configuration Tool - Audio Configuration Options

These options toggle Automatic Auto Switching as well as adjust the default volume and gain settings for the Aux Out connector:

Audio Options	
Aux Out Gain	From the drop-down menu, select <i>Variable</i> (default setting) or <i>Fixed</i> . <ul style="list-style-type: none"> When <i>Variable</i> is enabled, the aux out gain will follow the speaker volume. When <i>Fixed</i> is selected, the value (%) field is enabled - enter a value for gain on the Aux out port (0-100).
Default Volume	Enter a value for the default output volume for this Acendo Vibe unit (0-100, default = 50).
Automatic Audio Switching	Click to toggle from On to Off (default = On).

File Options (Open, Save and Transfer)

Use the File options to **save** the current settings (as a *.json config file), **open** an existing config (*.json) file, and **transfer** the current settings to an Acendo Vibe via USB connection (FIG. 37):

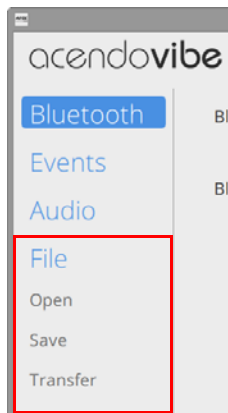

FIG. 37 Acendo Vibe Configuration Tool - File options

Opening an Existing Acendo Vibe Configuration File

Saved Acendo Vibe Configuration Files (*.json) can be opened to view and/or modify the settings as desired, or to be transferred to the Acendo Vibe in order to quickly configure the unit:

1. In the Side menu, click **File > Open** (FIG. 41):

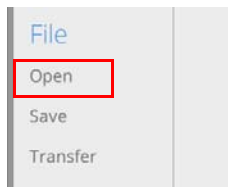

FIG. 38 File → Open

2. This selection invokes the *Open Settings* dialog (FIG. 39):

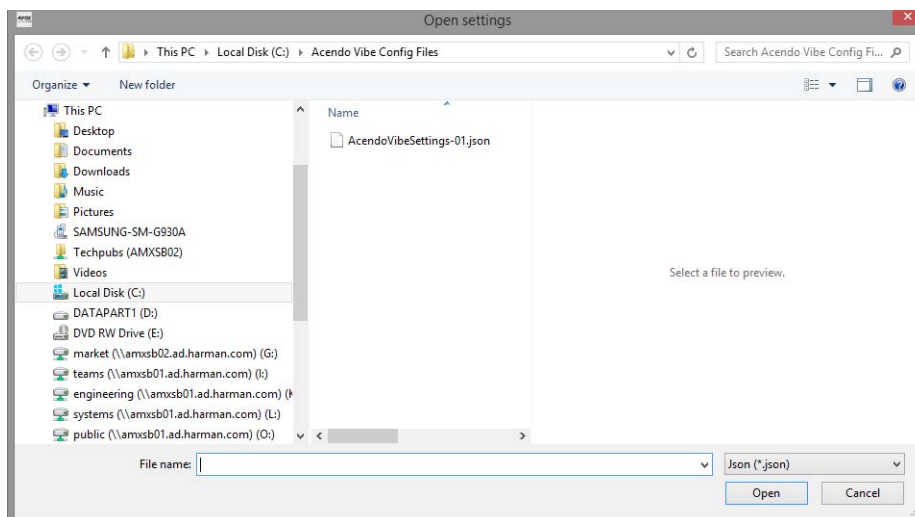

FIG. 39 Open Settings dialog

3. Locate and select the desired Acendo Vibe Configuration File and click **Open** to invoke the *File Open options* window to specify whether to transfer or simply open the selected (*.json) file (FIG. 40):

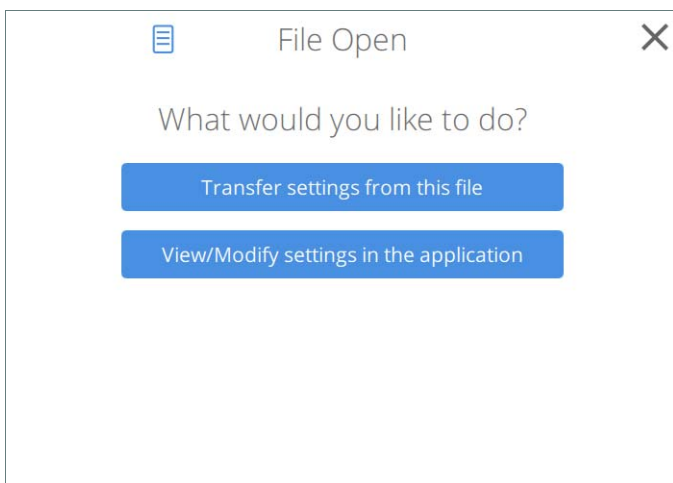

FIG. 40 File Open Options window - What would you like to do?

- Click **Transfer settings from this file** to transfer the selected Acendo Vibe Configuration (*.json) file. See the *Transfer settings from this file* section on page 27 for details.
- Click **View/Modify settings in the application** to view and/or modify the settings defined in the selected Acendo Vibe Configuration file in the Acendo Vibe Configuration Tool. See the *Viewing/Modifying an Acendo Vibe Configuration File* section on page 27 for details.

Saving Settings as an Acendo Vibe Configuration File

Once the Acendo Vibe settings have been configured, these settings can be saved as an Acendo Vibe Configuration File with the extension *.json:

1. In the Side menu, click **File > Save** (FIG. 41):

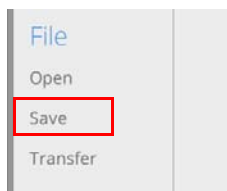

FIG. 41 File → Save

2. This selection invokes the *Save settings* dialog (FIG. 42):

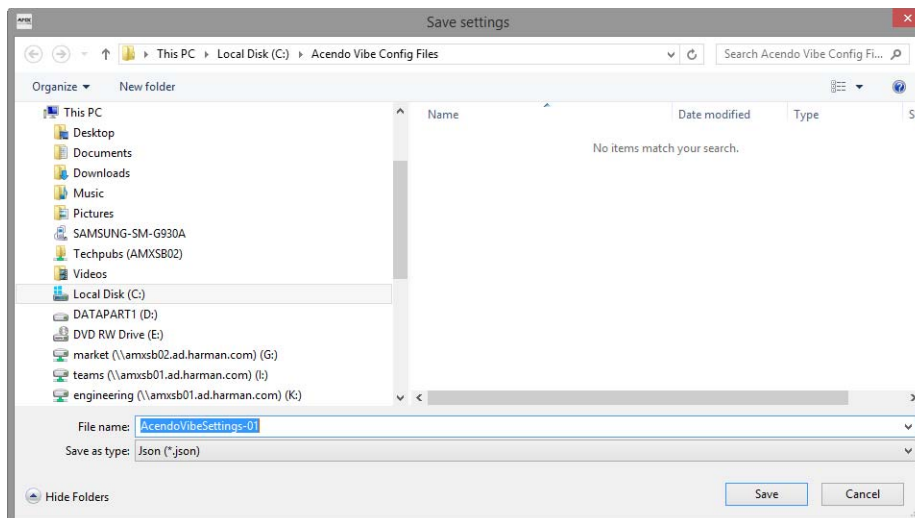

FIG. 42 Save As dialog

3. Select a target folder and assign a File Name to the file. Note that the file extension is automatically set to *.json.
4. Click **Save** to save the file and close this dialog.

Transfer settings from this file

1. In the Side menu, click **File > Transfer** (FIG. 43):

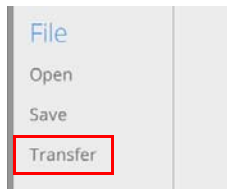

FIG. 43 File → Transfer

NOTE: Alternatively, click "Transfer settings from this file" in the File Open window (see FIG. 40).

2. This selection invokes the Transfer Options window (see FIG. 47 on page 28).
3. The settings as configured in the currently open Acendo Vibe Configuration File are sent to the connected Acendo Vibe unit.

The system indicates the progress of this transfer, and indicates when the transfer is complete (FIG. 44):

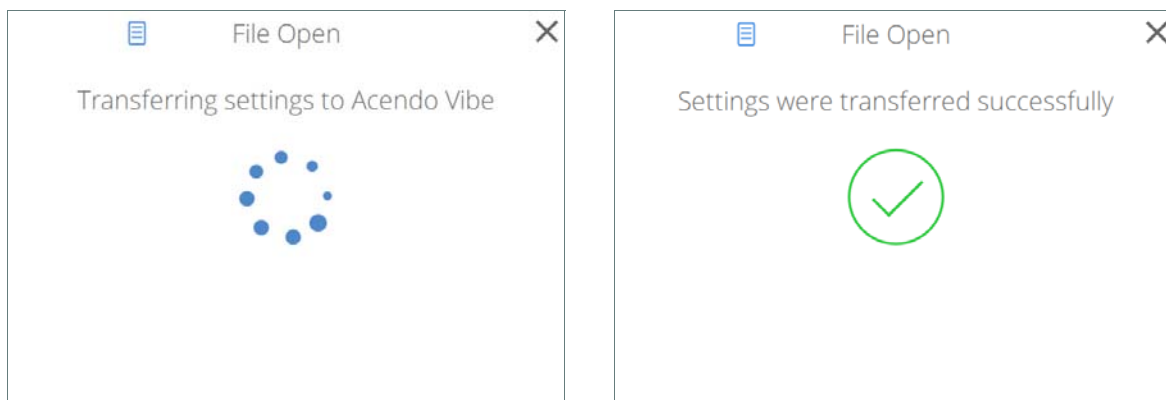

FIG. 44 Transfer - Transferring settings to Acendo Vibe unit

- The system will indicate if there was an error transferring the files. In this case, refer to the *Troubleshooting* section on page 39.
- If a device name changes, the system indicates that a restart of the Acendo Vibe unit is required (FIG. 45):

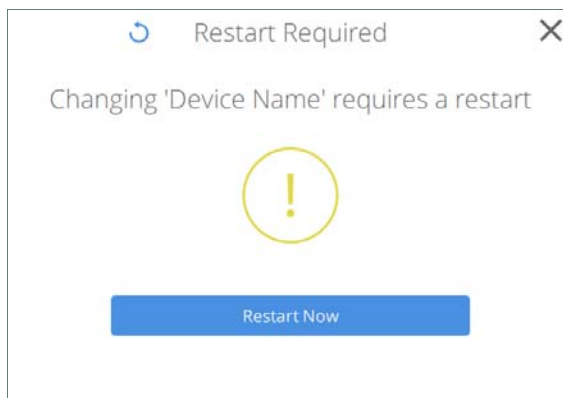

FIG. 45 Transfer - Restart Required

4. Close the *File Open* window.

Viewing/Modifying an Acendo Vibe Configuration File

1. In the *File Open* window, click **View/Modify settings in the application** (see FIG. 40).
2. The selected Acendo Vibe Configuration File is opened in the Acendo Vibe Configuration Tool.
3. View and/ modify settings as desired:
 - See the *Bluetooth Configuration Options* section on page 22
 - See the *Events Configuration Options (ACV-5100 only)* section on page 23
 - See the *Audio Configuration Options* section on page 24

NOTE: To save changes, click **File > Save** in the Side menu (see FIG. 38 on page 25).

Sending New Settings to Acendo Vibe

NOTE: The new settings will replace the existing settings on the connected Acendo Vibe.

1. In the Side menu, click **File > Transfer** (FIG. 46):

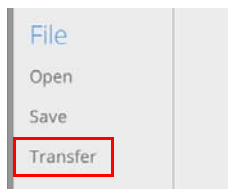

FIG. 46 File → Transfer

2. This selection invokes the *Transfer options* window to specify whether to transfer an Acendo Vibe Configuration File to or from the connected unit, or to send a firmware update to the Acendo Vibe (FIG. 47):

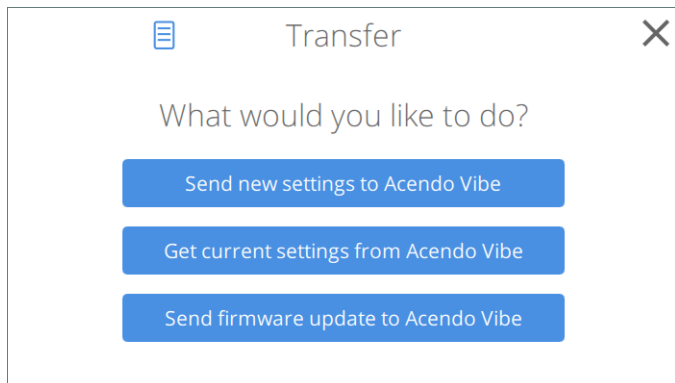

FIG. 47 Transfer Options window - What would you like to do?

- Click **Send new settings to Acendo Vibe** to transfer a selected Acendo Vibe Configuration (*.json) file. See the *Transfer settings from this file* section on page 27 for details.
 - Click **Get current settings from Acendo Vibe** to view and/or modify the settings defined in the selected Acendo Vibe Configuration file in the Acendo Vibe Configuration Tool. See the *Getting Current Settings From Acendo Vibe* section on page 29 for details.
 - Click **Send firmware update to Acendo Vibe** to view and/or modify the settings defined in the selected Acendo Vibe Configuration file in the Acendo Vibe Configuration Tool. See the *Sending Firmware Update to Acendo Vibe* section on page 29 for details.
3. In the *Transfer Options* window, select **Send new settings to Acendo Vibe** (see FIG. 47).
 4. The current settings (as currently configured in the Settings application) are sent to the Acendo Vibe. The system indicates the progress of this transfer, and indicates when the transfer is complete (FIG. 48):

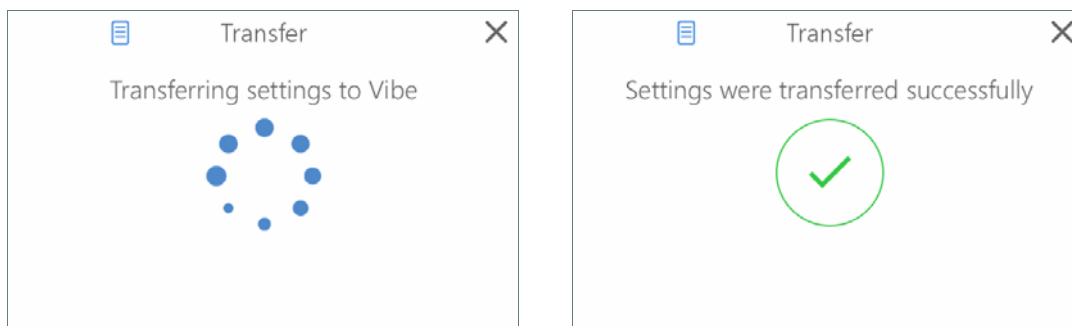

FIG. 48 Transfer - Transferring settings to Acendo Vibe

NOTE: The system will indicate if there was an error transferring the files. In this case, refer to the *Troubleshooting* section on page 39.

5. Close the *Transfer* window.

Getting Current Settings From Acendo Vibe

To retrieve the current configuration settings from the Acendo Vibe:

1. In the *USB Connected* (or *Transfer*) dialog, select **Get current settings from Acendo Vibe** (see FIG. 32).
2. The current settings (as currently configured in the Settings application) are retrieved from the Acendo Vibe. The system indicates the progress of this transfer (FIG. 49):

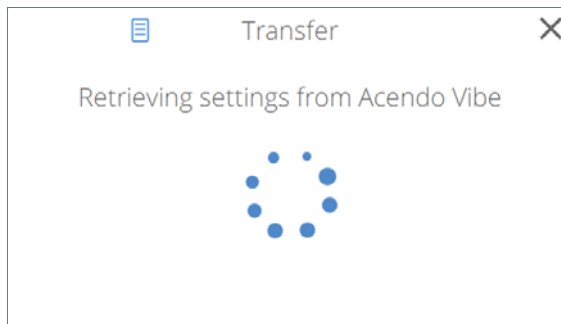

FIG. 49 Transfer - Retrieving settings from Acendo Vibe

NOTE: The system will indicate if there was an error transferring the files. In this case, refer to the *Troubleshooting* section on page 39.

3. The *Transfer - Retrieving settings from Acendo Vibe* dialog closes automatically when the transfer is complete.

Sending Firmware Update to Acendo Vibe

The Acendo Vibe utilizes two firmware files: Acendo Vibe firmware and BT firmware. The current version numbers of both firmware files are indicated in the lower-right corner of the main application window (FIG. 50):

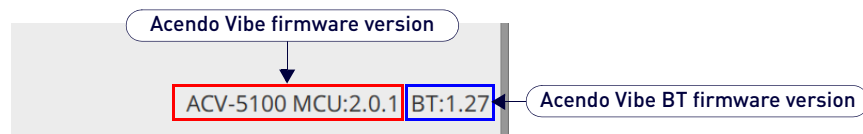

FIG. 50 main application window (detail) - Acendo Vibe firmware and BT firmware version information

NOTE: the *Acendo Vibe Configuration Tool* requires firmware files to be in a ZIPPED format (*.ZIP). MAC systems that are set to automatically unzip ZIP files must be reconfigured to leave these file ZIPPED.

To send a firmware file to update the Acendo Vibe:

1. In the *USB Connected* (or *Transfer*) window, select **Send firmware update to Acendo Vibe** (see FIG. 47).
2. In the *Choose firmware file* dialog, select a firmware (*.ZIP) file to transfer.
3. Click **Open**. The system will prompt you to verify this action before the firmware is transferred (FIG. 51):

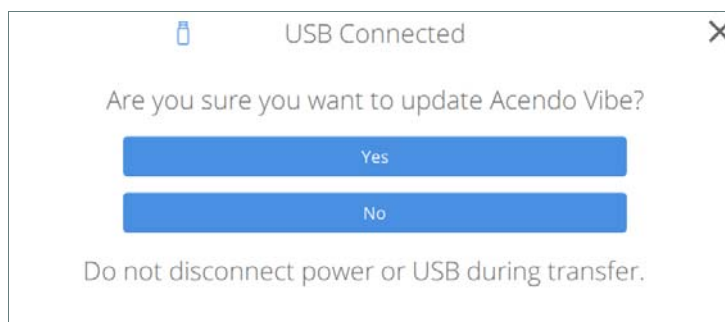

FIG. 51 Transfer - Are you sure you want to update Acendo Vibe?

4. Click **Yes** it to proceed (or select *No* to cancel this operation). The system indicates the progress of this transfer, and indicates when the transfer is complete (FIG. 52):

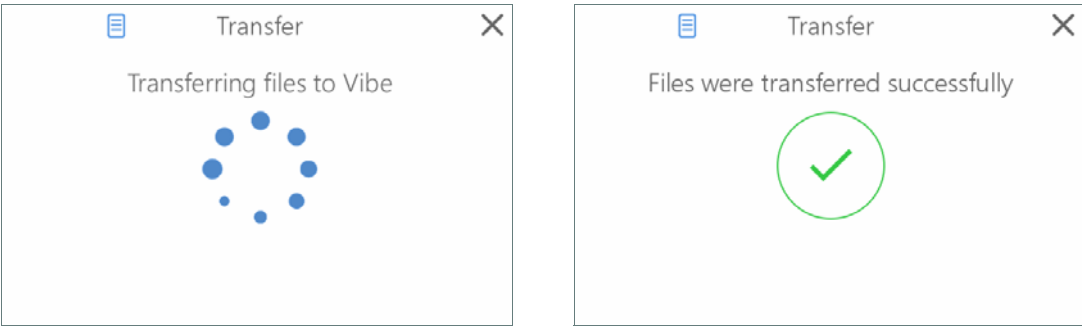

FIG. 52 Transfer - Transferring files to Acendo Vibe

NOTE: The system will indicate if there was an error transferring the files. In this case, refer to the *Troubleshooting* section on page 39.

- 5. Close the *Transfer* dialog.

Serial Commands

Overview

Acendo Vibe supports a set of Serial commands that can be sent to the unit via the 3-pin captive-wire RS-232 connector on the rear of the Acendo Vibe unit (see FIG. 11 on page 11).

RS-232 Connector Specifications

NOTE: *The Acendo Vibe RS-232 connector settings are: 115,200 baud, 8 data bits, no parity and one stop bit. These settings cannot be changed.*

Command Protocol

Protocol Definition

The Acendo Vibe control protocol is a text based protocol.

The protocol is command/response from client to server and from server to client. A client can send one command to the server, then it must wait for a response from the server before sending another command. In the meantime, the server can send one command to the client, but must wait for a response from the client before sending another command.

Syntax

The general syntax of a Acendo Vibe message is:

```
<Command/Reply> [ <Argument> ]*
```

Spaces are used as delimiters between the items in a message and the message is terminated by any of the following:

- carriage return (\r)
- newline (\n)
- carriage return (\r) followed by newline (\n)

If any command or arguments contain a space or newline, it must be surrounded by double quotes ("). If the double quote (") appears in an argument, it must be escaped with a backslash (\).

Leading and trailing spaces on all parameters and commands are stripped and not preserved. Embedded spaces are preserved, so keys and names and so on can have embedded spaces.

Case Sensitivity

- Case-insensitive: commands, replies, paths, names, message-forwarding info.
- Case-sensitive: parameters.

NOTE: *The protocol is not case sensitive but it can be case preservative in that when replying to messages you could use the same case as in the original command. However, this is not a hard requirement.*

Path Syntax

A crucial concept is that of a path name. The path name is the name given to an element. The path name includes the path and the name of the element. A forward slash "/" is used to distinguish hierarchy in the path name. Paths can be surrounded by double quotes if required due to white space in the path. An example of a path name is:

```
"/Audio/P1/Channel 1/Gain"
```

The forward slash at the start indicates that the path is absolute. If the path is a relative path to the current working path, the first forward slash will not be present.

Command / Reply

A command is a path (with possibly only one node). Each command has a specific reply. The reply pre-pends "@" to the original command to form the reply. This pre-pending makes it easy for a parser to quickly distinguish a reply command.

```
COMMAND
@COMMAND
```

Parameters

Parameters are separated by the space delimiter. If wanting spaces inside a parameter, use quotes. If wanting quotes inside a parameter, use the \" escape sequence. While inside quotes, newlines will be preserved and ignored. Outside of quotes, a newline terminates the line.

Unsupported command reply

When a well-formed command that is not applicable to the particular Acendo Vibe model (A, V or R) is received, e.g. a video command to an A model, Acendo Vibe will return an unsupported command reply, as follows:

```
@Unsupported <entire offending message>
```

Getting and setting values

Paths

The following tree represents the paths in Acendo Vibe.

```

audmic
  state
audio
  autoswitch
  defvolume
  gain
    mode
    level
  source
  state
  volume
battery
  state
bluetooth
  connstate
  hangup
  pairing
  state
camera
  state
display
  state
occupancy
  internal
    state
  external
    state
  sensitivity
ringleads
  state
  color
system
  name
  firmware
    update
  model
  reboot
  versions
trigger
  hdmiconn
    action
    delay
  hdmidis
    action
    delay
  occupancy
    action
    delay
  vacancy
    action
    delay
usbup
  status
video
  cec
  status

```

Execute command

```
exec <path> <arguments>
```

The response is

```
@exec <path> <arguments>
```

Get value

```
Get <path>
```

The response is

```
@Get <path> <value>
```

Set value

Can be a request to set a particular value, or if preceded by @, it is the response to the SetValue. Responses are necessary for throttling, or for error message returns ("Parameter not found", for example).

```
Set <path> <value>
```

Where path is ., .., relative, or absolute path if starting with "/". Includes the name of the item.

The reply to set is

```
@Set <path> <value>
```

For the reply, path is echoed back. The value may be different than what was set, for example if rounding occurred or the value simply changed to something else.

Errors

Error reply

The Error reply contains an error message if a parameter is not found with the last command. Always starts with "@" - this is a reply to any command that was invalid. The stuff that comes after @Error is the entire original message as-is. (No extra quotes except what was in the original message.) Then there is one extra parameter at the end, which is the error message.

```
@Error <entire client message> <error string>
```

For example:

```
Set nothing 2
@Error set nothing 2 "Attribute not found"
```

Unrecognized command reply

Sent whenever an unrecognized command comes in, e.g. user misspelling.

```
@Unrecognized <entire offending message>
```

Events

An Event is a message that comes from the Server to the Client. There is no reply to an Event message.

```
Event <Event Name> <Event Data>
```

Serial Commands

Acendo Vibe supports the Command Protocol on both its USB and RS-232 interfaces.

Note: Events are only reported on the RS-232 interface (see the Events section on page 38).

The following tables describe the Serial commands supported by Acendo Vibe.

NOTE: Commands in italics may be generated by the commissioning tool. However, they may also be entered on any of the command interfaces.

Serial Commands - ACV-2100 & ACV-5100

- The first table includes commands that apply to both the ACV-2100 and ACV-5100.
- ACV-5100-specific commands begin on page 35.

Serial Commands - ACV-2100 & ACV-5100	
Command	Description
get /audio/autoswitch	Get the state of automatic switching for audio source. Returns: @get /audio/autoswitch <state> Where: <state> = "on" or "off"
set /audio/autoswitch	Turn on or off automatic switching of audio source. Syntax: set /audio/autoswitch <state> Where: <state> = "on" or "off"
get /audio/defvolume	Get the default volume for input audio sources. Returns: @get /audio/defvolume <volume-level> Where: <volume-level> = 0..100 <i>NOTE: volume-level = 0 is mute</i>
set /audio/defvolume	Configure default volume for audio input sources. Syntax: set /audio/defvolume <volume-level> Where: <volume-level> = 0..100 <i>NOTE: volume-level = 0 is mute</i>
get /audio/gain/level	Get the gain level for the aux out audio. This level is only effective if the mode is set to "fixed". Returns: @get /audio/gain/level <level> Where: <level> = 0..100
set /audio/gain/level	Set the gain level for the aux out audio. This level is only effective if the mode is set to "fixed". Returns: @set /audio/gain/level <level> Where: <level> = 0..100
get /audio/gain/mode	Get the gain mode for the aux out audio. Returns: @get /audio/gain <mode> Where: <mode> = "var" or "fixed"

Serial Commands - ACV-2100 & ACV-5100 (Cont.)	
Command	Description
<code>set /audio/gain/mode</code>	Set the gain mode for the aux out audio. It can be set to follow the speaker volume ("var") or to a fixed value ("fixed"). Syntax: <code>set /audio/gain <mode></code> Where: <mode> = "var" or "fixed"
<code>get /audio/source</code>	Get the currently selected audio source. Returns: <code>@get /audio/source <setting></code> Where: <setting> = "aux", "bluetooth", "hdmi", "optical" or "usb"
<code>set /audio/source</code>	Set the audio output source. Syntax: <code>set /audio/source <setting></code> Where: <setting> = "aux", "bluetooth", "hdmi", "optical" or "usb"
<code>get /audio/state</code>	Get the state of the audio output (speakers & aux out). Returns: <code>@get /audio/state <state></code> Where: <state> = "normal" or "muted"
<code>set /audio/state</code>	Set the state of the audio output (speakers & aux out). Syntax: <code>set /audio/state <state></code> Where: <state> = "normal" or "muted"
<code>get /audio/volume</code>	Get the volume setting for the speaker audio. Returns: <code>@get /audio/volume <level></code> Where: <level> = 0..100
<code>set /audio/volume</code>	Set the volume for the speaker audio. Syntax: <code>set /audio/volume <level></code> Where: <level> = "+", "-", or 0..100 "+" and "-" increase and decrease, respectively, the volume in the same way as pressing the buttons on the control panel
<code>get /audmic/state</code>	Get the state of the microphone input. Returns: <code>@get /audmic/state <state></code> Where: <state> = "normal" or "muted"
<code>set /audmic/state</code>	Set the state of the microphone input. Syntax: <code>set /audmic/state <state></code> Where: <state> = "normal" or "muted"
<code>get /battery/state</code>	Get the state of the remote control's battery. Returns: <code>@get /battery/state <state></code> Where: <state> = "none", "low", "med" or "high"
<code>exec /bluetooth/pairing</code>	Initiate pairing or unpairing on the bluetooth. Syntax: <code>exec / bluetooth/pairing <action></code> Where: <action> = "pair" or "unpair"
<code>get /bluetooth/connstate</code>	Get the state of the Bluetooth connection. Returns: <code>@get /bluetooth/connstate <state></code> Where: <state> = "off", "on", "pairing", "paired" or "connected"
<code>get /bluetooth/state</code>	Get the state of the Bluetooth radio. Returns: <code>@get /bluetooth/state <state></code> Where: <state> = "on" or "off"
<code>set /bluetooth/state</code>	Set the state of the Bluetooth radio. Syntax: <code>set /bluetooth/state <state></code> Where: <state> = "on" or "off"

Serial Commands - ACV-2100 & ACV-5100 (Cont.)	
Command	Description
<code>get /camera/state</code>	Get the state of video streaming from the camera. Returns: <code>@get /camera/state <state></code> Where: <state> = "idle" or "streaming"
<code>exec /system/firmware/update</code>	Update firmware on the MCU. Will put the MCU into the bootloader, ready to load new firmware. Syntax: <code>exec /system/firmware/update</code>
<code>exec /system/firmware/update/bt</code>	Update firmware on the Bluetooth module. Will put the Bluetooth module into the bootloader, ready to load new firmware. Syntax: <code>exec /system/firmware/update/bt</code>
<code>get /system/model</code>	Get the system model. Returns: <code>@get /system/model <model></code> Where: <model> = "ACV-2100" or "ACV-5100"
<code>get /system/name</code>	Get the system device name. Returns: <code>@get /system/name <name></code> Where: <name> = device name string, maximum 30 characters
<code>set /system/name</code>	Set the device name to be used by the Bluetooth radio. Syntax: <code>set /system/name <name></code> Where: <name> = device name string, maximum 30 characters
<code>exec /system/reboot</code>	Execute a reboot on the MCU. Syntax: <code>exec /system/reboot</code>
<code>get /system/version</code>	Get the system firmware versions, as an ASCII string. Returns: <code>@get /system/firmware <fw_versions></code> Where: <fw_versions> = a string showing all of the firmware versions
<code>get /usbup/status</code>	Get the status of the external connector for USB upstream port. Returns: <code>@get /usbup/status <status></code> Where: <status> = "no connection", "connected"

Serial Commands - ACV-5100 ONLY

The following table includes commands that apply only to the ACV-5100.

Commands in *italics> may be generated by the commissioning tool. However, they may also be entered on any of the command interfaces.*

Serial Commands - ACV-5100 ONLY	
Command	Description
<code>set /display/state</code>	Turn off or turn on and switch to Acendo Vibe the display connected to the HDMI output. Syntax: <code>set /display/state <state></code> Where: <state> = "off" or "on"
<code>get /occupancy/sensitivity</code>	Get the occupancy detection sensitivity. Returns: <code>@get /occupancy/sensitivity <threshold></code> Where: <threshold> = "off", "low", "medium" or "high"
<code>set /occupancy/sensitivity</code>	Set the sensitivity for occupancy detection. Syntax: <code>set /occupancy/sensitivity <threshold></code> Where: <threshold> = "off", "low", "medium" or "high"
<code>get /occupancy/external/state</code>	Get the state of external occupancy sensor (future firmware upgrade). Returns: <code>@get /occupancy/external/state <state></code> Where: <state> = "none", "occupied" or "vacant"

Serial Commands - ACV-5100 (Cont.)	
Command	Description
<code>get /occupancy/internal/state</code>	Get the state of the internal occupancy sensor (mic's). Returns: @get /occupancy/internal/state <state> Where: <state> = "none", "occupied" or "vacant"
<code>set /ringleds/color</code>	Set the color of the ring (meeting status) LEDs. Syntax: set /ringleds/color <color> Where: <color> = R:G:B where R, G, and B are 0..255. Note: R=G=B=0 turns LEDs off
<code>set /ringleds/state</code>	Set the state of the ring (meeting status) LEDs. Syntax: set /ringleds/state <state> Where: <state> = "off", "on" or "pulsing"
<code>get /trigger/hdmiconn/action</code>	Get display action for the HDMI connect trigger event. Returns: @get /trigger/hdmiconn/action <display-action> Where: <display-action> = "none" or "on"
<code>set /trigger/hdmiconn/action</code>	Configure display action for the HDMI connect trigger event. Syntax: set /trigger/hdmiconn/action <display-action> Where: <display-action> = "none" or "on"
<code>get /trigger/hdmiconn/delay</code>	Get delay time for the HDMI connect trigger event. Returns: @get /trigger/hdmiconn/delay <delay> Where: <delay> = 0..300 (seconds)
<code>set /trigger/hdmiconn/delay</code>	Configure delay time for the HDMI connect trigger event. Syntax: set /trigger/hdmiconn/delay <delay> Where: <delay> = 0..300 (seconds)
<code>get /trigger/hdmidis/action</code>	Get display action for the HDMI disconnect trigger event. Returns: @get /trigger/hdmidis/action <display-action> Where: <display-action> = "none" or "off"
<code>set /trigger/hdmidis/action</code>	Configure display action for the HDMI disconnect trigger event. Syntax: set /trigger/hdmidis/action <display-action> Where: <display-action> = "none" or "off"
<code>get /trigger/hdmidis/delay</code>	Get delay time for the HDMI disconnect trigger event. Returns: @get /trigger/hdmidis/delay <delay> Where: <delay> = 0..300 (seconds)
<code>set /trigger/hdmidis/delay</code>	Configure delay time for the HDMI disconnect trigger event. Syntax: set /trigger/hdmidis/delay <delay> Where: <delay> = 0..300 (seconds)
<code>get /trigger/occupancy/action</code>	Get display action for the occupancy detect trigger event. Returns: @get /trigger/occupancy/action <display-action> Where: <display-action> = "none" or "on"
<code>set /trigger/occupancy/action</code>	Configure display action for the occupancy detect trigger event. Syntax: set /trigger/occupancy/action <display-action> Where: <display-action> = "none" or "on"
<code>get /trigger/occupancy/delay</code>	Get delay time for the occupancy detect trigger event. Returns: @get /trigger/occupancy/delay <delay> Where: <delay> = 0..300 (seconds)

Serial Commands - ACV-5100 (Cont.)	
Command	Description
set /trigger/occupancy/delay	Configure delay time for the occupancy detect trigger event. Syntax: set /trigger/occupancy/delay <delay> Where: <delay> = 0..300 (seconds)
get /trigger/vacancy/action	Get display action for the vacancy detect trigger event. Returns: @get /trigger/vacancy/action <display-action> Where: <display-action> = "none" or "off"
set /trigger/vacancy/action	Configure display action for the vacancy detect trigger event. Syntax: set /trigger/vacancy/action <display-action> Where: <display-action> = "none" or "off"
get /trigger/vacancy/delay	Get delay time for the vacancy detect trigger event. Returns: @get /trigger/vacancy/delay <delay> Where: <delay> = 0..300 (seconds)
set /trigger/vacancy/delay	Configure delay time for the vacancy detect trigger event. Syntax: set /trigger/vacancy/delay <delay> Where: <delay> = 0..300 (seconds)
get /video/cec	Get the state of CEC control on HDMI out. Returns: @get /video/cec <state> Where: <state> = "off" or "on"
set /video/cec	Disable or enable use of CEC on HDMI out. Syntax: set /video/cec <state> Where: <state> = "off" or "on"
get /video/status	Get the status of the external connector for HDMI input. Returns: @get /video/status <status> Where: <status> = "none", "connected"

Events

Acendo Vibe will send event messages when asynchronous events, i.e. occurrences not related to a received command, happen.

Note that the Acendo Vibe supports the Command Protocol on both its USB and RS-232 interfaces. However, events are only reported on the RS-232 interface.

The table below shows the possible events to be reported with the EVENT message:

Event <Event Name> <Event Data>

Event Name	Event Data	Description
boot_complete		Booting complete
bt_conn		Bluetooth connected
bt_dis		Bluetooth disconnected
bt_remote_conn		Remote control connected
bt_remote_dis		Remote control disconnected
bt_inactive		Bluetooth audio inactive for 30 minutes
bt_oor		Bluetooth out-of-range for 5 minutes
hdmi_conn		Connection on external HDMI input
hdmi_dis		Disconnection on external HDMI input
mic_mute		Microphone muted
mic_unmute		Microphone unmuted
occupancy_det		Occupancy detected
spkr_mute		Speakers muted
spkr_unmute		Speakers unmuted
src_change_audio	<setting> = "aux", "bluetooth", "hdmi", "optical" or "usb"	Audio source changed
usb_conn		Connection on external USB
usb_dis		Disconnect on external USB
vacancy_det		No occupancy detected for N seconds
vol_change	<level> = 0..100	Volume changed

Troubleshooting

Problem: USB Connection Lost (FIG. 53):



FIG. 53 Remote control - bottom panel (lock/unlock/remove)

Possible Solution:

The USB connection has come loose on either the Acendo Vibe unit, or on the connected laptop/PC. Check the USB connections and make sure they are fully seated and secure in the USB port(s).

Problem: Acendo Vibe Not Recognized as an audio device when connected to a laptop/PC via USB

When the Acendo Vibe is connected to a Windows laptop/PC, it should be auto-selected as the default audio device for both speakers and microphone. If the Acendo Vibe is not auto-selected, then it must be manually set as the default audio device.

Possible Solution:

1. With the Acendo Vibe connected via USB, open Windows Control Panel.
2. Select Sound.
3. Set the Acendo Vibe as the default speaker device:
 - a. In the Playback tab, select "USB Audio Codec".
 - b. Click on Set Default.
4. Set the Acendo Vibe as the default microphone device:
 - a. In the Recording tab, select "AMX Acendo Vibe".
 - b. Click on Set Default.
5. Unplug and re-connect the Acendo Vibe USB connection.

Problem: Sound from digital audio source device not coming out of speakers

Possible Solution:

The Acendo Vibe's speaker amplifier supports digital audio inputs (mono or stereo) of 44.1 kHz and 48 kHz sample rates, at bit depths of 16, 20 and 24. Digital audio from USB, Optical, and HDMI inputs not at these sample rates and bit depths will not be heard on the Acendo Vibe speakers. However, the audio may be available via the Acendo Vibe's Aux Out or HDMI outputs.

Problem: Remote Control doesn't work

Possible Solutions:

- Verify that the Remote Control is paired to the Acendo Vibe via Bluetooth - see the *Pairing the Remote Control to the Acendo Vibe* section on page 14.
 - Replace the batteries in the Remote Control:
1. Remove the bottom panel of the remote control to access the battery compartment:
 2. On the bottom panel, flip the plastic lock to the Unlocked position (FIG. 54):

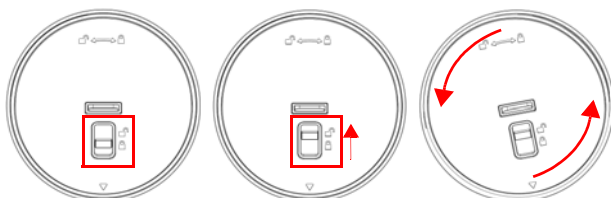

FIG. 54 Remote control - bottom panel (lock/unlock/remove)

3. Rotate the bottom panel to the left and lift to remove.
4. Replace the two AA batteries and dispose the old batteries properly.
5. Replace and lock the bottom panel.



© 2018 Harman. All rights reserved. Metreau, NetLinx, AMX, AV FOR AN IT WORLD, HARMAN, and their respective logos are registered trademarks of HARMAN. Oracle, Java and any other company or brand name referenced may be trademarks/registered trademarks of their respective companies. AMX does not assume responsibility for errors or omissions. AMX also reserves the right to alter specifications without prior notice at any time. The AMX Warranty and Return Policy and related documents can be viewed/downloaded at www.amx.com.

LAST REVISED:
2/20/2018

3000 RESEARCH DRIVE, RICHARDSON, TX 75082 AMX.com | 800.222.0193 | 469.624.8000 | +1.469.624.7400 | fax 469.624.7153
AMX (UK) LTD, AMX by HARMAN - Unit C, Auster Road, Clifton Moor, York, YO30 4GD United Kingdom • +44 1904-343-100 • www.amx.com/eu/