

Crestron® 8-Channel Commercial Amplifiers

The Crestron® [AMP-8075](#), [AMP-8150](#), [AMPI-8075](#), and [AMPI-8150](#) are high-efficiency multichannel power amplifiers offering excellent sound quality. All four feature similar operation. For simplicity within this guide, the term "amplifier" is used for all models except where noted.



In the Box

- 1 AMP-8075, AMP-8150, AMPI-8075, or AMPI-8150, 8-Channel Commercial Amplifier

Additional Items

- 2 Bracket, Rack Ear, 1U (2032122)
- 2 Bracket, Rear Mounting (2045677)
- 8 Connector, 2-Pin (2044402)
- 8 Connector, 3-Pin (2003575)

AMP-8075 and AMP-8150 Only

- 1 Fuse, 10.0 A, Time Lag, 1.25 in. x 0.25 in., Ceramic Cartridge, 250 V (2017577)
- 1 Cable, Power, 6 ft 7 in. (2001134)

AMPI-8075 and AMPI-8150 Only

- 1 Fuse, 6.3 A, Time Lag, 5 x 20 mm, Ceramic Cartridge, 250 V (2024846)
- 1 Cable, Power (P/N varies by country)



Install the Device

These devices occupy 1U of rack space.

To install the included rack ears:

1. Use a #1 Phillips screwdriver to remove the three screws from each side of the front of the amplifier as shown in the following illustration.
2. Use the six screws removed in the previous step to attach the included rack ears to the amplifier.

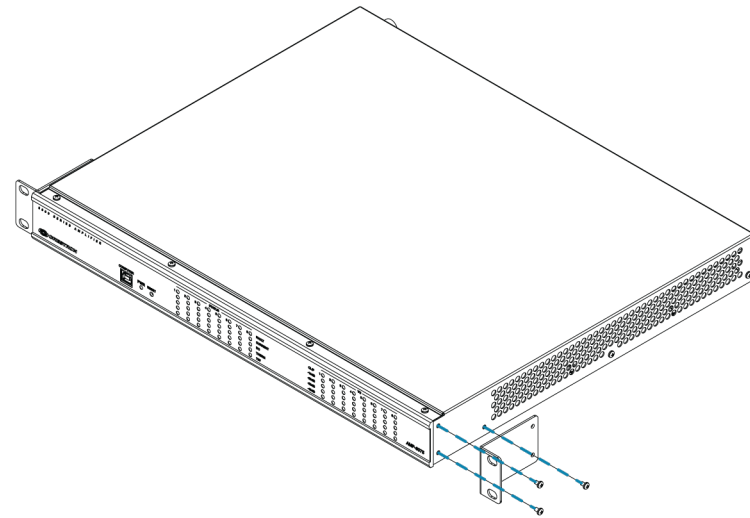

Crestron® 8-Channel Commercial Amplifiers

To install the included rear mounting brackets:

1. Use a #1 Phillips screwdriver to remove the four screws from the rear of the amplifier as shown in the following illustration.
2. Use the four screws removed in the previous step to attach the mounting brackets to the rear of the amplifier.

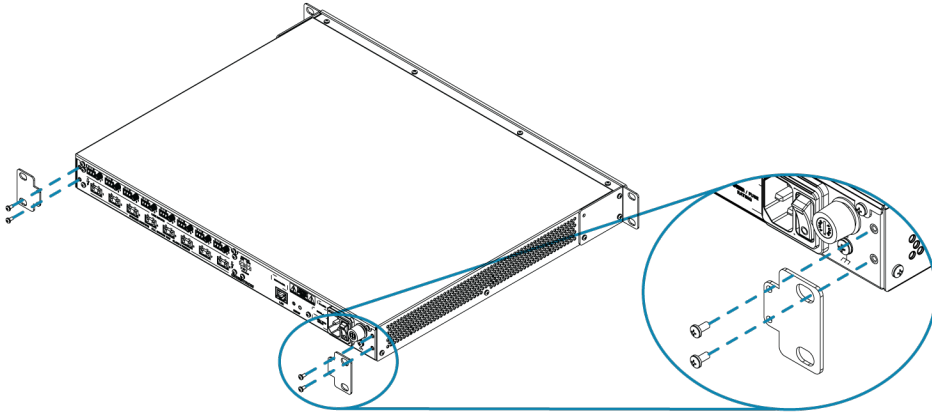

Then mount the device into the rack using four rack mounting screws (not included).



Connect the Device

Connect the device as called out in the following illustrations. Connect power last.

CAUTIONS:

- Keep the device unplugged until all of the input, network, and speaker wiring is complete.
- Check the speaker cables for shorts and frayed wiring around the SPEAKER OUTPUTS connectors.

NOTES:

- Ensure the unit is properly grounded by connecting the chassis ground lug to an earth ground (building steel).
- To prevent overheating, do not operate this product in an area that exceeds the environmental temperature range listed in the table of specifications on the product web page. Fans provide side-to-side airflow for cooling. Do not block the ventilation holes.

Crestron® 8-Channel Commercial Amplifiers

Amplifier Front

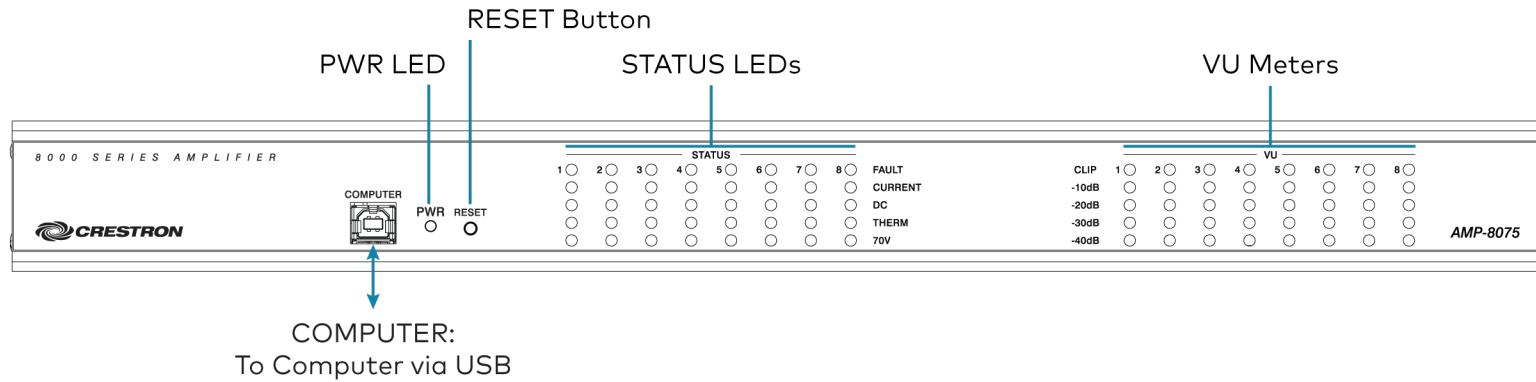

Amplifier Rear

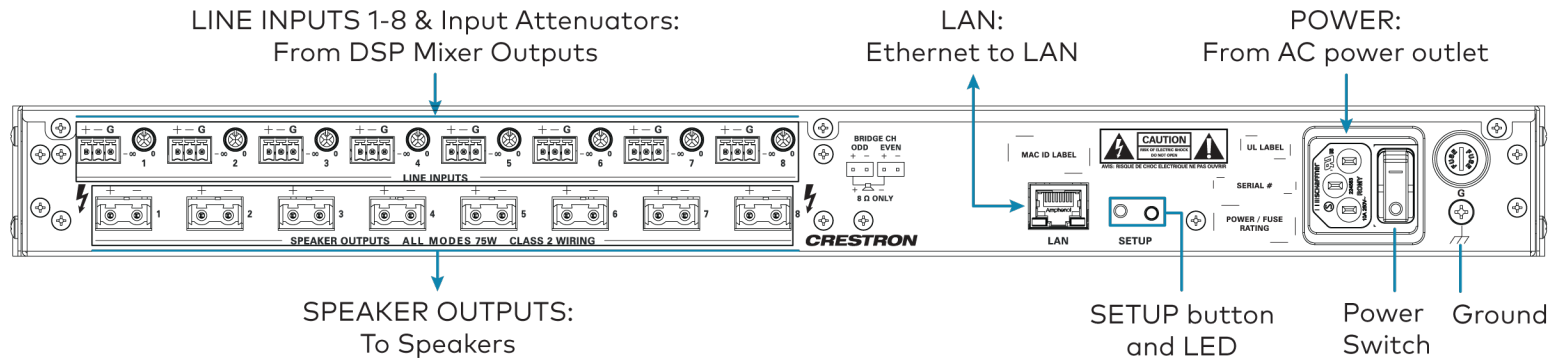

Crestron® 8-Channel Commercial Amplifiers

Line Input Connection

If an unbalanced connection from a line input is required, use a jumper between the negative (-) and ground (G) terminals.

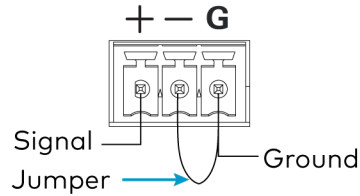

Speaker Connections

The speaker outputs can be wired conventionally or they can be bridged to deliver higher power. Refer to the following illustrations when connecting speakers.

WARNING: This amplifier is capable of delivering high power to the loudspeakers. Please use caution and wear adequate hearing protection if listening at high volume, as continued exposure to high sound pressure levels can cause permanent hearing impairment or loss.

Conventional Wiring

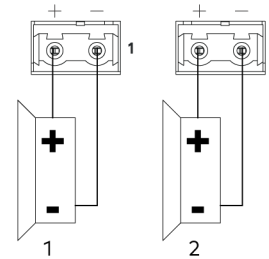

Bridged Wiring

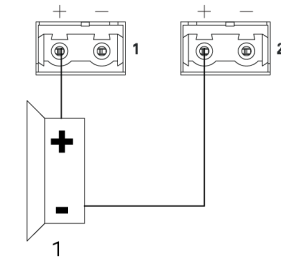

Speakers are bridged with the Crestron Avia™ Audio tool, which can be downloaded from www.crestron.com/software. The possible bridging combinations are Output 1 & Output 2, Output 3 & Output 4, Output 5 & Output 6, and Output 7 & Output 8.

NOTE: The minimum load impedance for bridged channels is 8 ohms.

Crestron® 8-Channel Commercial Amplifiers

Fuse Replacement

if the amplifier does not power up when power is turned on, the fuse may need to be replaced. The fuse holder is located on the rear panel next to the power switch. To replace the fuse:

1. Disconnect power to the amplifier.
2. Use a flat-head screwdriver to push in the fuse holder.
3. While pushing in the fuse holder, turn the screwdriver counterclockwise until the fuse holder pops out.
4. Remove the fuse from the fuse holder and insert a new fuse.

Models	Required Fuse Type
AMP-8075 AMP-8150 (US & Canada)	10.0 A, Time Lag, 1.25 in. x 0.25 in., Ceramic Cartridge, 250 V
AMPI-8075 AMPI-8150 (International/220-240 VAC)	6.3 A, Time Lag, 5 x 20 mm, Ceramic Cartridge, 250 V

CAUTION: Use the specified type of fuse only. Failure to do so may cause damage to the amplifier.

NOTE: One spare fuse is included with the amplifier.

5. Insert the fuse holder into the amplifier.
6. Push in the fuse holder with a flat-head screwdriver.
7. While pushing in the fuse holder, turn the screwdriver clockwise until the fuse holder locks in place.
8. Connect power to the amplifier.



Operate the Device

Apply Power

To turn the amplifier on, move the power switch (located next to the power connector) to **I**. To turn the amplifier off, move the power switch to **O**. This will also reset the device.

When power is applied to the device, the PWR LED on the front panel operates with the following behavior:

- Green - Normal operation
- Amber - Device is booting up
- Amber/Green (cycling) - No network connection

Adjust the Signal Levels

Each channel has an input attenuator on the rear panel. Use these to adjust the loudness in each zone. To adjust the level of an input, turn the knob clockwise to increase the signal level, or counterclockwise to reduce the signal level.

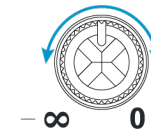

Crestron® 8-Channel Commercial Amplifiers

Monitor Operation

Use the status indicators and VU meters on the front panel to monitor each speaker output.

LEDs in the STATUS section indicate the following for each output:

- Presence of a fault
- An overcurrent condition
- A DC offset condition
- Excessive operating temperature
- 70 volt operation (100 volt operation for the AMPI-8075 and AMPI-8150)

LEDs in the VU section indicate the signal level of each output and whether a clipping condition is present.

Reset the Device

Press **RESET** on the front panel to restart the device.



Connect to Crestron XiO Cloud Service (Optional)

The Crestron XiO Cloud™ service allows supported Crestron devices across an enterprise to be managed and configured from one central and secure location in the cloud. Supported devices are preconfigured to connect to the service. Use of the service requires a registered Crestron XiO Cloud account.

NOTE: The device can be disconnected from the service using the **Cloud Services** tab in Crestron Toolbox™ software (**Functions > Device Info > Cloud Services**). For details, refer to the Crestron Toolbox help file.

To connect the device to the Crestron XiO Cloud service:

1. Record the MAC address and serial number labeled on the shipping box or rear panel of the device. The MAC address and serial number are required in order to add the device to the Crestron XiO Cloud environment.
2. Do either of the following:
 - Access the Crestron XiO Cloud service at <https://portal.crestron.io>.
 - Register for a Crestron XiO Cloud account at www.crestron.com/xiocloud.

For detailed information about using the Crestron XiO Cloud service, refer to the Crestron XiO Cloud Service User Guide (Doc. 8214) at www.crestron.com/manuals.

Crestron® 8-Channel Commercial Amplifiers



Visit the Product Page

Scan the QR code to visit the product page.

AMP-8075



www.crestron.com/model/6507619

AMP-8150



www.crestron.com/model/6507608

AMPI-8075



www.crestron.com/model/6507874

AMPI-8150



www.crestron.com/model/6507875

Additional Information

For information on RoHS declarations for the AMP-8075 and AMP-8150, refer to the [AMP-8075 and AMP-8150 Notice](#) (Doc. 8759).

Original Instructions

The U.S. English version of this document is the original instructions. All other languages are a translation of the original instructions.

Crestron product development software is licensed to Crestron dealers and Crestron Service Providers (CSPs) under a limited nonexclusive, nontransferable Software Development Tools License Agreement. Crestron product operating system software is licensed to Crestron dealers, CSPs, and end-users under a separate End-User License Agreement. Both of these Agreements can be found on the Crestron website at www.crestron.com/legal/software_license_agreement.

The product warranty can be found at www.crestron.com/warranty.

The specific patents that cover Crestron products are listed at www.crestron.com/legal/patents.

Certain Crestron products contain open source software. For specific information, visit www.crestron.com/opensource.

Crestron, the Crestron logo, Crestron Avia, Crestron Toolbox, and Crestron XiO Cloud are either trademarks or registered trademarks of Crestron Electronics, Inc. in the United States and/or other countries. Other trademarks, registered trademarks, and trade names may be used in this document to refer to either the entities claiming the marks and names or their products. Crestron disclaims any proprietary interest in the marks and names of others. Crestron is not responsible for errors in typography or photography.

©2020 Crestron Electronics, Inc.

Doc. 7813H

05/22/20