



CBT 1000

Constant Beamwidth Technology™ High-Output Two-Way Line Array Column with Adjustable Vertical Coverage & Tapered Horizontal Waveguide

CBT SERIES

CONSTANT BEAMWIDTH TECHNOLOGY™

Key Features:

- ▶ Vertical pattern coverage individually adjustable with four (4) “Pattern Up” coverage angles and four (4) “Pattern Down” coverage angles for a total of sixteen (16) different coverage combinations, all without the use of external DSP processing.
- ▶ Asymmetrical vertical settings send more sound toward far area of room to make front-to-back sound levels more consistent.
- ▶ Components:
 - Twenty-four (24) 25 mm (1 in) extra-high-power soft dome tweeters.
 - Six (6) 165 mm (6-1/2 in) high-excursion LF drivers arranged coaxially.
- ▶ Very high sound levels up to 131 dB (137 dB peaks), depending on the settings.
- ▶ Constant Beamwidth Technology™ provides constant directivity coverage and reduces out of coverage lobing.
- ▶ Patent-pending Tapered Horizontal Waveguide provides a continuously varying horizontal dispersion (very wide for short-throw, narrower for long-throw) delivering superior coverage in both the front and rear corners of a room and reducing over-splash.
- ▶ Wide 45 Hz - 20 kHz frequency response.
- ▶ Switchable voicing provides flat response in music mode or mid-range presence peak in speech mode.
- ▶ Swivel (pan)/tilt wall bracket included.

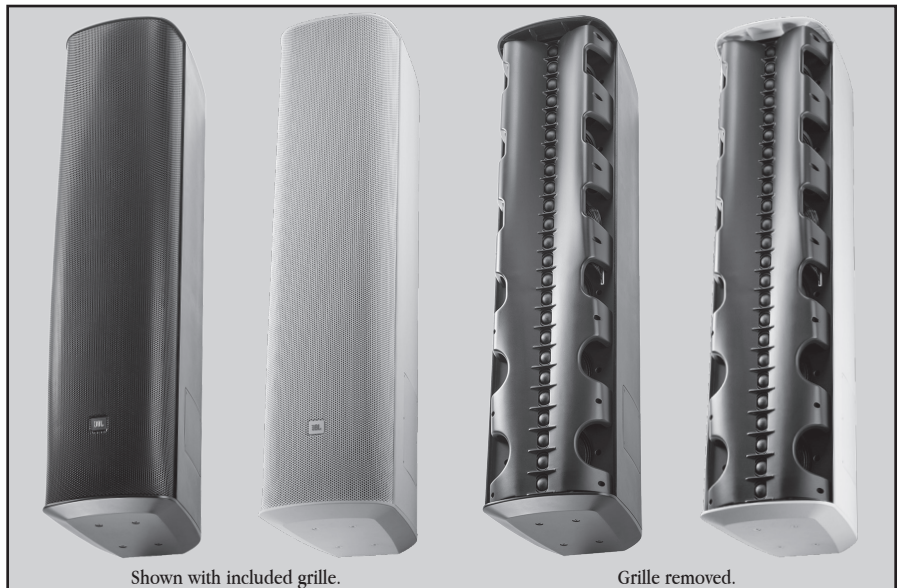

Overview:

The CBT 1000 represents the next-generation in pattern control, expanding upon JBL’s highly successful CBT Constant Beamwidth Technology™ products. Utilizing patented complex analog beam-forming, the CBT 1000 provides superior and consistent vertical coverage without the narrow vertical beaming and out-of-coverage lobing that are typical of straight form-factor column speakers.

The CBT 1000 combines Constant Beamwidth Technology with adjustable vertical coverage and a tapered horizontal waveguide to increase the versatility of aiming the coverage of the loudspeaker to more accurately map to the room geometry in a wide variety of listening spaces. The asymmetrical coverage settings produce a higher concentration of sound with a tighter pattern from the upper half of the array, and a lower concentration of sound with a broader vertical pattern from the lower half of the array. This sends more sound toward the far area of the room than to the near area of the room, resulting in more even front-to-back SPL levels than would be the case from a traditional speaker or column that projects symmetrically in the vertical plane. Additionally, the vertical coverage pattern is individually installer adjustable through a range of four “Pattern Up” coverage angles and four “Pattern Down” coverage angles for a total of sixteen different coverage combinations, all without the use of any external DSP processing. The new patent-pending Tapered Horizontal Waveguide design provides a continuously varying horizontal dispersion by providing a very wide angle of dispersion for the short-throw distances while also providing a narrower horizontal angle of dispersion for the long-throw distances, providing superior coverage in both the front and rear corners of a room. The consistent pattern control allows the CBT 1000 to work well in difficult acoustic environments.

The two-way coaxial design provides a wide 45 Hz – 20 kHz bandwidth. The low-diffraction baffle eliminates frequency response irregularities that could otherwise occur due to baffle discontinuities. The thick, heavy-duty aluminum grille allows for rust-free installation outdoors. At 102 cm (40.2 in) tall and only 25 cm (9.9 in) wide, the design fits well with virtually any architectural décor.

CBT 1000 Two-Way Line Array Column with Adjustable Vertical Coverage and Tapered Horizontal Waveguide

Applications

Combining superior sound quality, excellent pattern control, asymmetrical vertical coverage, continuously variable horizontal dispersion, and compact design makes the CBT 1000 extremely versatile. It is ideal for applications such as performance auditoriums, houses of worship, lecture halls, classrooms, cinema main speakers or very high-output surrounds, multipurpose spaces, A/V, transit centers, sports facilities, racetracks, theme parks, outdoor locations, and high-level fill applications, among many others.

Adjustable Coverage to Fit the Application

Vertical pattern coverage settings are set via easy-to-configure headers located in a covered compartment on the side of the speaker. The innovative adjustability allows the installer to switch through a range of four (4) "Pattern Up" coverage angles and four (4) "Pattern Down" coverage angles for a total of sixteen (16) different coverage combinations. Additionally, the use of a patent-pending Tapered Horizontal Waveguide provides a continuously varying horizontal dispersion (very wide for short-throw, narrower for mid-throw, even more narrow for long-throw) delivering superior coverage in both the front and rear corners of a room while reducing undesirable over-splash. These unique features allow the user to more closely match the coverage and throw requirements to the application, and the coverage selection can be easily switched in-venue with the speaker already installed. These innovations allow a single loudspeaker model to excel in an extremely wide variety of project types.

User Variable Voicing

The voicing can be set to match the application through a Music/Speech switch. The Music setting provides flat frequency response, while the Speech setting produces a mid-range presence boost to provide clear, intelligible speech even at the longest throw distances, along with increased midrange sensitivities for higher midrange maximum output capability.

Drivers

The low frequency drivers feature lightweight neodymium motors with 50 mm (2.0 in) diameter voice coils. The magnet system provides maximum flux in a compact package. The magnet structure is magnetically shielded and the drivers have a copper cap on the pole to minimize flux modulation and linearize inductance, resulting in lower distortion and improved frequency response. The 16 mm (0.63 in) long coil provides high linear drive and high power handling in a compact driver. The LF drivers feature damped blended textile surrounds and coated sealed paper cones found in high performance large format drivers.

The high frequency drivers include neodymium structure for maximum sensitivity, and feature high power handling, long excursion and large back enclosures for additional frequency range and output. The tweeter is encased for weather resistance.

Both drivers feature coated diaphragm materials to provide moisture, UV and salt resistance for outdoor capability.

SonicGuard™

Dynamic SonicGuard™ protection on the high frequency section minimizes distortion at high drive levels by limiting driver excursion dynamically. This maximizes music clarity and speech intelligibility at high drive levels while protecting the drivers from damage due to occasional overpowering.

Bracketry & Insert Points

A two-part swivel (pan) / tilt wall-mount bracket is included. Fourteen (14) M8 brass inserts are located on the back panel in a spacing pattern that fits common third-party mounting brackets. In addition, four insert points each are located on the top and bottom end-caps. These insert points can be utilized to suspend the speaker using forged shoulder steel eyebolts or swivel mounting rings, providing installation versatility. Optional brackets include MTC-CBT-FM3 (in MTC-CBT1K-ACC1 kit) for flush-mounting the back of the speaker to a wall, and MTC-CBT-SUS3 CBT Series suspension bracket kit.

Outdoor Capability

CBT 1000 can be installed either indoors or outdoors. The drivers are weather-treated, the fiberglass reinforced ABS cabinet is excellent for outdoor applications, and the paint is UV resistant. External screws are stainless steel and the powder coated 1050 aluminum grille resists rust in the harshest of conditions. The optional MTC-PC2 panel cover with gland nut seals the terminal compartment from excessive moisture.

Color

Available in black (RAL9004) or White (-WH) (RAL9016).

CBT 1000 Two-Way Line Array Column with Adjustable Vertical Coverage and Tapered Horizontal Waveguide

Specifications:

System:

Components: Six (6) 165 mm (6.5 in) LF drivers
Twenty-four (24) 25 mm (1 in) HF drivers

Frequency Range (-10 dB)¹: 45 Hz – 20 kHz

Sensitivity (2.83V@ 1m)^{1,2}: 102 dB (at highest sensitivity setting: “Point” pattern up, “Point” pattern down, “Speech” voicing, in free space)
95 dB (at lowest sensitivity setting: “Medium” pattern up, “Downfill” pattern down, “Music” voicing in free space)

Nominal Impedance: 4 ohms (4 ohms above 1 kHz; 8 ohms below 800 Hz)

Power Capacity³: 1500 W (6000 W peak), 2 hrs
1000 W (4000 W peak), 100 hrs

Maximum Input Voltage: 65.0 Volts RMS (2 hrs), 130.0 Volts Peak

Max SPL⁴: Highest directivity setting: (“Point” pattern up, “Point” pattern down) with “Speech” voicing:
131 dB continuous average pink noise
134 dB continuous program
137 dB Peak

Highest directivity setting: (“Point” pattern up, “Point” pattern down) with “Music” voicing:
127 dB continuous average pink noise
130 dB continuous program
133 dB peak

Lowest directivity setting: (“Medium” pattern up, “Downfill” pattern down) with “Speech” voicing:
128 dB continuous average pink noise
131 dB continuous program
134 dB peak

Lowest directivity setting: (“Medium” pattern up, “Downfill” pattern down) with “Music” voicing:
124 dB continuous average pink noise
127 dB continuous program
130 dB peak

Vertical Coverage Settings: Coverage is effective (frequency response similar) beyond the traditional -6 dB coverage angles. This is especially useful in compensating for differences in listening distances. Figures show both the -6 dB and -12 dB coverage angles (at 3 kHz). Angles are in reference to cabinet aiming axis.

Pattern UP Settings:

“Point”: -6dB @ +7°, -12 dB @ +12°
“Tight”: -6dB @ +9°, -12 dB @ +15°
“Narrow”: -6dB @ +10°, -12 dB @ +20°
“Medium”: -6dB @ +13°, -12 dB @ +24°

Pattern DOWN Settings:

“Point”: -6dB @ -7°, -12 dB @ -12°
“Narrow”: -6dB @ -10°, -12 dB @ -20°
“Broad”: -6dB @ -17°, -12 dB @ -28°
“Downfill”: -6dB @ -20°, -12 dB @ -35°

Horizontal Coverage: Patent-pending Tapered Horizontal Waveguide continuously variable.

Long-throw (top) section: 100°
Middle section: 130°
Short-throw (bottom) section: 160°

Recommended High-Pass: 35Hz, 24 dB/oct or greater

Transducers:

Low Frequency Drivers: 6 pcs, 165 mm (6.5 in) drivers, lightweight neodymium motors, 50 mm (2.0 in) diameter voice coils, copper-capped pole tips to minimize flux modulation and linearize inductance, 16 mm (0.63 in) long coil for high linear drive and high power handling, damped blended textile surround, coated cones for moisture, UV and salt resistance. Magnetically shielded.

High Frequency Drivers: 24 pcs, 25 mm (1 in) drivers, neodymium, encased magnet and coated diaphragm for moisture, UV, and salt resistance.

CBT 1000 Two-Way Line Array Column with Adjustable Vertical Coverage and Tapered Horizontal Waveguide

Enclosure:

Enclosure:	Fiberglass reinforced ABS cabinet, powder coated 1050 aluminum grille
Outdoor Capability:	IP-55 rated, per IEC529, when installed with optional MTC-PC2 cover. Exceeds Mil Spec 810 for humidity, temperature & UV, ASTM G85 for acid-air/salt-spray (200 hrs).
Colors:	Black (RAL9004) or White (-WH) (RAL9016)
Insert Points:	14 individual M8 inserts on back panel (20 mm deep) for use with swivel (pan)/tilt bracket(s), forged-shoulder steel eyebolts, swivel rings, and after-market third-party brackets, plus 4 individual M8 inserts on top and 4 on bottom of cabinet end-caps.
Mounting:	Included two-part swivel (pan)/tilt wall bracket provides continuously variable +/- 45 degree left-right swivel aiming (at no up/down tilt – see Bracket Guide for maximum swivel range at various up/down tilt angles), +/- 15 degree tilt in 1 degree fixed increment points. Fourteen (14) threaded mounting points located on back panel of cabinet conform to industry standard rectangular 127 x 70 mm (5.0 x 2.75 in) pattern for legacy OmniMount® and other compatible third-party brackets. Four (4) threaded mount points on the top end-cap and four (4) on the bottom end-cap. Threaded mounting points can be utilized for suspension. (Always use multiple mounting points.)
Dimensions (H x W x D):	1020 mm x 250 mm x 345 mm (40.2 x 9.9 x 13.6 in)
Net Weight (cabinet):	24.5 kg (54 lbs)
Shipping Weight:	38.6 kg (85 lbs)
Included Accessories:	Two-piece swivel (pan)/tilt wall bracket
Optional Accessories:	MTC-PC2 terminal panel cover CBT1K-ACC1 Accessory kit includes: 2 pcs MTC-CBT-FM3 flush-mount brackets 1 pc MTC-CBT-OS3 offset bracket (for CBT 1000+1000E array – works in conjunction with CBT 1000E's included Coupler Plate for locating CBT 1000E extension cabinet above CBT 1000 instead of below it) MTC-CBT-SUS3 CBT Series suspension bracket kit (2 pcs included to provide top and bottom attachment points)

¹Full space

²2.85V @ 1 meter, averaged 2 kHz to 6 kHz; same sensitivity in this range for CBT 1000 alone and CBT 1000+CBT 1000E (for more information see notes in FAQ); Subtract 3 dB for 2.00V @ 1 meter sensitivity.)

³IEC standard, full bandwidth pink noise with 6 dB crest factor.

⁴2 kHz - 6 kHz, calculated based on power rating and measured sensitivity, exclusive of power compression.

JBL continually engages in research related to product improvement.

Changes introduced into existing products without notice are an expression of that philosophy.

CBT 1000 Two-Way Line Array Column with Adjustable Vertical Coverage and Tapered Horizontal Waveguide

Array's Upper-Half Coverage Pattern Selections

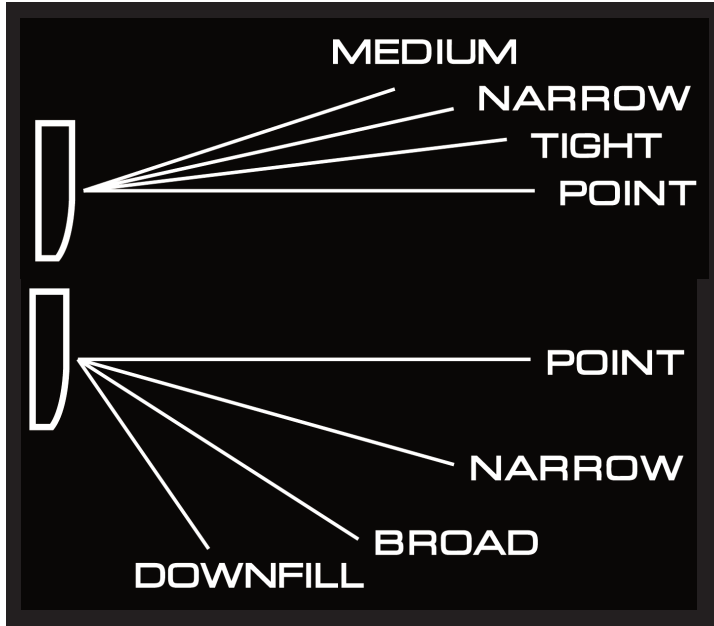

Array's Lower-Half Coverage Pattern Selections

Coverage Pattern Selection Panel

Located on side of cabinet; covered by plate. Must remove screws using #1 Phillips head screwdriver, not included.

Position the orange headers to select the coverage patterns and Music/Speech voicing.

(Header positions shown below: Array Upper Half **NARROW** pattern setting, Array Lower Half **DOWNFILL** pattern setting, and **MUSIC/FLAT EQ** [Voicing] setting.)

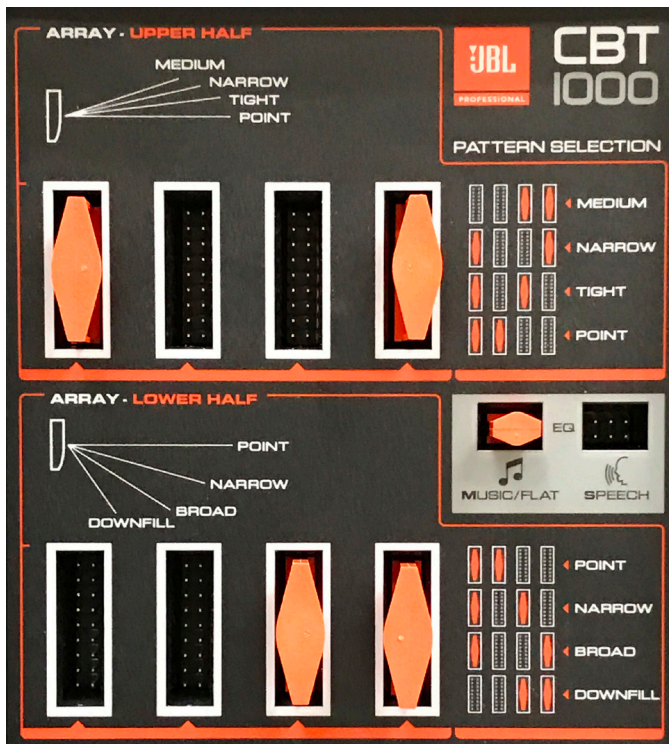

CBT 1000 Two-Way Line Array Column with Adjustable Vertical Coverage and Tapered Horizontal Waveguide

Pattern: Up “Medium”; Down “Downfill”
(widest vertical setting; asymmetrical)

Frequency Response & Impedance:
Sensitivity 2.83V @ 1m, and Impedance
“Music” mode (solid) “Speech” Mode (dotted)

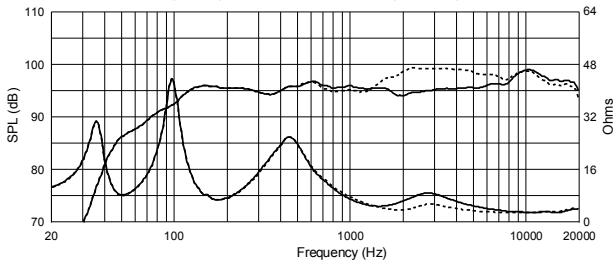

Beamwidth:

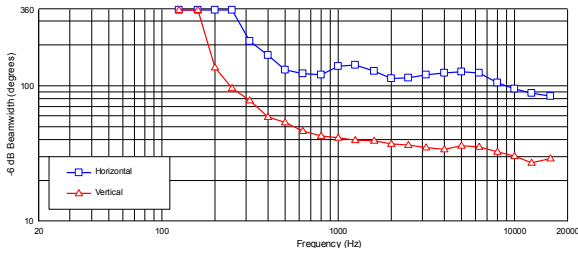

Vertical Off-Axis Frequency Response, Up:

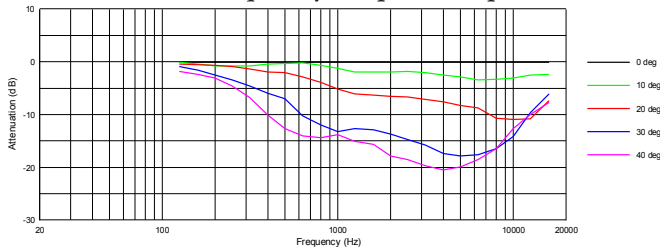

Vertical Off-Axis Frequency Response, Down:

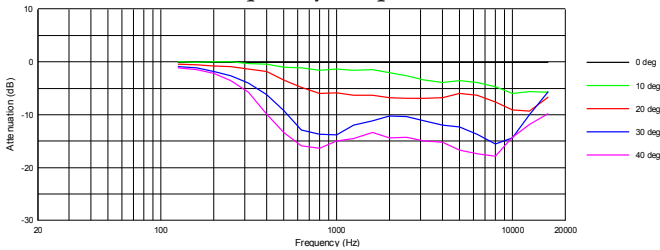

Horizontal Off-Axis Frequency Response:

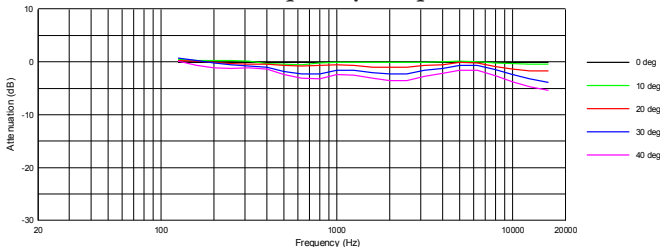

Pattern: Up “Narrow”; Down “Broad”
(medium vertical setting; asymmetrical)

Frequency Response & Impedance:
Sensitivity 2.83V @ 1m, and Impedance
“Music” mode (solid) “Speech” Mode (dotted)

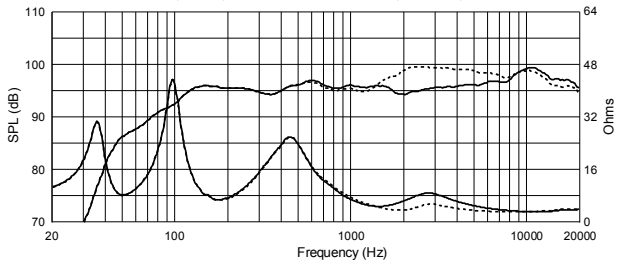

Beamwidth:

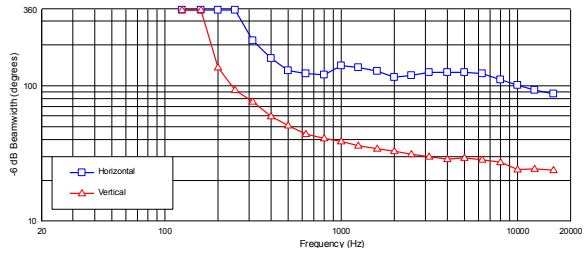

Vertical Off-Axis Frequency Response, Up:

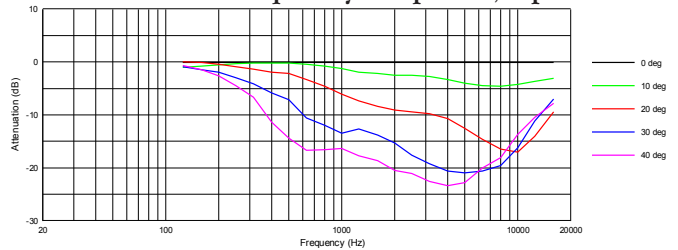

Vertical Off-Axis Frequency Response, Down:

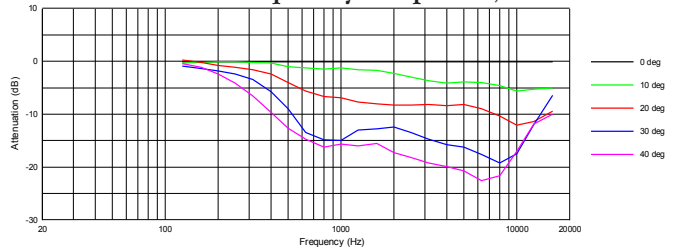

Horizontal Off-Axis Frequency Response:

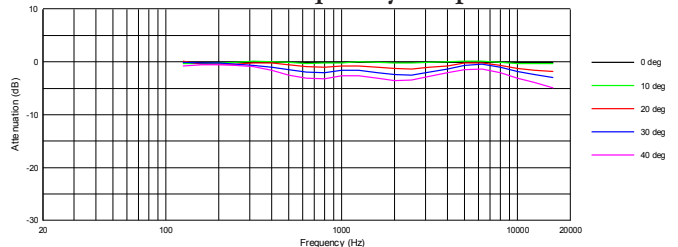

CBT 1000 Two-Way Line Array Column with Adjustable Vertical Coverage and Tapered Horizontal Waveguide

Pattern: Up “Tight”; Down “Narrow” (tight vertical setting; asymmetrical)

Frequency Response & Impedance:

Sensitivity 2.83V @ 1m, and Impedance
“Music” mode (solid) “Speech” Mode (dotted)

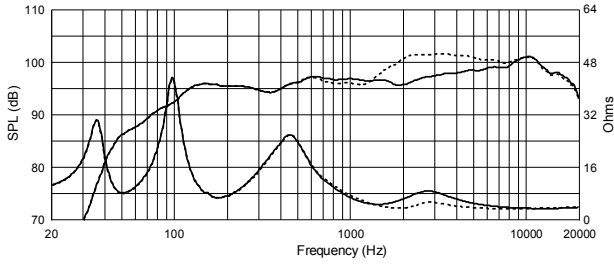

Beamwidth:

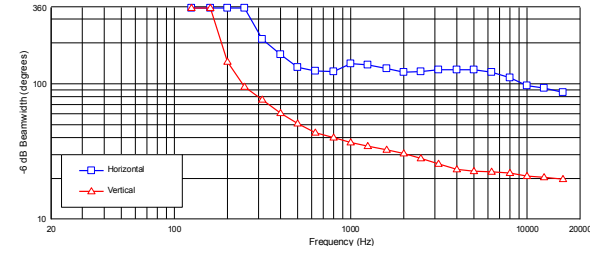

Vertical Off-Axis Frequency Response, Up:

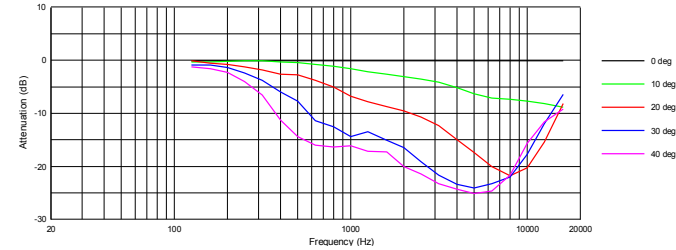

Vertical Off-Axis Frequency Response, Down:

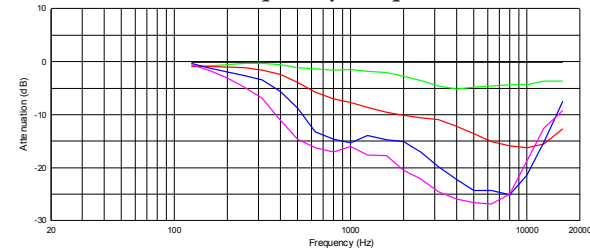

Horizontal Off-Axis Frequency Response:

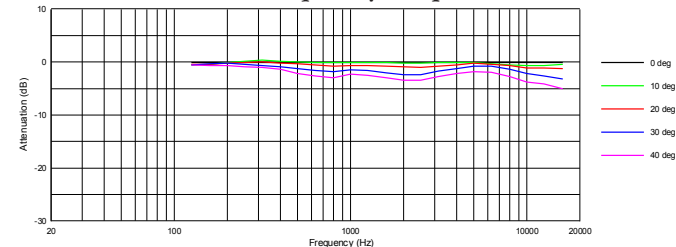

Pattern: Up “Point”; Down “Point” (tightest vertical setting; symmetrical)

Frequency Response & Impedance:

Sensitivity 2.83V @ 1m, and Impedance
“Music” mode (solid) “Speech” Mode (dotted)

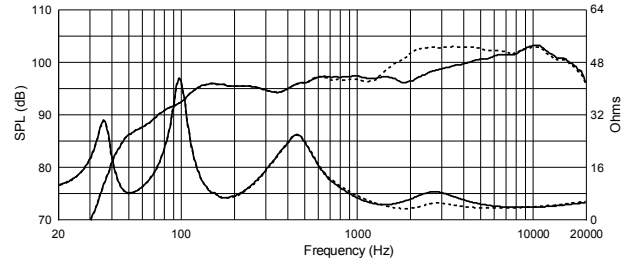

Beamwidth:

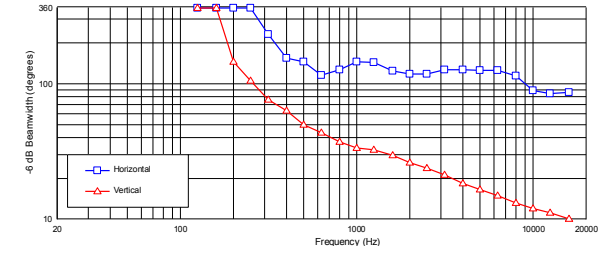

Vertical Off-Axis Frequency Response, Up:

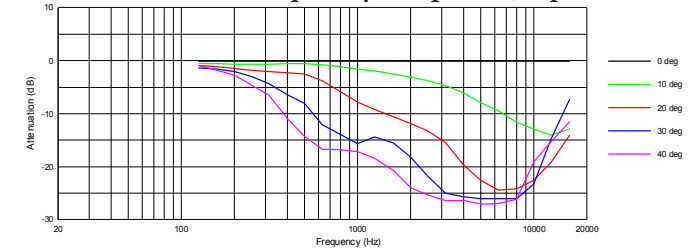

Vertical Off-Axis Frequency Response, Down:

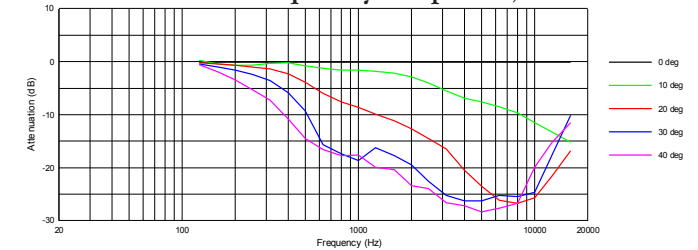

Horizontal Off-Axis Frequency Response:

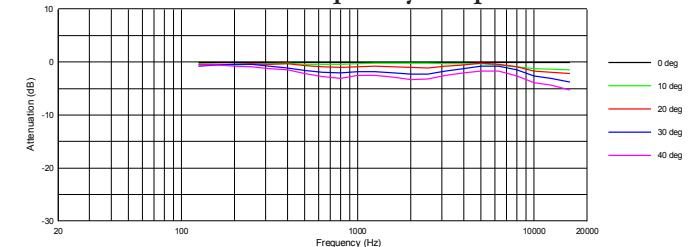

CBT 1000 Two-Way Line Array Column with Adjustable Vertical Coverage and Tapered Horizontal Waveguide

Horizontal Beamwidth

Curves below show beamwidth of tweeter 4th from the top of the array, 12th from the top of the array, from the middle of the array, and 4th from the bottom of the array respectively.

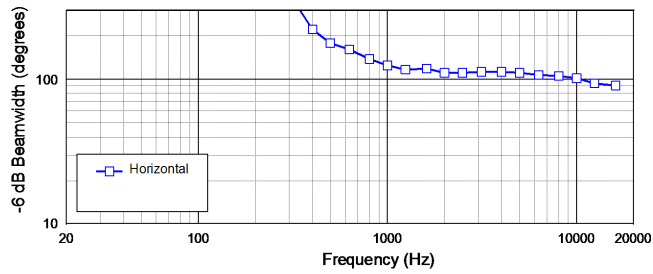

100 Degrees

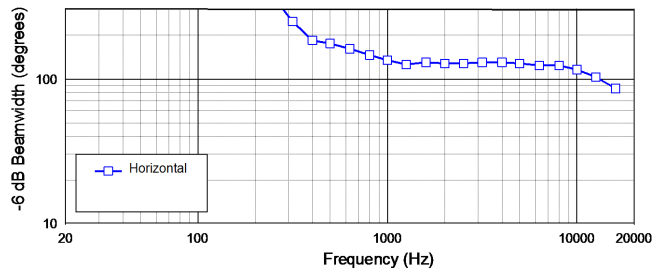

130 Degrees

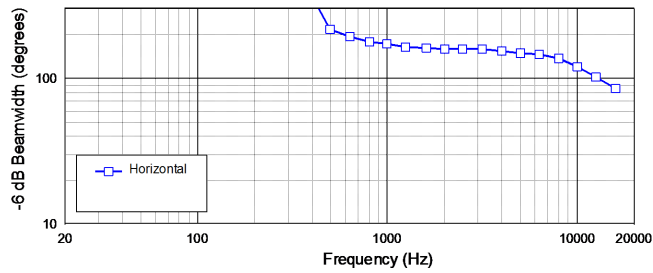

160 Degrees

CBT 1000 Two-Way Line Array Column with Adjustable Vertical Coverage and Tapered Horizontal Waveguide

Dimensions

Dimensions in mm [in]

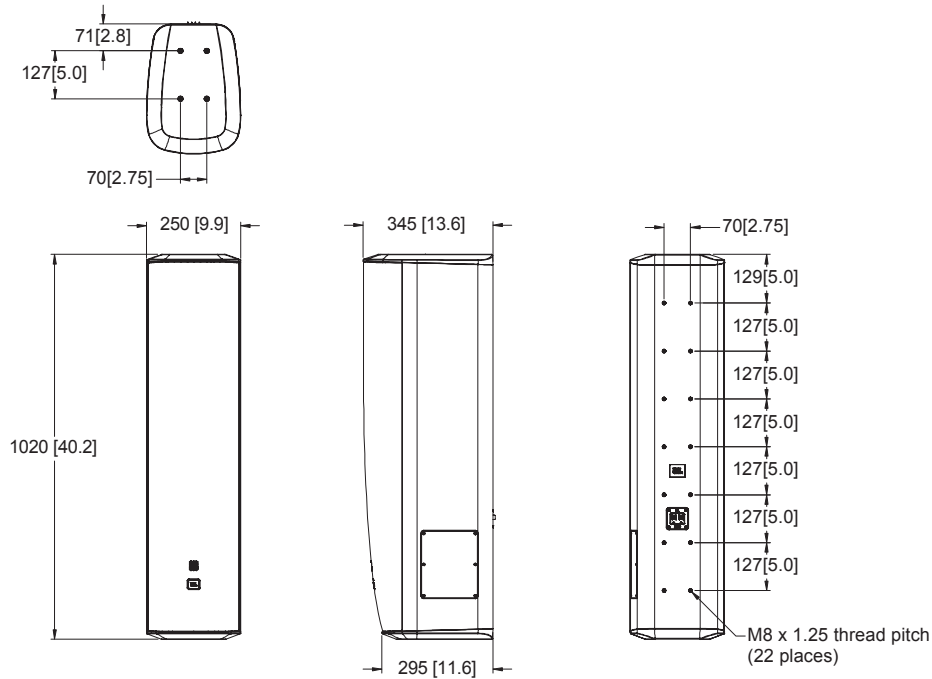

With Included Two-Piece Wall-Mount Bracket

Shown Without Included Swivel Part
(no horizontal panning)

Shown With Included Swivel Part
(for +/- 45 degree horizontal panning)

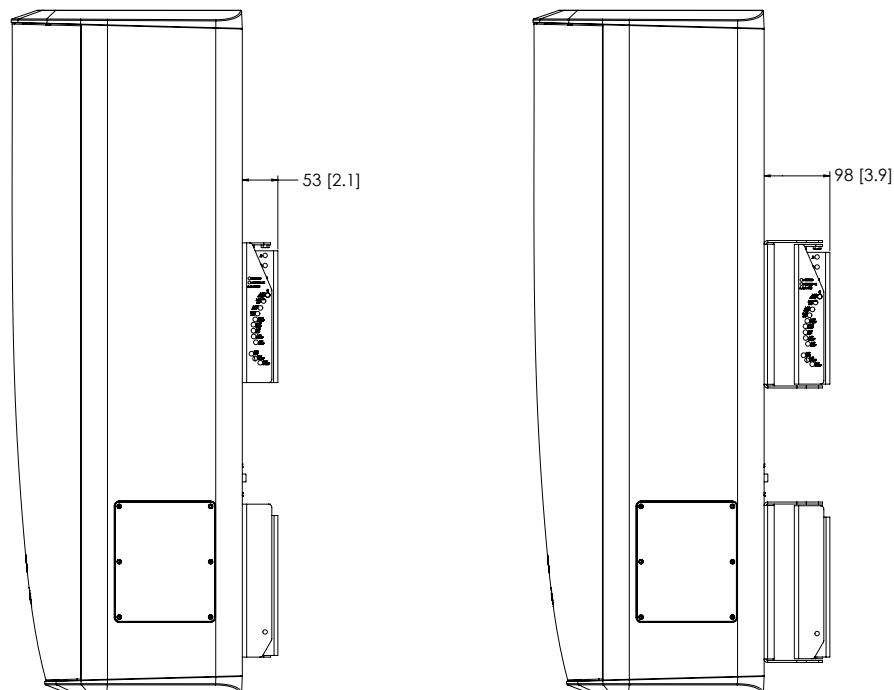

CBT 1000 Two-Way Line Array Column with Adjustable Vertical Coverage and Tapered Horizontal Waveguide

Exploded View Diagram of Included Swivel (Pan) / Tilt Bracket

(Diagram is example only. Consult JBL CBT 1000 Bracket Installation Guide for detailed installation instructions)

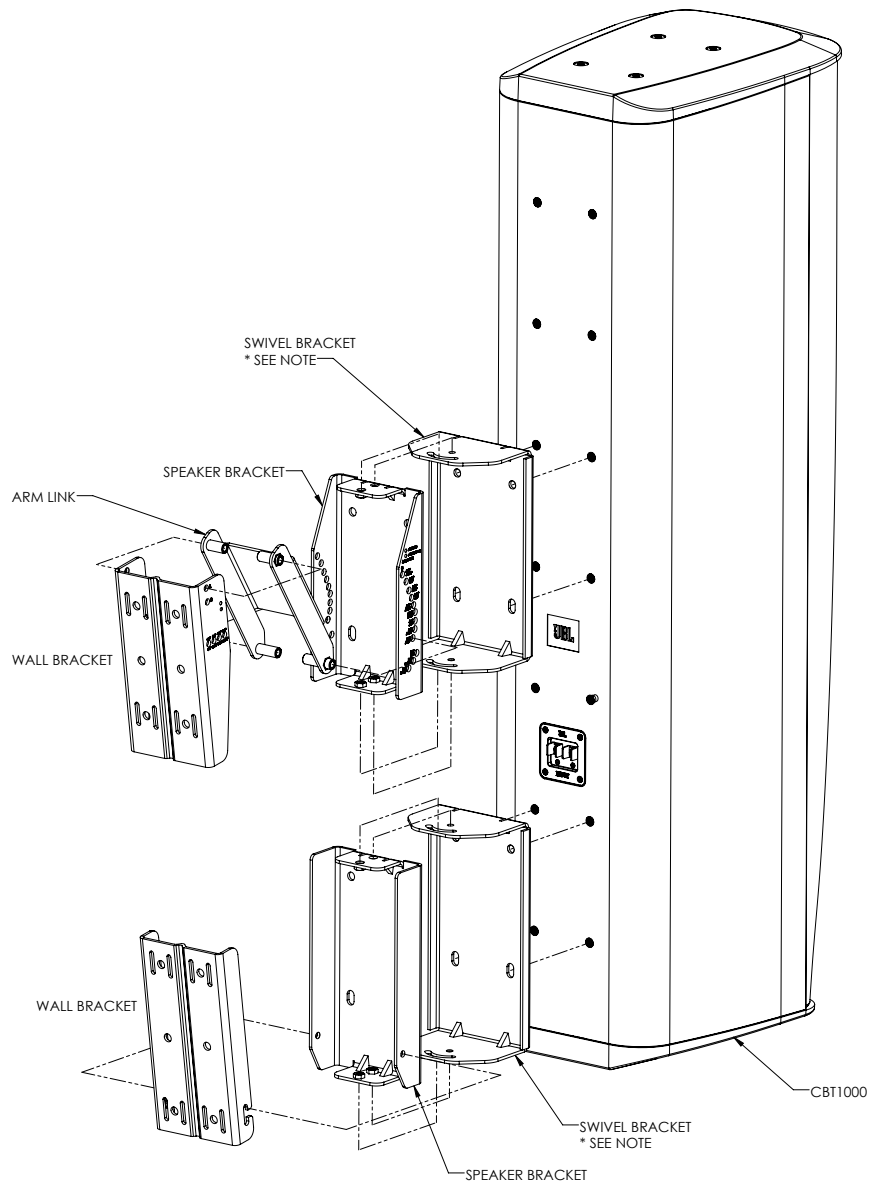

* NOTE: Use SWIVEL BRACKETS when panning is needed for aiming speaker horizontally. When panning is not needed, leave SWIVEL BRACKETS out, and mount SPEAKER BRACKET directly to CBT 1000 cabinet. Diagram is example only. Consult JBL CBT 1000 Bracket Installation Guide for detailed installation instructions.



JBL Professional
8500 Balboa Boulevard, P.O. Box 2200
Northridge, California 91329 U.S.A. ©
Copyright 2020 JBL Professional
www.jblpro.com

SS CBT1K REV A
01/20