

LA-RAK II AVB TOURING RACK



- 12 channels of high power amplification
- AVB, AES, Analog inputs
- Milan seamless dual network redundancy
- Unified and plug-and-play
- Rugged 9U frame
- Usable worldwide (100-240 V, 50/60 Hz)

IN A NUTSHELL



LA-RAK II AVB comes with three-phase 32 A IEC input and link connectors, allowing to link two LA-RAK II AVB. It also comes with a 30 A NEMA connector for 110 V operation. Additional power sockets are available for auxiliary equipment.

Usable worldwide, LA-RAK II AVB facilitates tour logistics and cross-rental between L-Acoustics rental network agents. LA-RAK II AVB is mechanically and electrically compatible with the LA-RAK II and LA-RAK legacy standard.

LA-RAK II AVB is a flyable touring rack offering twelve channels of high power amplification in a 9U frame. It is equipped with three LA12X amplified controllers, two LS10 AVB switches, two panels for mains power and signal distribution and a blank panel. All devices are internally prewired for audio, control and power to offer a plug-and-play solution with seamless networked audio redundancy based on the Milan protocol.

The rugged LA-RAK II AVB features a shock-absorbing inner frame, retractable front and rear doors, a detachable dolly and four handles to facilitate transport and manipulation. An optional flying frame supports up to four LA-RAK II AVB.



SYSTEM COMPONENTS



RK 9U: The 9U rack is a dual structure consisting of a rubber shock inner steel frame braced by an external aluminum frame and sided with highly resistant polyethylene panels. This ensures structural integrity while offering decoupling and maximum protection of the electronics inside the rack. Two retractable LEXAN® doors protect the internal components during transport. At the rear, two hinge-mounted panels cover and protect the analog, digital, and network connectors of the amplified controllers and create a neat and tangle-free cable environment. The RK 9U is equipped with a detachable dolly board and coupling bars for stacking up to 3 LA-RAK II AVB or flying up to 4 LA-RAK II AVB.



LA12X: The LA12X amplified controller operates all L-Acoustics loudspeaker systems. Based on a 4 x 4 architecture, LA12X delivers up to 3300 watts at 2.7 ohms per channel with record hold times. The universal SMPS (100 - 240 V) with Power Factor Correction offers a high tolerance to unstable mains. In a compact and lightweight 2U chassis, LA12X gathers a front panel interface with an LCD display and rotary encoder, two I/O Ethernet connection ports for AVB networked audio and control, a connection panel for analog and AES/EBU, and speaker outputs.



LS10: LS10 is a plug-and-play Avnu-certified AVB switch uniting audio and control distribution to provide a simple and reliable network solution. Two units are coupled side by side in the LA-RAK II AVB via the dedicated 1U rack shelf. LS10 is fitted with eight EtherCON™ connectors for maximum reliability. The rear EtherCON™ connectors of both LS10 are connected to each LA12X for seamless redundancy following the Milan protocol. The front EtherCON™ can be used to receive and send AVB audio and control to other LA-RAK II AVB. The SFP cages provides additional copper ports or optical links in case of long distance connections. For such configuration, the blank panel can be custom fitted with fiber optics connectors.



LA-PANEL II: LA-PANEL II is a 1U front patch panel for analog and digital audio signal distribution feeding the three LA12X with 6 discrete analog and 3 stereo AES/EBU signals with link-out capability to other racks. The analog connectors are compatible with the L-Acoustics 19 points PA-COM® standard. The digital audio signals use XLR connectors.



LA-POWER II: LA-POWER II is a 2U I/O power distribution panel. It automatically balances power with an equal number of LA12X per phase. It features a three-phase NEMA L21-30P input (US mode) and a CEE FORM 400V with a LINK OUT socket to power a second rack (EU mode). A mains switch allows to operate in US or EU mode. A NEMA 5-15 (US mode) and an F "Schuko" socket (EU mode) are also available to power auxiliary equipment. The auxiliary circuit features a 10 A breaker. Three LEDs help monitor the presence of each phase on the front end of the mains circuit regardless of the position of the mains switch.

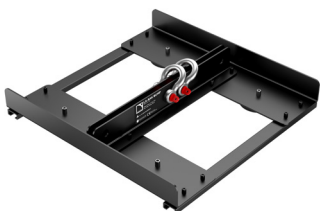

LA-RAK BUMP: LA-RAK BUMP is engineered to fly up to 4 LA-RAK II for a drive capacity of up to 24 K1 enclosures. It can be flown from one or two pick-points and secured to an additional safety point. Its structure features a bolted assembly for better visual safety verification and is protected by a weather resistant coating.

USER INTERFACE

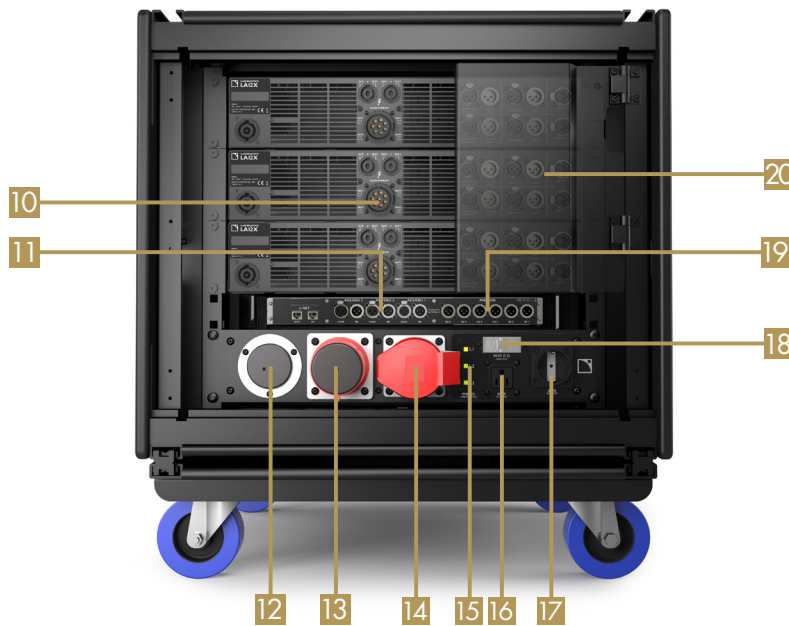

- | | | | |
|----|---|----|--|
| 1 | LA12X amplified controllers | 11 | AES/EBU internal input/link (6 XLR connectors) |
| 2 | Analog input/link (2 PA-COM® connectors) | 12 | 3P+N+E input (NEMA L21-30P, US mode) |
| 3 | LS10 AVB switch | 13 | 3P+N+E input (CEE FORM 400V, EU mode) |
| 4 | Removable dolly board | 14 | 3P+N+E link (CEE FORM 400V, EU mode) |
| 5 | Coupling bars | 15 | Phase presence LEDs (L1, L2, L3) |
| 6 | AES/EBU input/link (6 XLR connectors) | 16 | Auxiliary output (10 A NEMA 5-15 socket, US mode) |
| 7 | L-NET input/link (Unused) | 17 | Auxiliary output (10 A type F "Shuko" socket, EU mode) |
| 8 | Storage slots for front and rear doors | 18 | Circuit breaker (AUX L3) |
| 9 | Assembly rails (flying and stacking) | 19 | Analog internal inputs (6 XLR connectors) |
| 10 | LA12X speaker output panel (total: 3 PA-COM® + 6 SpeakON® connectors) | 20 | Hinge-mounted panels for connector protection |

ASSEMBLY PRINCIPLES

LA-RAK II stacking (max. 3 LA-RAK II)

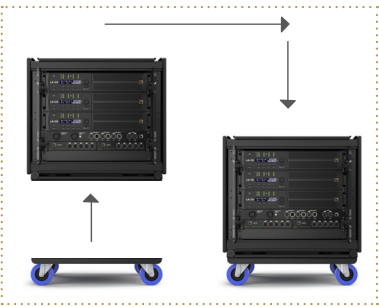

Stacking onto K1-BUMP (max. 4 LA-RAK II + 24 K1)

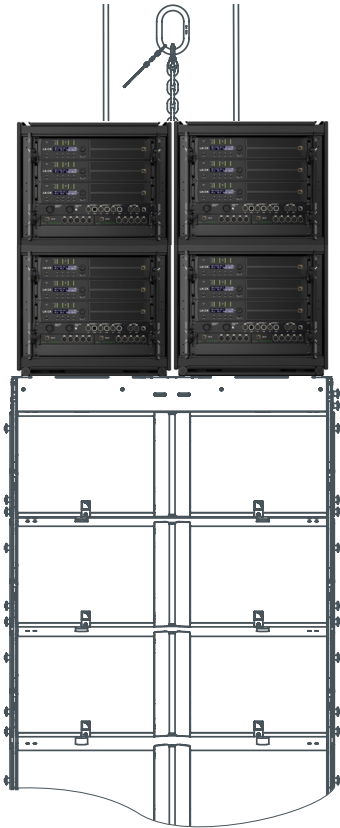

Flying under LA-RAK BUMP (max. 4 LA-RAK II)



CABLING SCHEMATICS

Power

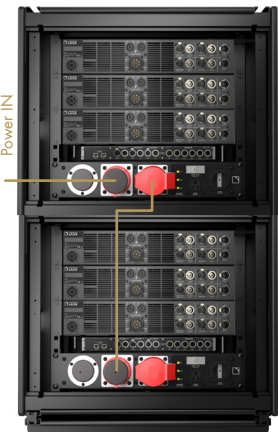

Analog audio

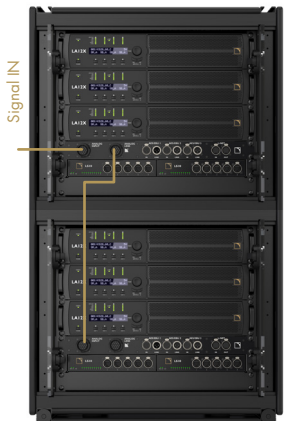

AES/EBU audio

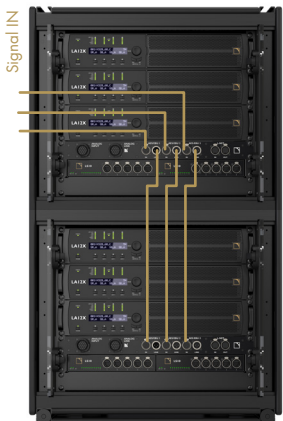

AVB audio and control

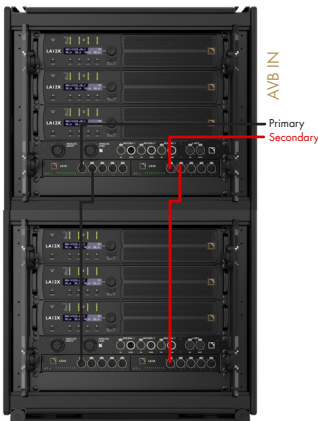

External
Internal



LA-POWER II rear view



To primary LS10
To secondary LS10

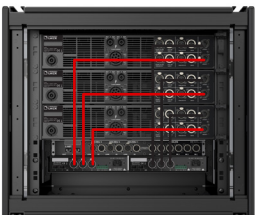

Primary
Secondary

LA-POWER II invisible

AUDIO AND CONTROL CONNECTION EXAMPLE

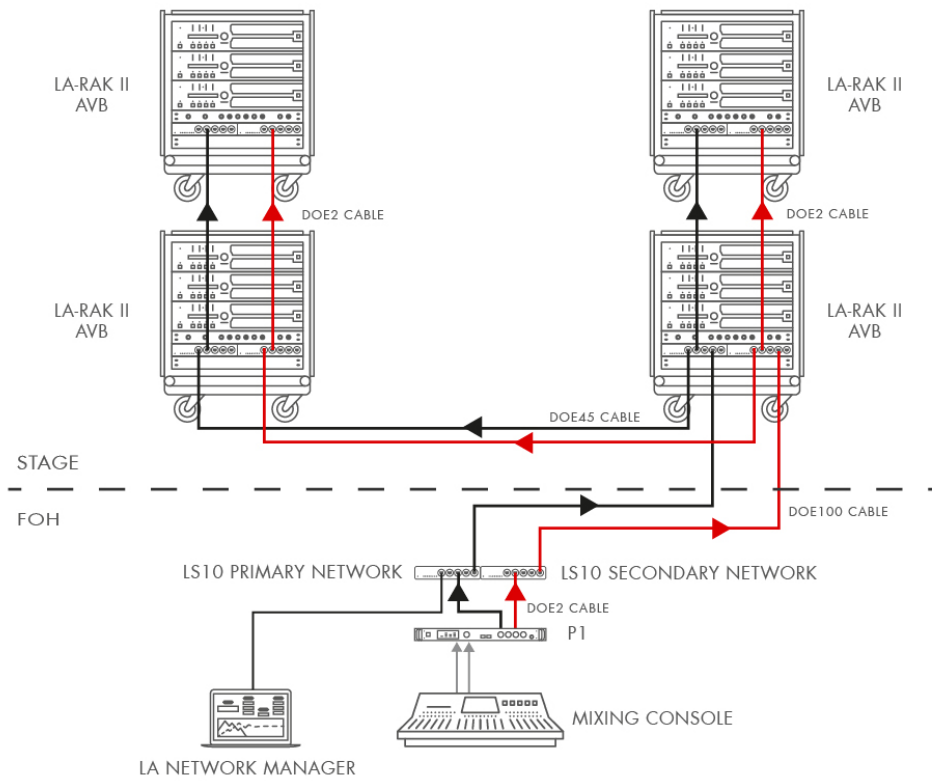

LOUDSPEAKER CONNECTION EXAMPLES

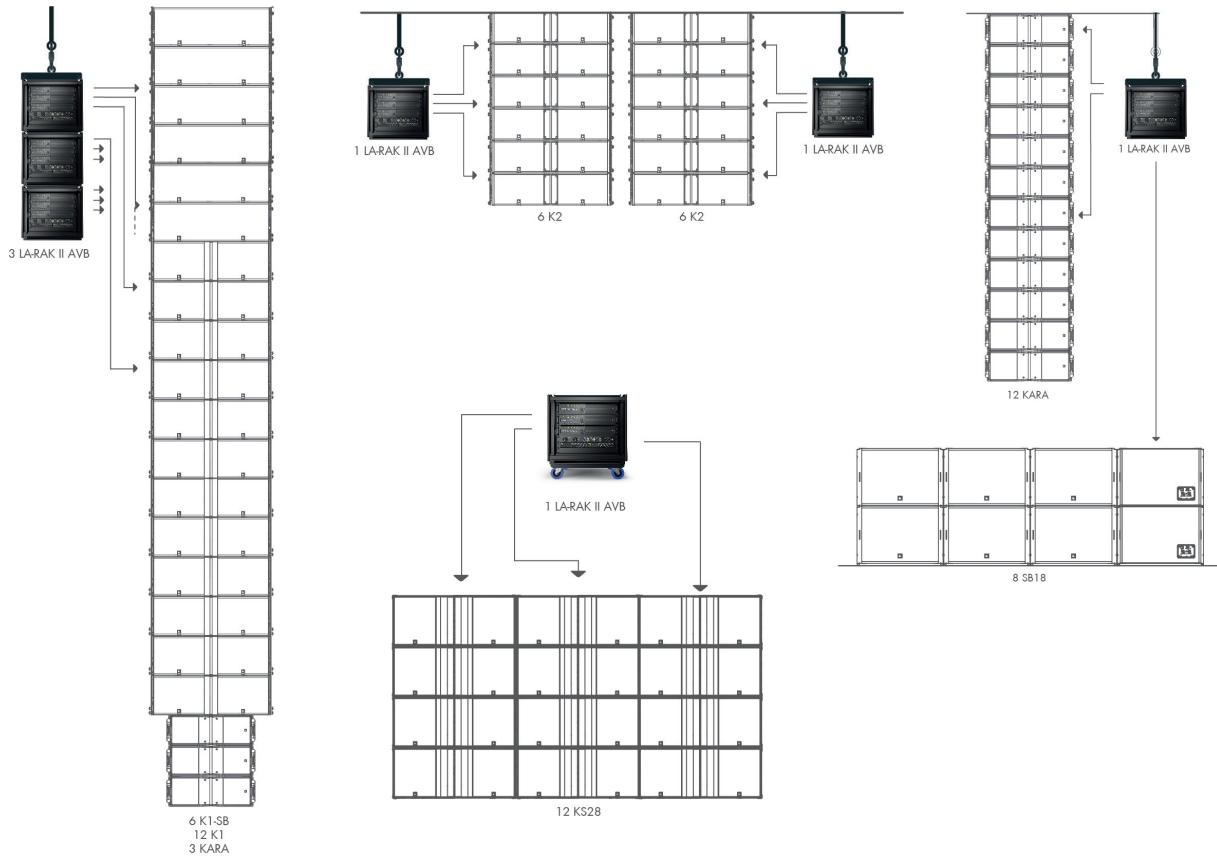

LA-RAK II AVB TOURING RACK



LA-RAK II AVB is a flyable touring rack offering twelve channels of amplification in a 9 U frame. Three LA12X amplified controllers, two LS10 AVB switches and power and signal distribution panels are internally prewired to offer a plug-and-play, reliable solution that allows for seamless networked audio redundancy based on the Milan protocol.

The rugged LA-RAK II AVB features a shock-absorbing inner frame, protective and handling elements to ease transport and manipulation. With power connectors for any voltage standard, LA-RAK II AVB can be used worldwide to facilitate tour logistics and cross-rental between L-Acoustics rental network agents.

SPECIFICATIONS

LA-RAK II AVB

Content	3 x LA12X amplified controller 2 x LS10 AVB switch 1 x LA-PANEL II 1 x LA-POWER II 2 x doors, cables and 2 x coupling bars
Weight (net)	101.5 kg / 223.8 lb (with all the above)
Material	Polyethylene, aluminium and steel external structure, LEXAN® polycarbonate doors
Rigging and handling	2 x coupling bars, dolly board

LA-PANEL II

Front	
Analog input/link	2 x 19-point CA-COM
AES/EBU input/link	3 x female Neutrik® XLR3 (IN) / 3 x male Neutrik® XLR3 (LINK)
Network	2 x etherCON® (L-NET IN/OUT) - Unused
Rear	
Analog input	6 x male Neutrik® XLR3 (IN 1 to IN 6)
AES/EBU input/link	3 x female Neutrik® XLR3 (IN) / 3 x male Neutrik® XLR3 (LINK)
Network	2 x RJ45 (L-NET) - Unused

LA-POWER II

Front	
AC input (US)	30 A - NEMA L21-30P (3P+N+E) male outlet
AC input/link out (EU)	32 A - IEC 60309 (3P+N+E) male outlet 32 A - IEC 60309 (3P+N+E) female outlet DANGER: Do not use with a 120 - 208 V power supply.
AC presence	3 x dual LEDs: Left: US AC input / right: EU AC input
AC auxiliary output (US)	NEMA 5-15 female outlet (AUX US MODE)
AC auxiliary output (EU)	Type F «Schuko» female outlet (AUX EU MODE)
Protection	10 A type C circuit breaker (AUX L3)
Rear	
AC output for LA12X	3 x power cords fitted with 32 A Neutrik powerCON® connectors (AMP 1 L1, AMP 2 L2, AMP 3 L3)
AC input selector switch	Switch between EU MODE and US MODE Important: Do not switch mode when connected to power supply.
AC output for LS10	2 x IEC 60320-1 type C13 female outlets (AUX L3)

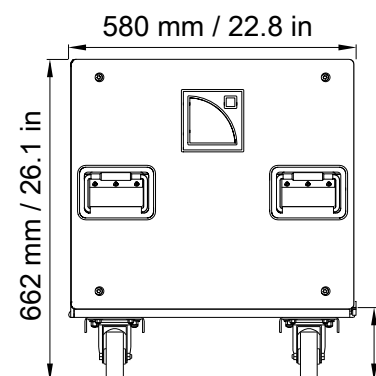
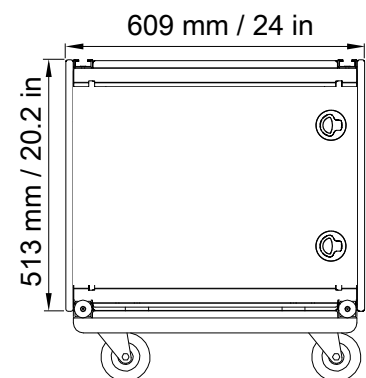

146 mm / 5.7 in

LA12X AMPLIFIED CONTROLLER



LA12X is a four-channel amplified controller designed to power the largest loudspeakers in the L-Acosutics catalog. LA12X features a proprietary switch mode power supply (SMPS) with DSP-controlled power factor correction (PFC) capable of delivering 12,000 watts of output power with record hold times.

The universal SMPS (100 - 240 V) allows worldwide operation of LA12X with identical performance while the PFC grants a high tolerance to unstable mains with low power consumption. The 4 x 4 architecture offers both flexibility to power a high density of passive loudspeakers and a powerful amplification for large format active enclosures.

Package in a 2U chassis, LA12X integrates powerful DSP resources with built-in loudspeaker optimization tools and the proprietary L-DRIVE system to protect the loudspeakers and the amplified controller. Beyond analogue and AES inputs, LA12X features AVB inputs and allows for seamless redundancy following the Milan protocol.

SPECIFICATIONS

Amplification and power supply	
Amplification class	Class D
Output power CEA-2006 / 490 A 1 % THD, 1 kHz, all channels loaded	4 x 1400 W (8 Ω) 4 x 2600 W (4 Ω) 4 x 3300 W (2.7 Ω)
Power supply model	Universal Switched Mode Power Supply (SMPS) with Power Factor Correction (PFC)
Mains rating	100 V - 240 V ~ ±10%, 50-60 Hz
Audio specifications	
Frequency response (20 Hz - 20 kHz, 8 Ω load, 60 W output power)	± 0.1 dB
Distortion THD+N (20 Hz - 10 kHz, 8 Ω load, 60 W output power)	< 0.1%
Output dynamic range (20 Hz - 20 kHz, 8 Ω, A-weighted)	> 114 dB
Noise level (20 Hz - 20 kHz, 8 Ω, A-weighted)	< -72 dBV
DSP	
Digital Signal Processor (DSP)	2x SHARC 32-bit, floating point, 96 kHz sampling rate
I/O routing	Flexible 4x4 routing matrix
Per output channel	Built-in EQ station with 8 IIR, 3 FIR EQ filters Array morphing (LF contour, zoom factor), Air absorption compensation filters Internal IIR and FIR EQ algorithms for speaker phase linearization and improved impulse responses L-DRIVE protection (excursion, temperature and over-voltage) Output delay from 0 to 1000 ms
Circuits protection	
Mains and power supply	Over and under voltage / over temperature / overcurrent / inrush current protection
Power outputs	Over current limiting / DC / short circuit / over temperature
Inputs / Outputs	
Analog input	4 balanced analog line inputs with passively connected link
AES / EBU Input	4 channels (2xAES3) with electronically buffered link and failsafe relay 44.1 - 192 kHz sampling rate
AVB input with support of Milan seamless redundant networking	4 channels from 1 stream of up to 8 channels at 48kHz or 96 kHz
Loudspeaker output	2 x 4-point speakON connector 1 x 8-point CA-COM connector
Remote control and monitoring	
Network connection	Dual-port Ethernet Gigabit interface
Third-party management solutions	QSC® / SNMP / Extron® / Crestron®
Physical data	
Height	2U
Weight	14.5 kg / 32 lb



LS10 AVB SWITCH



LS10 is a plug-and-play Avnu-certified AVB switch that integrates seamlessly within the L-Acoustics ecosystem to further simplify connectivity, uniting audio and control distribution. LS10 runs out-of-the-box AVB, providing a reliable network solution that does not require IT expertise.

On its own or as an integral part of the LA-RAK II AVB, LS10 distributes audio and control via front and rear EtherCON™ connectors and SFP cages, enabling long-distance optical links. Two units mounted side-by-side on LS10-RAKSHELF, the dedicated 1U rack shelf, allow to create a seamless redundant network effortlessly. Upgrading LA-RAK II to LA-RAK II AVB is possible.

The rugged LS10 incorporates features designed to overcome the challenges of touring events but also installation applications. The quick, 5-second, startup time allows for rapid recovery in case of power loss. A configurable GPO port enables status monitoring and the auxiliary DC input offers ultimate reliability.

With LS10, lightning-quick setup of a stable distribution of your AVB signal is ensured without the need for extensive IT knowledge or experience.

SPECIFICATIONS

General	
Mains rating	100 V - 240 V AC (± 10%), 50 Hz - 60 Hz
Power consumption	10 W (normal operation) 20 W (redundancy operation)
Operating temperature	-5 °C / 23 °F to 50 °C / 122 °F
Connectors	
Network connectivity	8 Neutrik EtherCON™ (5 on Front, 3 on Rear) 2 SFP cages (Rear) compliant with SFP transceivers
Power connectivity	1 IEC inlet with lock compatible to Schurter V-Lock™ 1 redundant 24V DC power input 1 redundant 24V DC power output
User configurable GPO	1 potential free GPO on Phoenix connector
AVB	
AVB Ports	10 AVB ports at 1 Gb/s
AVB Bridge	IEEE 802.1BA-2011 standard Augmented by Avnu ProAV 1.1 requirements
Number of supported streams	150
Time to forward AVB streams after power up	5 seconds
Features	
Management	gPTP grandmaster capable RSTP
Port Sensing	Auto negotiation
Auto Crossover	MDI / MDIX (allows to use straight or cross cables)
Auto Sensing	Full or Half Duplex
Interface	Power status LED, fault status LED link up/activity status LEDs Reset to factory settings button micro USB
Physical data	
Height x Width	1.7" x 9,5" (1U x 1/2 U)
Weight	1.5 kg / 2.2 lb

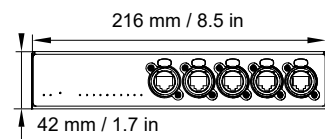

Front

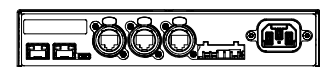

Rear

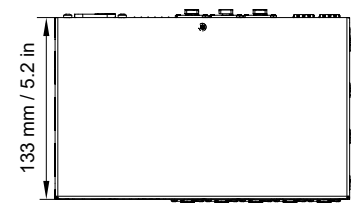

Top