



QLX-D (Asia)

Wireless System

Shure QLXD wireless system user guide. Includes dimensions, frequency bands, solutions to error codes, and more.
Version: 6.0 (2020-H)

Table of Contents

QLX-D (Asia) Wireless System	4	System Set Up	32
IMPORTANT SAFETY INSTRUCTIONS	4	Creating Audio Channels	32
WARNING	5	Scan and IR Sync	32
Important Product Information	5	Step 1: Scanning to Find the Best Channel	32
LICENSING INFORMATION	5	Network Scan	33
Information to the user	6	Step 2: IR Sync for Automatic Transmitter Set Up	33
Australia Warning for Wireless	6	Manual Channel Assignment	34
System Overview	6	Manual Frequency Selection	34
Features	7	Linking Two Transmitters to a Receiver	35
System Components	7	Radio Frequency (RF) Settings	36
Quick Start	9	Setting the Transmitter RF Power	36
Wearing the Bodypack Transmitter	12	Shure AXT600 Spectrum Manager Compatibility	37
Hardware Interface	12	Using QLX-D with a Shure ULX-D System	37
Receiver Front and Back Panels	13	Setting Regional TV Channel Spacing	38
Receiver Display	15	Custom Groups	38
Navigating the Receiver Menus	17	Networking	40
Transmitters	19	Connecting to a Network	40
Transmitter Display	20	Automatic IP Addressing	41
Transmitter Menu Options and Navigation	22	Configuration Tips	41
Control Lock Options for the Receiver and Transmitter	23	Network Troubleshooting	41
Battery Installation	25	Setting the IP Address and Subnet Mask Manually	41
Setting the AA Battery Type	26	Connecting to an External Control System	43
Shure SB900 Rechargeable Battery	26	Managing Your System with Shure Software	43
AA Battery Installation	28	Firmware Updates	43
Low Battery Alert	29	Firmware Versioning	44
Receiver Gain Adjustment	30	Downloading and Updating Firmware	44
Audio Signal Encryption	31	Updating the Receiver	44
		Updating the Transmitter	44
		Troubleshooting	45
		Error Codes and Solutions	47

Single and Dual Rackmount Assembly	48	Specifications	56
Securing the AC Power Cord	49	QLXD4	57
Installing Footpads	49	QLXD1	58
		QLXD2	59
Accessories	49	Receiver Output Connectors	61
Optional Accessories	50	TA4M Input Connector Diagram	62
Hardware, Cases, and Accessories	53	Frequency Range and Transmitter Output Power	63
Cables and Connectors	53		
In-Line Amplifiers and Antennas	54	Certifications	64
UHF Antenna Power Distribution Amplifiers	55	QLXD1, QLXD2, QLXD4	65
Active Antenna Splitters	55	QLXD1, QLXD2	65
Batteries and Chargers	55	QLXD4	65

QLX-D (Asia) Wireless System









IMPORTANT SAFETY INSTRUCTIONS

1. READ these instructions.
2. KEEP these instructions.
3. HEED all warnings.
4. FOLLOW all instructions.
5. DO NOT use this apparatus near water.
6. CLEAN ONLY with dry cloth.
7. DO NOT block any ventilation openings. Allow sufficient distances for adequate ventilation and install in accordance with the manufacturer's instructions.
8. DO NOT install near any heat sources such as open flames, radiators, heat registers, stoves, or other apparatus (including amplifiers) that produce heat. Do not place any open flame sources on the product.
9. DO NOT defeat the safety purpose of the polarized or grounding type plug. A polarized plug has two blades with one wider than the other. A grounding type plug has two blades and a third grounding prong. The wider blade or the third prong are provided for your safety. If the provided plug does not fit into your outlet, consult an electrician for replacement of the obsolete outlet.
10. PROTECT the power cord from being walked on or pinched, particularly at plugs, convenience receptacles, and the point where they exit from the apparatus.
11. ONLY USE attachments/accessories specified by the manufacturer.
12. USE only with a cart, stand, tripod, bracket, or table specified by the manufacturer, or sold with the apparatus. When a cart is used, use caution when moving the cart/apparatus combination to avoid injury from tip-over.



13. UNPLUG this apparatus during lightning storms or when unused for long periods of time.
14. REFER all servicing to qualified service personnel. Servicing is required when the apparatus has been damaged in any way, such as power supply cord or plug is damaged, liquid has been spilled or objects have fallen into the apparatus, the apparatus has been exposed to rain or moisture, does not operate normally, or has been dropped.
15. DO NOT expose the apparatus to dripping and splashing. DO NOT put objects filled with liquids, such as vases, on the apparatus.
16. The MAINS plug or an appliance coupler shall remain readily operable.
17. The airborne noise of the Apparatus does not exceed 70dB (A).
18. Apparatus with CLASS I construction shall be connected to a MAINS socket outlet with a protective earthing connection.
19. To reduce the risk of fire or electric shock, do not expose this apparatus to rain or moisture.
20. Do not attempt to modify this product. Doing so could result in personal injury and/or product failure.
21. Operate this product within its specified operating temperature range.

Explanation of Symbols

	Caution: risk of electric shock
	Caution: risk of danger (See note.)
	Direct current
	Alternating current
	On (Supply)
	Equipment protected throughout by DOUBLE INSULATION or REINFORCED INSULATION
	Stand-by
	Equipment should not be disposed of in the normal waste stream

WARNING: Voltages in this equipment are hazardous to life. No user-serviceable parts inside. Refer all servicing to qualified service personnel. The safety certifications do not apply when the operating voltage is changed from the factory setting.

WARNING: Danger of explosion if incorrect battery replaced. Operate only with AA batteries.

Note: Use only with the included power supply or a Shure-approved equivalent.

WARNING

- Battery packs may explode or release toxic materials. Risk of fire or burns. Do not open, crush, modify, disassemble, heat above 140°F (60°C), or incinerate.
- Follow instructions from manufacturer
- Only use Shure charger to recharge Shure rechargeable batteries
- **WARNING:** Danger of explosion if battery incorrectly replaced. Replace only with same or equivalent type.
- Never put batteries in mouth. If swallowed, contact your physician or local poison control center
- Do not short circuit; may cause burns or catch fire
- Do not charge or use battery packs other than Shure rechargeable batteries
- Dispose of battery packs properly. Check with local vendor for proper disposal of used battery packs.
- Batteries (battery pack or batteries installed) shall not be exposed to excessive heat such as sunshine, fire or the like
- Do not immerse the battery in liquid such as water, beverages, or other fluids.
- Do not attach or insert battery with polarity reversed.
- Keep away from small children.
- Do not use abnormal batteries.
- Pack the battery securely for transport.

Important Product Information

LICENSING INFORMATION

Licensing: A ministerial license to operate this equipment may be required in certain areas. Consult your national authority for possible requirements. Changes or modifications not expressly approved by Shure Incorporated could void your authority to

operate the equipment. Licensing of Shure wireless microphone equipment is the user's responsibility, and licensability depends on the user's classification and application, and on the selected frequency. Shure strongly urges the user to contact the appropriate telecommunications authority concerning proper licensing, and before choosing and ordering frequencies.

Information to the user

This device complies with part 15 of the FCC Rules. Operation is subject to the following two conditions:

1. This device may not cause harmful interference.
2. This device must accept any interference received, including interference that may cause undesired operation.

Note: This equipment has been tested and found to comply with the limits for a Class B digital device, pursuant to part 15 of the FCC Rules. These limits are designed to provide reasonable protection against harmful interference in a residential installation. This equipment generates uses and can radiate radio frequency energy and, if not installed and used in accordance with the instructions, may cause harmful interference to radio communications. However, there is no guarantee that interference will not occur in a particular installation. If this equipment does cause harmful interference to radio or television reception, which can be determined by turning the equipment off and on, the user is encouraged to try to correct the interference by one or more of the following measures:

- Reorient or relocate the receiving antenna.
- Increase the separation between the equipment and the receiver.
- Connect the equipment to an outlet on a circuit different from that to which the receiver is connected.
- Consult the dealer or an experienced radio/TV technician for help.

Australia Warning for Wireless

This device operates under an ACMA class licence and must comply with all the conditions of that licence including operating frequencies. Before 31 December 2014, this device will comply if it is operated in the 520-820 MHz frequency band.

WARNING: After 31 December 2014, in order to comply, this device must not be operated in the 694-820 MHz band.

Note: EMC conformance testing is based on the use of supplied and recommended cable types. The use of other cable types may degrade EMC performance.

Please follow your regional recycling scheme for batteries, packaging, and electronic waste.

Caution: Avoid operating mobile phones and mobile broadband devices near your wireless system to prevent the possibility of interference.

System Overview

QLX-D[®] Digital Wireless delivers defined, streamlined performance with transparent 24-bit digital audio. Combining professional features with simplified setup and operation, QLX-D offers outstanding wireless functionality for demanding live sound events and installations.

Shure digital wireless technology enables QLX-D to transmit clearly detailed audio with extended, virtually flat frequency response. Designed to be highly RF spectrum efficient, QLX-D can operate more than 60 compatible channels simultaneously in a single frequency band. Automatic channel scan and IR sync make finding and assigning an open frequency quick and easy. Ethernet connection provides networked channel scanning across multiple receivers and Shure Wireless Workbench[®] control software compatibility for advanced frequency coordination. AES-256 encryption comes standard and can be easily enabled for secure wireless transmission.

QLX-D also adds Shure rechargeable power options to provide dramatic long-term cost savings and extended transmitter battery life over alkaline batteries, and battery metering that reports remaining runtime in hours and minutes. With clearly defined performance and innovation, QLX-D delivers the very latest in digital wireless technology from Shure.

Features

- Transparent 24-bit digital audio
- Extended 20 Hz to 20 kHz frequency range (microphone dependent)
- 120 dB dynamic range
- Digital predictive switching diversity
- 64 MHz tuning bandwidth (region dependent)
- More than 60 available channels per frequency band (region dependent)
- Up to 17 compatible systems per 6MHz TV band; 22 systems per 8 MHz band
- Easy pairing of transmitters and receivers over IR scan and sync
- Automatic channel scan
- Ethernet networking for multiple receiver systems
- Network channel scanning configures open frequencies for networked receivers
- Compatible with Shure Wireless Workbench 6 control software
- Remote control from a mobile device or tablet via ShurePlus™ Channels app
- AES-256 encryption for secure wireless transmission
- Elegant and easy-to-use interface with high-contrast LCD menu
- Compatible with external control systems such as AMX or Crestron
- Professional-grade all-metal construction
- Transmitters use 2 AA batteries or Shure SB900 rechargeable battery

System Components



- ① QLXD4 Receiver
- ② PS24 Power Supply
- ③ 1/2 Wave Antennas (2)
- ④ 2 ft. BNC Cables with Bulkhead Adapters (2)
- ⑤ Choice of QLXD1 Bodypack Transmitter or QLXD2 Handheld Transmitter
- ⑥ AA Alkaline Batteries (not included in Argentina)

⑦ Rackmount Hardware

Model Variations

Model variations with additional components are available to meet specific performance situations.

QLXD2 Handheld Transmitter

Includes QLXD2 Handheld, available with any of the following microphone cartridges:

- SM58
- Beta 58A
- SM86
- Beta 87A
- SM87A
- Beta 87C
- KSM9
- KSM9HS (black)

Microphone Clip

Battery Contact Cover

Zipper Bag

QLXD1 Bodypack Guitar System

Includes QLXD1 bodypack transmitter

WA305 Premium instrument cable

Zipper Bag

QLXD1 Bodypack Headworn or Lavalier

Includes QLXD1 bodypack, available with any of the following microphone cartridges:

- Beta 98H/C
- WL93
- WL183
- WL184
- WL185
- MX150 (omni)
- MX150 (cardioid)
- MX153 (black or tan)
- SM35

Zipper Bag

Bodypack and Handheld Combo System

- QLXD1 bodypack transmitter with WL185 Microflex cardioid lavalier microphone
- QLXD2 handheld transmitter with Shure SM58 microphone cartridge
- Battery Contact Cover
- Zipper Bag (2)

Quick Start

Step 1: Power and Antenna Connection

- ① Connect an antenna to each of the antenna connectors.
- ② Connect the power supply to the receiver and plug into an AC power source.
- ③ Connect the receiver audio output to a mixer or amplifier.
- ④ Press and hold the power button to turn on the receiver.

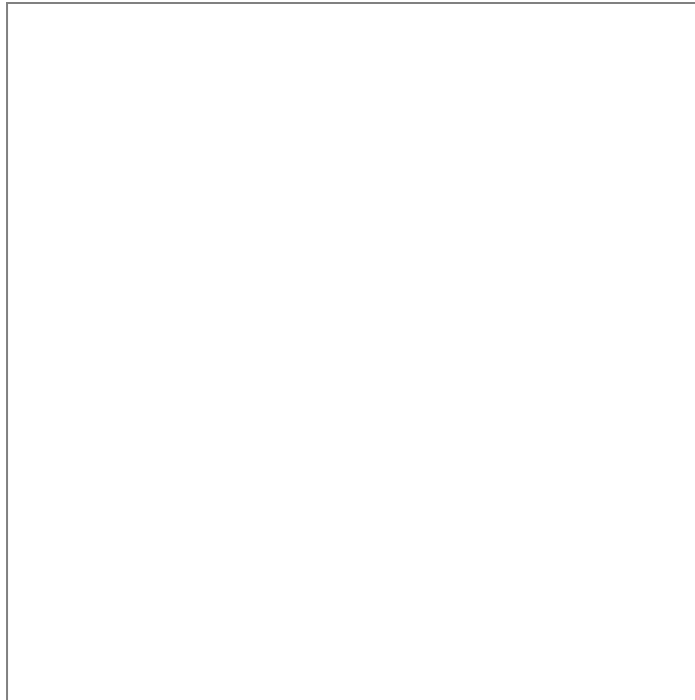

Step 2: Scanning for the Best Available Channel

1. Press the menu button on the receiver to access the scan function.

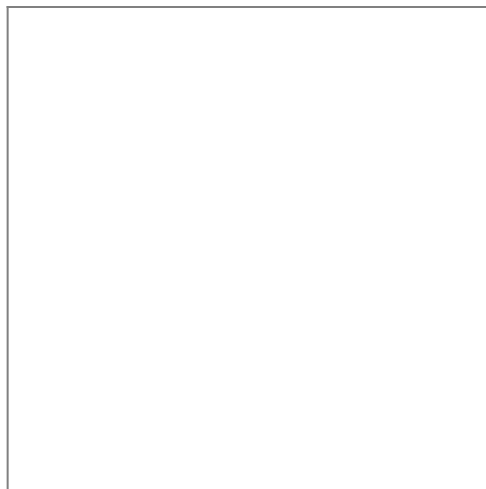

2. Press the enter button to start a frequency scan. The scan icon will flash while in scan mode. When the scan is complete, the selected channel appears on the display.

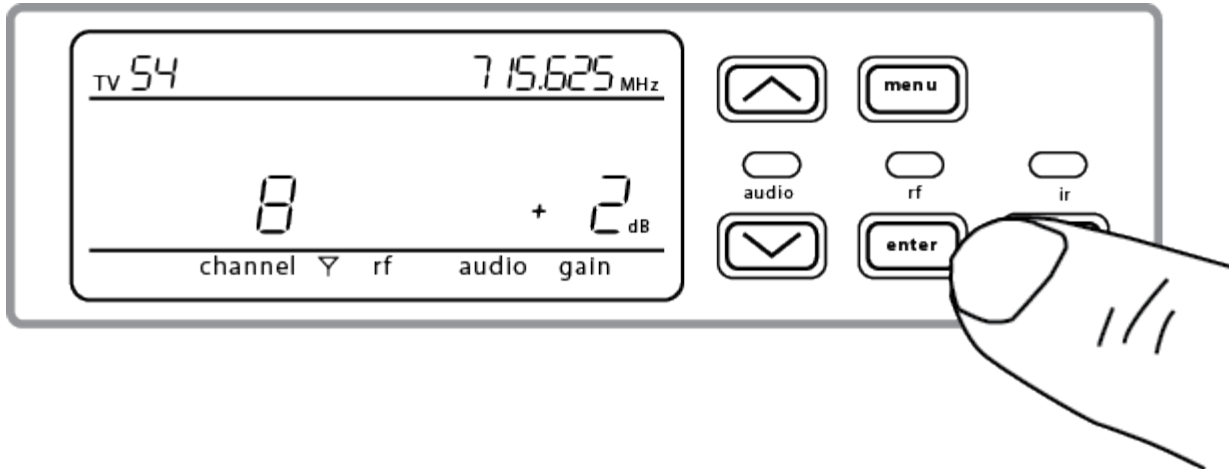

Step 3: Install Batteries into Transmitter



① Accessing the Battery Compartment

Press the side tabs on the bodypack or unscrew the cover on the handheld as shown to access the battery compartment.

② Installing Batteries

- **AA Batteries:** Place batteries (note polarity markings) and AA Adaptor as shown
- **Shure SB900 Battery:** Place battery as shown (note polarity markings), remove AA Adaptor from bodypack transmitter, stow AA Adaptor in door for handheld transmitter

Note: If using AA batteries, select a battery type from the transmitter menu to ensure accurate battery metering.

Step 4: IR Sync to Create an Audio Channel

1. Turn on the transmitter.
2. Press the sync button on the receiver. The red ir LED will blink indicating that sync mode is active.
3. Align the IR sync windows of the transmitter and receiver at a distance of <15 cm (6 in.). When the transmitter and receiver are aligned, the red ir LED remains on and the sync will automatically occur.

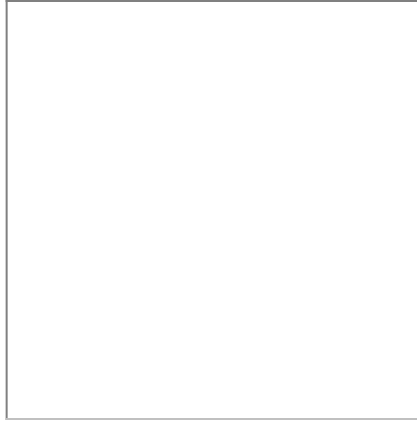

4. sync good appears on the display when IR sync is complete. The blue rf LED will illuminate indicating that the transmitter is within range of the receiver.

Note: If the IR sync fails, repeat the IR sync procedure, carefully maintaining alignment between the IR windows of the transmitter and receiver.

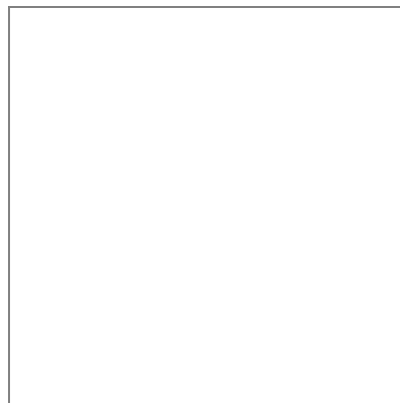
**Step 5: Sound Check and Gain Adjustment**

1. Test the transmitter at performance levels while monitoring the audio meter and the audio LED. The audio meter should display at least 3 bars and the audio LED should be green. Reduce the gain if there is audible distortion of the audio.
2. Increase or decrease the gain if necessary by pressing the arrow buttons on the receiver front panel.

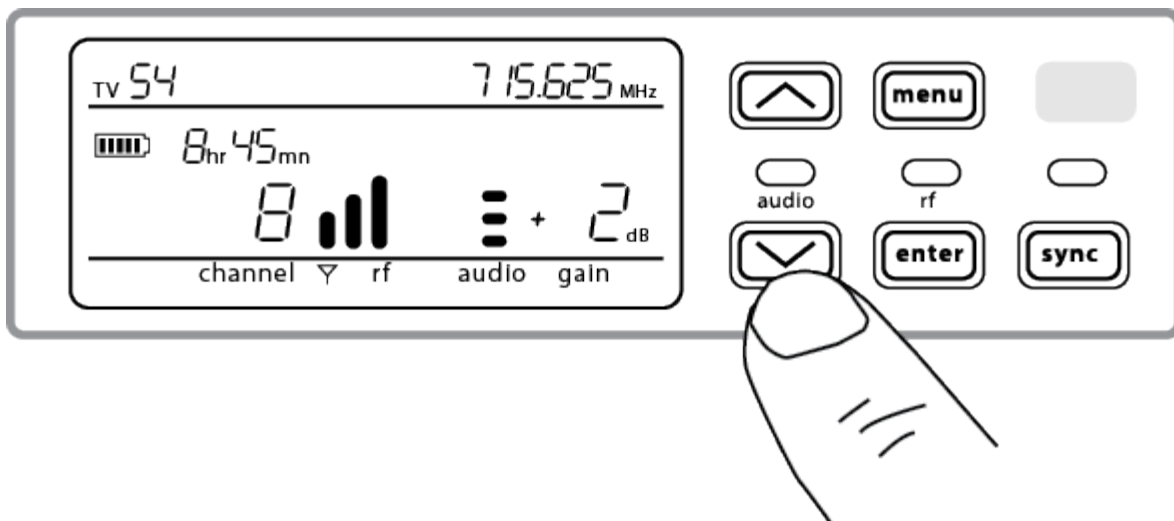

Wearing the Bodypack Transmitter

Clip the transmitter to a belt or slide a guitar strap through the transmitter clip as shown.

For best results, the belt should be pressed against the base of the clip.

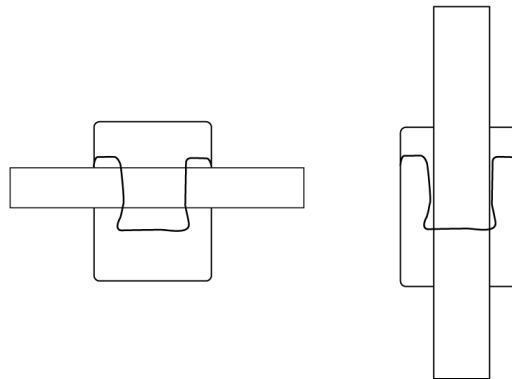

Hardware Interface

Receiver Front and Back Panels

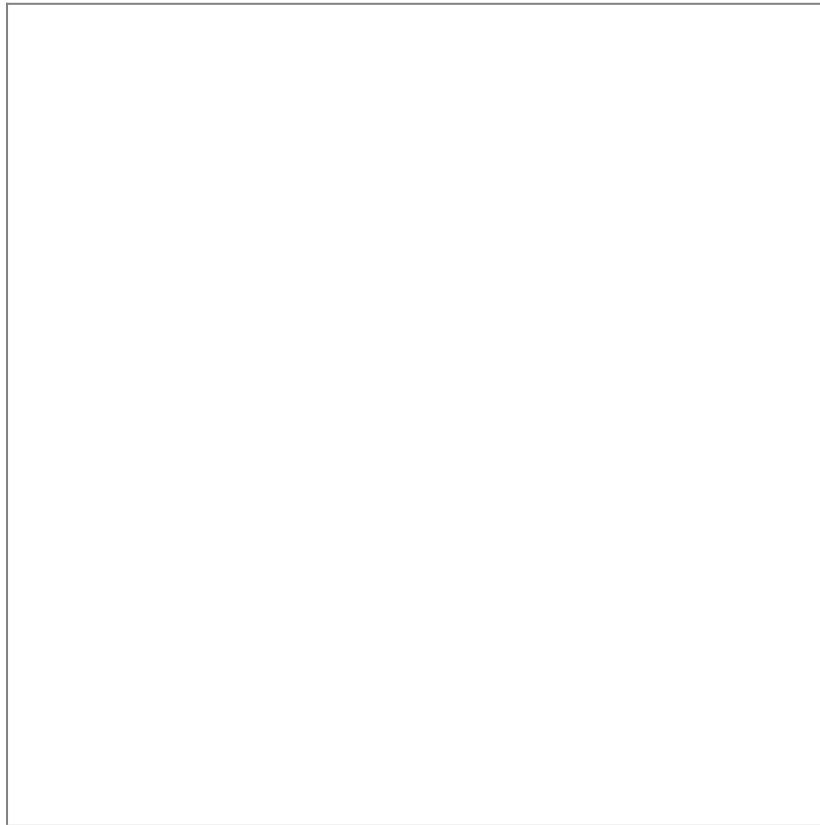

① Display

Shows menu options, receiver and transmitter settings.

② Arrow Buttons

Adjust gain setting or change menu parameters.

③ Enter Button

Press to save menu or parameter changes.

④ Sync Button

Press to activate IR sync.

⑤ Power Switch

Powers receiver on or off.

⑥ Audio LED

- Green = normal
- Yellow = signal approaching limiter threshold
- Red = limiter engaged to prevent clipping

⑦ Menu Button

- Press to access or select menu screens
- Press to cancel pending changes
- Press and hold to return to the home screen

⑧ RF LED

Illuminates when RF link with transmitter is active.

⑨ IR Window

Align with the transmitter IR window during an IR sync to automatically program transmitters.

⑩ Sync LED

- Blinking: IR sync mode is enabled
- On: Receiver and transmitter aligned for IR sync

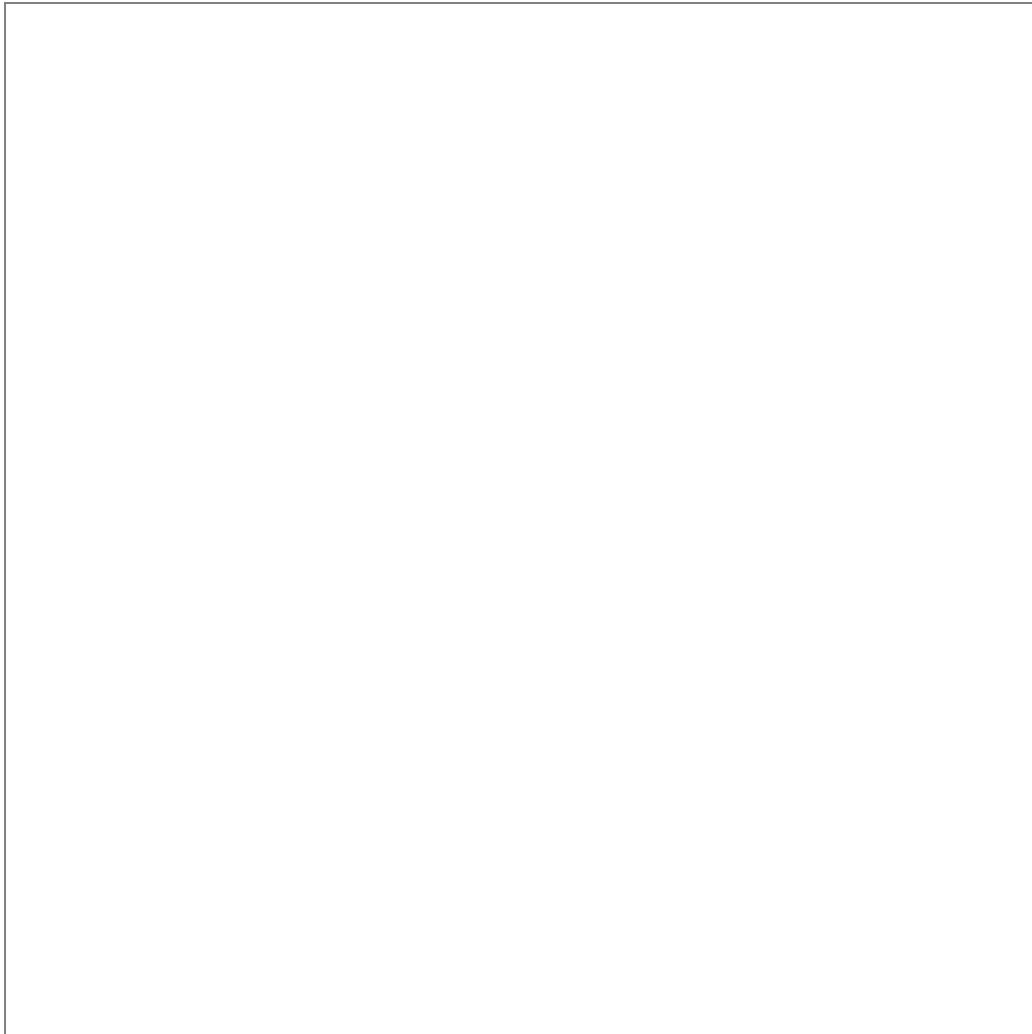

⑪ Power Cord Strain Relief

Secures power cord.

⑫ Power Supply Jack

Connection point for DC power supply.

⑬ Ethernet Port

For network connection.

- Amber LED (network speed):
off = 10 Mbps, on = 100 Mbps
- Green LED (network status):
off = no network link, on = network link active
flashing = rate corresponds to traffic volume

⑭ Receiver Reset

Press to restore receiver default settings.

⑮ Antenna Connectors

BNC connector for receiver antennas

⑯ Mic/Line Switch

Sets output level to microphone or line.

⑰ XLR Audio Output

Balanced (1: ground, 2: audio +, 3: audio -)

⑱ 1/4" Instrument/Auxiliary Output

Impedance Balanced (Tip: audio, Ring: no audio, Sleeve: ground)

Receiver Display

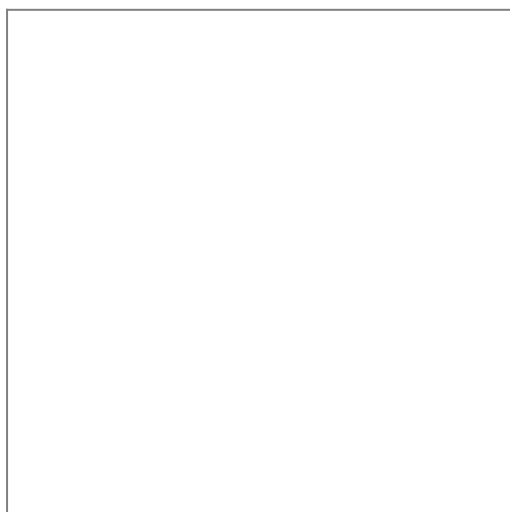

Displays channel setting.

② Active Antenna Indicator

Illuminates to indicate which antenna is active.

③ RF Signal Meter

Number of bars displayed corresponds to RF signal level - OL = overload.

④ Audio Meter

Number of bars displayed corresponds to audio level.

- OL = Illuminates when receiver audio limiter is active to prevent clipping
- TxOL = Illuminates when transmitter input is overloaded. Reduce input from microphone or instrument to prevent clipping.

⑤ Gain Level

Displays receiver gain setting in 1 dB increments.

⑥ Receiver Lock Status

Lock icon and name of locked control:

- menu
- power
- gain

⑦ Frequency Setting

Selected frequency (MHz).

⑧ Encryption Status

Illuminates when encryption is enabled.

⑨ Scan

Displayed when scan function is active.

⑩ Network Scan

Displayed when network scan function is active in multi-receiver systems.

⑪ Network Connection Indicator

Illuminates when additional Shure components are detected on the network.

⑫ TV Channel

Displays the number of the TV channel containing the selected frequency.

⑬ Transmitter Battery Icon

Indicates remaining battery life.

Enable the Low Battery Alert to flash the receiver display when battery runtime is less than 30 minutes.

⑭ SB900 Battery Runtime

When the transmitter is powered by a Shure SB900 rechargeable battery, remaining runtime is displayed in hours:minutes.

Navigating the Receiver Menus

The receiver has a main menu for setup and configuration and an advanced menu to access additional receiver functions.

Main Menu

Press the menu button to access the menu. Each additional press of the menu button advances to the next menu screen in the following order:

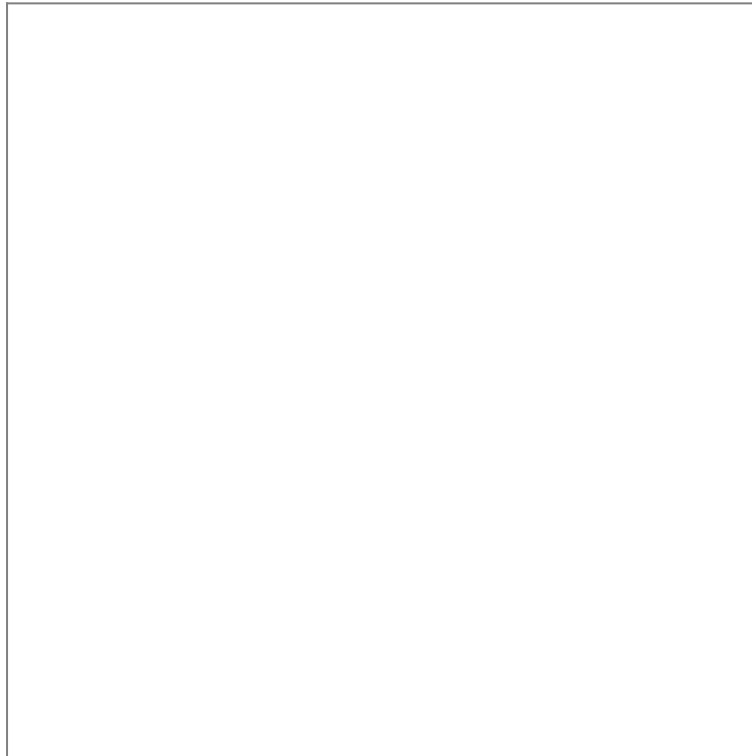

① Scan

Receiver automatically scans for the best available frequency

② Network Scan

Scans to find frequencies for networked receivers operating in the same frequency band

③ Channel

Edit the receiver channel settings

④ Lock

Choose a control lock option

⑤ Encryption

Use the arrow buttons to enable encryption (on) or disable encryption (off)

⑥ Frequency

Use the arrow buttons to edit the frequency value

Advanced Menu

Starting from the main menu home screen, press menu while holding the enter button to access the advanced menu. Each additional press of the menu button advances to the next menu screen in the following order.

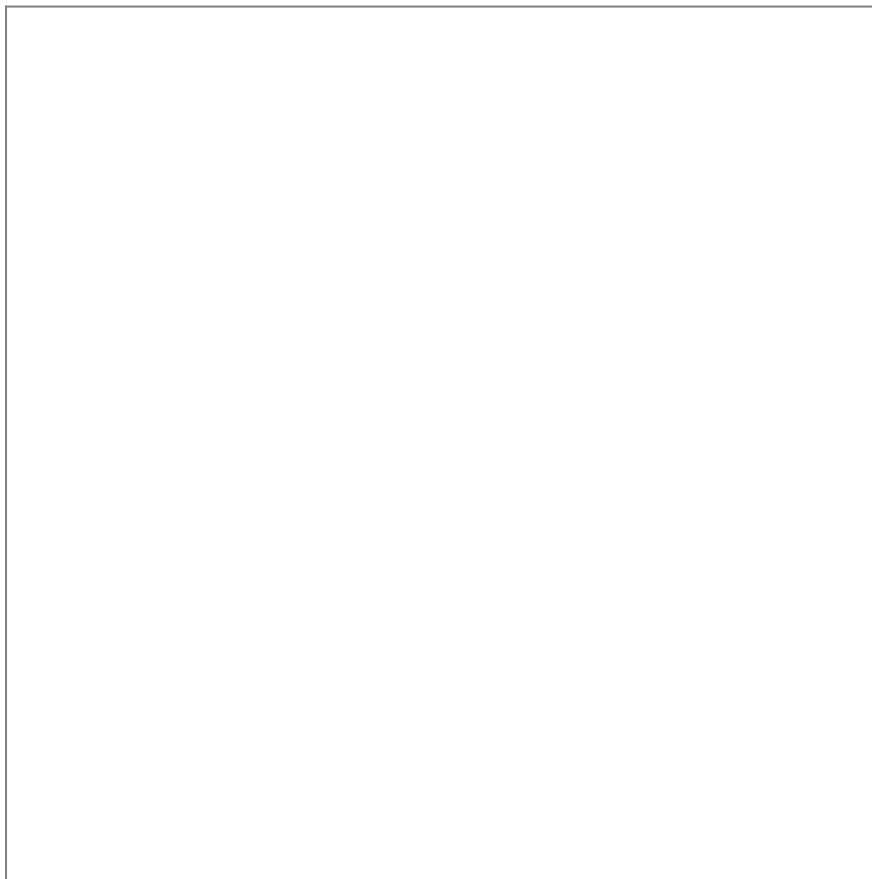

① Custom Groups

Use to add channels and frequencies to Custom Groups

② TV Channel Spacing

Selects the regional bandwidth for TV channel display

③ Low Battery Alert

Enable or disable the low battery alert on the receiver screen

④ Boundary/Gooseneck Transmitter Presets

Sends ULXD6/ULXD8 presets configured in WWB to transmitters via the IR Sync window

⑤ Firmware Update

Displays what kind transmitter firmware the receiver has available. See Firmware Updates for more details.

- HH BP = handheld or bodypack firmware
- BN GN = boundary or gooseneck firmware

⑥ IP Settings

Use to select and edit IP settings and subnet masks

⑦ Network Reset

Returns network settings and IP address to default setting

⑧ Factory Reset

Restores factory settings

For application and configuration details, see the related guide topic for each advanced feature.

Tips for Editing Menu Parameters

- To increase, decrease or change a parameter, use the arrow buttons
- A menu setting will blink when editing is enabled
- To save a menu change, press enter
- To exit a menu without saving a change, press menu
- To access the advanced menu, press menu while holding the enter button from the home screen
- To return to the home screen from any menu without saving changes, press and hold the menu button.

Transmitters

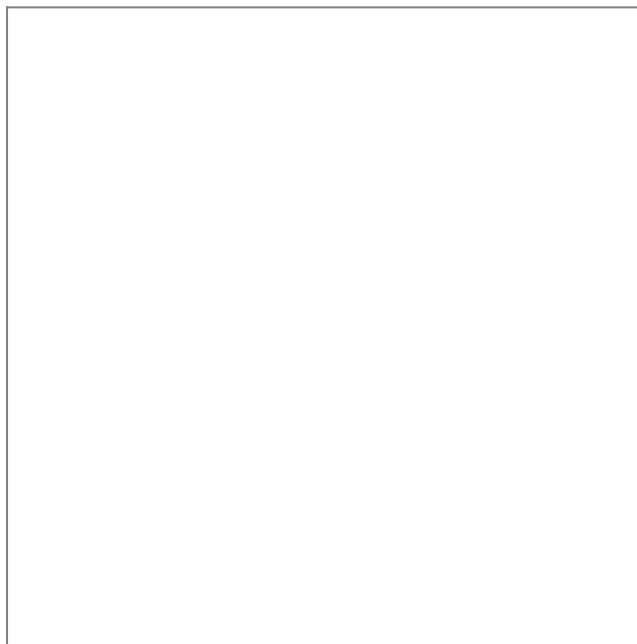

① Power LED

- Green = unit is powered on
- Red = low battery

② On/Off Switch

Powers the transmitter on or off.

③ Display:

View menu screens and settings. Press any control button to activate the backlight.

④ IR window

Align with the receiver IR window during an IR sync for automated transmitter programming.

⑤ Menu Navigation Buttons

menu = Use to navigate between menu screens.

▼ ▲ = Use to select menu screens, edit menu parameters, or choose a home screen display option.

enter = Press to confirm and save parameter changes.

Tip: Press the menu button to exit without saving parameter changes.

⑥ Battery Compartment

Requires 2 AA batteries or a Shure SB900 rechargeable battery.

⑦ AA Battery Adapter

Secures batteries when powering transmitter with AA batteries instead of Shure SB900 battery.

⑧ Bodypack Antenna

For RF signal transmission.

⑨ Handheld Integrated Antenna

For RF signal transmission.

⑩ Microphone Cartridge

See Optional Accessories for a list of compatible cartridges.

⑪ TA4M Input Jack

Connects to a 4-Pin Mini Connector (TA4F) microphone or instrument cable.

⑫ Battery Contact Cover

Align the cover as shown to prevent reflections from the battery contacts during broadcasts or performances.

Transmitter Display

① Battery Indicator

Bars displayed indicate remaining battery life.

② Home Screen Display: Channel/Frequency/SB900 Battery Runtime

Use the arrow keys to select one of the following home screen displays:

Channel	SB900 battery runtime	Frequency
---------	-----------------------	-----------

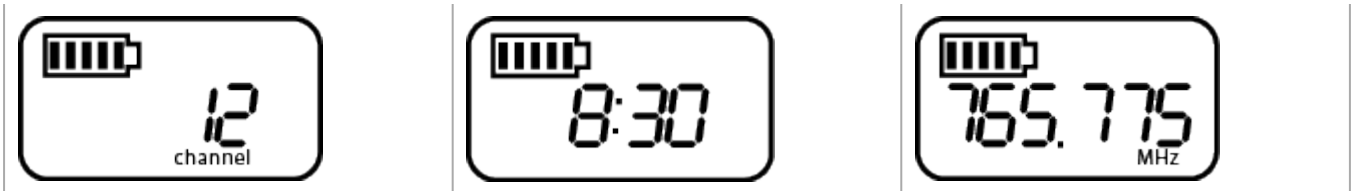

③ Encryption Status

Icon displayed when encryption is enabled.

④ Lock

Displayed when transmitter controls are locked.

⑤ RF Power

RF power setting (Lo or Hi).

⑥ Mic Offset

Displays mic offset level in 3 dB increments.



Transmitter controls

- To increase, decrease or change a parameter, use the ▼ ▲ buttons
- To save a menu change, press enter
- To exit a menu without saving a change, press the menu button

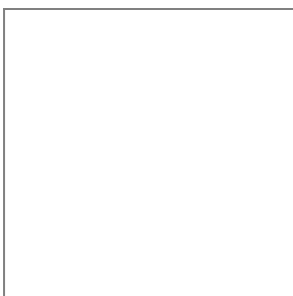
**Bodypack****Handheld**

Transmitter Menu Options and Navigation

The transmitter features individual menu screens for setting up and adjusting the transmitter. To access the menu options from the home screen, press the menu button. Each additional press of the menu button advances to the next menu screen.

① Home Screen

Use the arrow keys to select one of the following home screen displays:

- Battery Icon and channel
- Battery Icon/frequency
- Battery Icon/Battery Runtime (SB900 installed)

② channel

Use the arrow buttons to scroll through the channels.

③ frequency

Use the arrow buttons to adjust the frequency. Press and hold for faster scrolling.

④ lock

Select a lock option:

- On = controls locked
- OFF = controls unlocked

⑤ rf power

Select an rf power setting:

- Lo = 1 mW
- Hi = 10 mW

⑥ mic offset dB

Use to match audio levels between two transmitters used in a combo system. Range is 0 to 21 dB (3 dB increments). Adjustments occur in realtime.

⑦ battery type

Use to set the battery type to match the installed AA battery type to ensure accurate battery metering. Menu is not displayed when Shure SB900 batteries are installed.

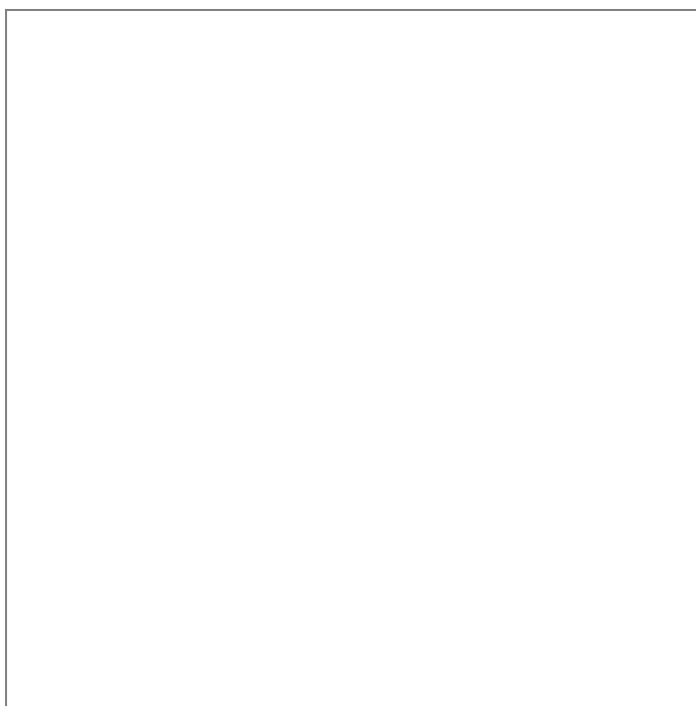

Tips for Editing Menu Parameters

- To access the menu options from the home screen, press the menu button. Each additional press of the menu button advances to the next menu screen.
- A menu parameter will blink when editing is enabled
- To increase, decrease or change a parameter, use the arrow buttons
- To save a menu change, press enter
- To exit a menu without saving a change, press menu

Control Lock Options for the Receiver and Transmitter

Control lock options are available for both the receiver and the transmitter to protect against accidental or unauthorized changes. Locks can be directly set from the component menu, or remotely set from WWB6. To maintain protection, controls remain locked when the transmitter is turned off and turned on.

Locking and Unlocking the Receiver Controls

The receiver has the following control lock options which can be used separately or in any combination:

- gain: locks the arrow buttons to prevent changes to the audio gain settings
- menu: prevents access to menu items and IR sync (gain controls and power switch remain active)
- power: disables power switch (gain and menu controls remain active)

To lock a receiver control:

1. Press the menu button to navigate to the lock settings.
2. Use the arrow buttons to add or remove the lock options shown next to the lock icon.
3. Press enter to save the lock settings.

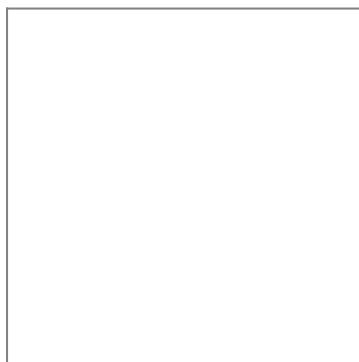

To unlock a receiver:

Tip: To unlock the menu and clear all locks, press and hold the menu button while in the home screen until the unlock icon appears. Press enter to confirm and save change.

1. To unlock gain or power settings, navigate to the lock settings by pressing the menu button.
2. Press the arrow buttons to de-select a lock option.
3. Press enter to confirm and save change.

Locking and Unlocking Transmitter Controls

The transmitter controls can be locked or unlocked by selecting On (locked) or OFF (unlocked) from the transmitter lock menu.

If an attempt is made to access a locked control, the lock icon will flash, indicating that the transmitter controls are locked.

To set a transmitter lock:

1. Press the menu button to navigate to the lock settings.
2. Use the arrow buttons to select on.
3. Press enter to save. The lock icon appears on the display to confirm that the control locks are enabled.

To unlock the transmitter:

1. Press and hold the menu button until OFF and the unlock icon appear on the display.
2. Press enter to save changes.

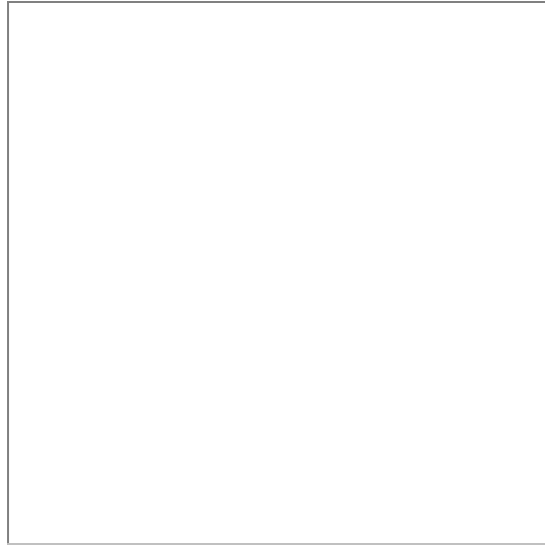

Battery Installation

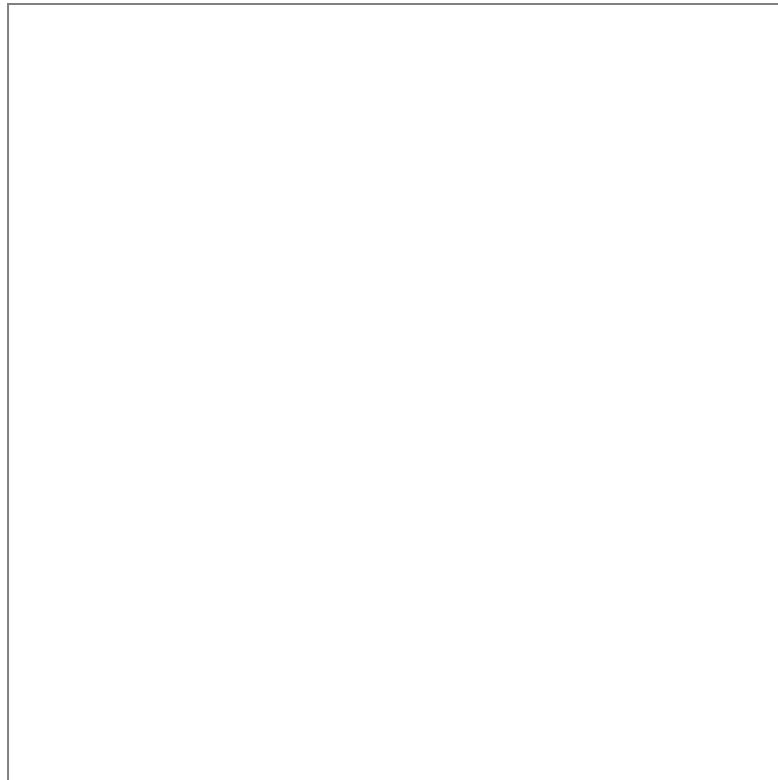

① Accessing the Battery Compartment

Press the side tabs on the bodypack or unscrew the cover on the handheld as shown to access the battery compartment.

② Installing Batteries

- **AA Batteries:** Place batteries (note polarity markings) and AA Adaptor as shown
- **Shure SB900 Battery:** Place battery as shown (note polarity markings), remove AA Adaptor from bodypack transmitter, stow AA Adaptor in door for handheld transmitter

Note: If using AA batteries, set the battery type using the transmitter menu.

Setting the AA Battery Type

To ensure accurate display of transmitter runtime, set the battery type in the transmitter menu to match the installed AA battery type. If a Shure SB900 rechargeable battery is installed, selecting a battery type is not necessary and the battery type menu will not be displayed.

1. Press the menu button to navigate to the battery icon.
2. Use the ▼ ▲ buttons to select the installed battery type:
 - AL = Alkaline
 - nH = Nickel Metal Hydride
 - Li = Lithium Primary
3. Press enter to save.

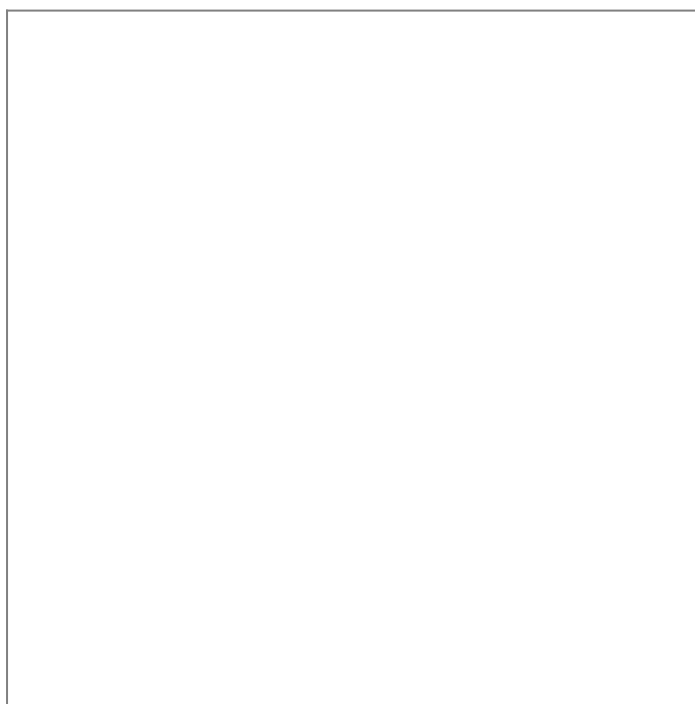

Shure SB900 Rechargeable Battery

Shure SB900 lithium-ion batteries offer a rechargeable option for powering the QLX-D transmitters. Batteries quickly charge to 50% capacity in one hour and reach full charge within three hours.

Single chargers and multiple bay chargers are available to recharge the Shure batteries.

Caution: Only charge Shure rechargeable batteries with a Shure battery charger.

Single Bay Charger

The single bay charger offers a compact charging solution.

1. Plug the charger into an AC power source or USB port.
2. Insert a battery into the charging bay.
3. Monitor the charging status LEDs until charging is complete.



Charging Status LED

Color	Status
Red	Charging
Green	Charging Complete
Amber Flashing	Fault: check connections and battery
Off	No battery in bay

Multiple Bay Chargers

Shure offers two models of multiple bay chargers:

- SBC-200 two bay charger
- SBC-800 eight bay charger

Multiple bay chargers can charge individual batteries or batteries installed in transmitters.

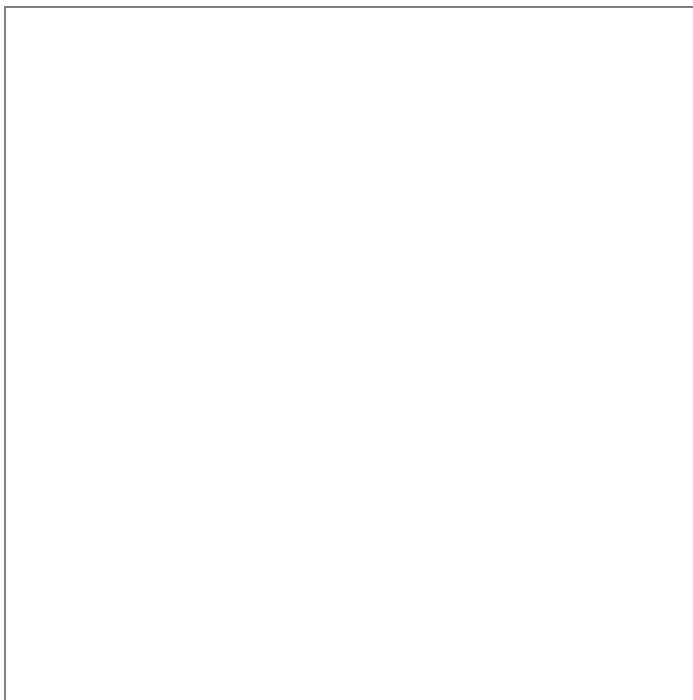

1. Plug the charger into an AC power source.
2. Insert batteries or transmitters into the charging bay.
3. Monitor the charging status LEDs until charging is complete.

Charging Status LED

Color	Status
Green	Charging Complete
Green/Red	Charge level above 90%
Red	Charging
Amber Flashing	Fault: check connections and battery
Off	No battery in bay

Important Tips for Care and Storage of Shure Rechargeable Batteries

Proper care and storage of Shure batteries results in reliable performance and ensures a long lifetime.

- Always store batteries and transmitters at room temperature
- Ideally, batteries should be charged to approximately 40% of capacity for long-term storage
- During storage, check batteries every 6 months and recharge to 40% of capacity as needed

AA Battery Installation

Fully insert the batteries as shown to ensure proper battery contact and to allow the door to latch securely.



Low Battery Alert

The receiver display can be configured to flash when the battery runtime for a transmitter is less than 30 minutes.

The alert displays the following information based on the type of batteries installed in the transmitter:

- SB900 Battery: The receiver screen flashes, the low battery icon is displayed, and the remaining battery runtime is shown
 - AA Batteries: The receiver screen flashes and the low battery icon is displayed
1. Press menu while holding the enter button to access the advanced menu.
 2. Use the arrow buttons to navigate to the Alert screen.
 3. Select On or Off to enable or disable the alert function.
 4. Press the enter button to save.



Receiver Gain Adjustment

The gain control sets the overall signal level for the system. The default gain level is 12 dB and the available gain range is -18 to 42 dB, in 1 dB increments.

Set the gain to a level where the audio LED appears green or yellow, with only the highest audio peaks causing the LED to occasionally turn red and engage the limiter. Reduce the gain if there is audible distortion of the audio.

From the receiver home screen, use the arrow buttons to increase or decrease the gain:

- A single button press adjusts the gain in 1 dB increments
- Press and hold the button for larger adjustments

Test the transmitter at performance levels when adjusting the gain. Monitor the audio meter and the audio LED to prevent overloads.

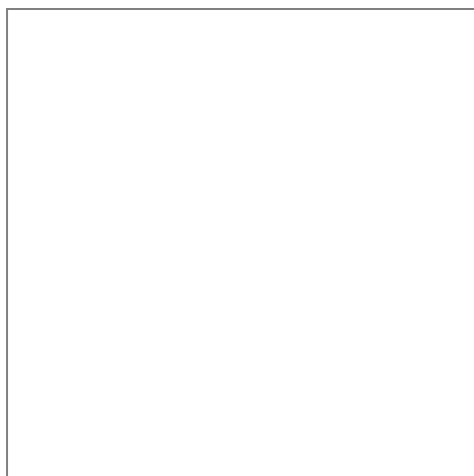

Audio Signal Encryption

The QLX-D receiver features Advanced Encryption Standard (AES-256) to protect the audio signal. When encryption is enabled, the receiver generates a unique encryption key which is shared with a the transmitter during an IR sync. Transmitters and receivers that share an encryption key form a protected audio path, preventing unauthorized access by other receivers. To maintain security, components remain encrypted when turned off and on.

Creating an Encrypted Audio Channel

1. Press the menu button to navigate to the encryption menu, indicated by the key icon.
2. Use the arrow buttons to select an encryption option:
 - on = encryption enabled
 - OFF = encryption disabled
3. Press enter to save. The key icon will be shown on the receiver display.
4. Press the sync button and align the IR sync windows of the transmitter and receiver. The encryption key icon will appear on the transmitter screen when the IR sync is complete and the encryption key has been transferred from the receiver.

Additional transmitters can share the same encryption key with a single receiver. Perform an IR sync to encrypt each additional transmitter.

Note: When OFF is selected to disable encryption, perform an IR sync to clear the encryption key from the transmitter and prevent an encryption mismatch error or FAIL message.

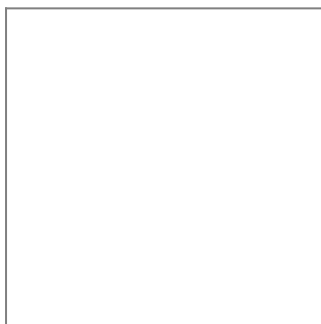

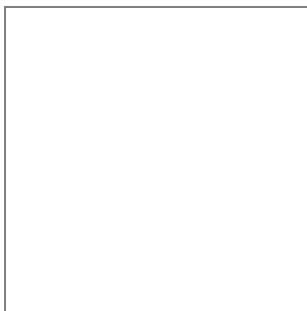

Removing Encryption

1. Press the menu button to navigate to the encryption menu.
2. Select OFF.
3. Press enter to save.
4. IR sync the transmitter and receiver to clear the encryption key from the transmitter and prevent an encryption key mismatch between components, indicated by a FAIL message.

Note: If encryption has been set from off to on, the receiver will generate a new encryption key and must be IR synced to the transmitter to share the new key.

System Set Up

Creating Audio Channels

A wireless audio channel is formed when a receiver and transmitter are tuned to the same frequency. To ease setup, frequencies available to the QLX-D system are organized into channels. Each channel is assigned to a specific preset frequency.

The QLX-D system provides 3 methods for tuning the receiver and transmitter to the same frequency:

- **Scan and IR Sync:** The receiver scans the RF spectrum for the best available frequency and an IR sync automatically tunes the transmitter to the receiver frequency
- **Manual Channel Assignment:** Manually setting the receiver and transmitter to the same channel number forms an audio channel
- **Manual Frequency Assignment:** Manually setting the receiver and transmitter to the same frequency rather than using channels forms an audio channel

Important: Before you begin a scan or frequency assignment:

- **Turn off:** All transmitters for system you are setting up to prevent interference with frequency scans.
- **Turn on:** The following potential sources of interference including other wireless systems, computers, CD players, large LED panels, and effects processors to prevent selection of occupied frequencies.

Scan and IR Sync

The simplest way to create an audio channel is to use the scan function to find the best available receiver channel, and then use the IR sync feature to automatically tune the transmitter to the receiver channel.

Step 1: Scanning to Find the Best Channel

The Scan function automatically selects the best available receiver channel.

1. Navigate to the Scan menu option.

2. Press enter to start the scan.
3. When the scan is complete, the channel will appear on the display.

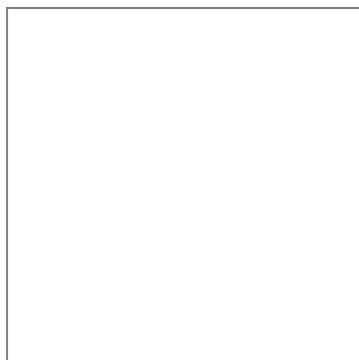

Network Scan

The Network Scan feature automates frequency assignment by using a single receiver to scan and deploy frequencies to all networked receiver within the same frequency band.

Network Scanning and Frequency Deployment

1. Connect receivers to an active Ethernet network. All receivers must be on the same subnet.
2. Prior to performing a network scan, turn on all receivers and allow 60 seconds for all receivers to join the network.
3. Choose a group or custom group for deployment on the receiver that will be used to initiate the network scan.
4. To start a network scan, press the menu button and navigate to the network scan menu. Press enter.
5. When the scan is complete, the displays of receivers waiting for frequencies will flash.
6. Press enter to deploy the frequencies or press menu to cancel the deployment.
7. The front panel LEDs on each receiver will blink when a deployed frequency has been assigned.

Note: Full frequency deployment may not occur if the number of receivers in the network exceeds the number of available frequencies in the selected group. Try another group or rescan after turning off unused receivers.

Step 2: IR Sync for Automatic Transmitter Set Up

Performing an IR Sync automatically tunes the transmitter to match the receiver frequency, forming a wireless audio channel.

1. Turn on the transmitter.
2. Press the sync button on the receiver. The red ir LED will blink indicating that sync mode is active.
3. Align the IR sync windows of the transmitter and receiver at a distance of <15 cm (6 in.). When the transmitter and receiver are aligned, the red ir LED remains on and the sync will automatically occur.
4. sync good appears on the display when IR sync is complete. The blue rf LED will illuminate indicating that the transmitter is within range of the receiver.

Note: If the IR sync fails, repeat the IR sync procedure, carefully maintaining alignment between the IR windows of the transmitter and receiver.



Manual Channel Assignment

An audio channel can be manually created by simply setting the receiver and transmitter to the same channel number. For example, a receiver set channel 3 and a transmitter channel 3 would form an audio channel.

Use manual channel configuration to assign specific channels to receivers and transmitters as an alternative method to automatically creating channels with IR sync.

Use the following steps to set the channel in the receiver and transmitter:

1. Navigate to the channel setting.
2. Use the arrow buttons to scroll through the channels.
3. Press enter to select a channel and save.

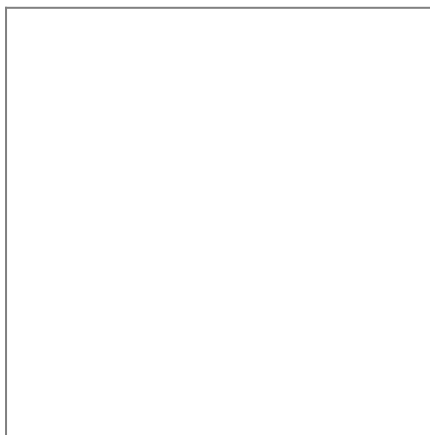

Manual Frequency Selection

Manual frequency selection can be used instead of channels to set the transmitter and receiver to a specific frequency. For example, an audio channel can be created by setting the receiver and transmitter to same frequency.

Setting the Receiver Frequency

1. Press menu to navigate to the frequency setting option.
2. Use the arrow buttons to adjust the frequency. Press and hold for faster scrolling.
3. Press enter to save.

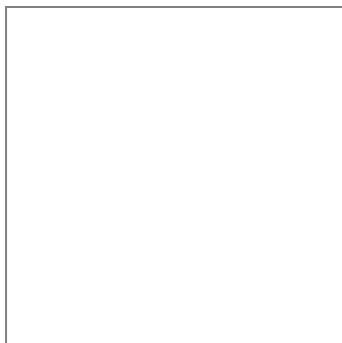

Setting the Transmitter Frequency

1. Press menu to navigate to the frequency setting option.
2. Use the arrow buttons to adjust the frequency. Press and hold for faster scrolling.
3. Press enter to save.

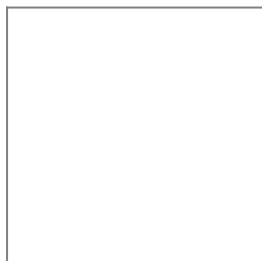

Linking Two Transmitters to a Receiver

Linking two transmitters to a receiver offers the flexibility to provide a performer with either a handheld or bodypack transmitter to meet their preference. For performances requiring instrument changes, two bodypack transmitters can be linked to a single receiver.

Note: Only turn on and operate one transmitter at a time to prevent interference between the transmitters.

Syncing the Transmitters to the Receiver

Both transmitters must be individually linked to the receiver by performing an IR Sync.

1. Turn on the first transmitter and perform an IR Sync with the receiver.
2. Perform a sound check and adjust the transmitter gain if necessary. When finished, turn off the transmitter.
3. Turn on the second transmitter and perform an IR Sync with the receiver.
4. Test the transmitter at performance conditions and adjust the transmitter gain if necessary. When finished, turn off the transmitter.

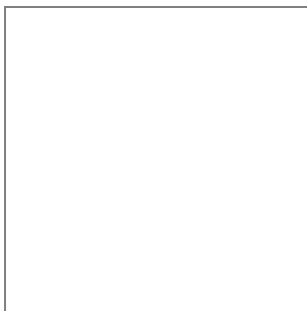

Matching Audio Levels with Mic Offset

When linking two transmitters to a receiver, there may be a difference in volume levels between microphones or instruments. If this occurs, use the Mic Offset function to match the audio levels and eliminate audible volume differences between transmitters. If using a single transmitter, set Mic Offset to 0 dB.

1. Turn on the first transmitter and perform a sound check to test the audio level. Turn off the transmitter when finished.
2. Turn on the second transmitter and perform a sound check to test the audio level.
3. If there is an audible difference in the sound level between the transmitters, navigate to the Mic Offset menu on the transmitter to increase or decrease the Mic Offset in realtime to match the audio levels.



Radio Frequency (RF) Settings

Setting the Transmitter RF Power

The transmitter offers two RF power settings which determine the transmitter range.

- Lo = 1 mW
- Hi = 10 mW

Use the Lo setting when the transmitter and receiver are in close proximity.

1. Navigate to the transmitter rf power menu.
2. Use the arrow buttons to select Hi or Lo.
3. Press enter to save.

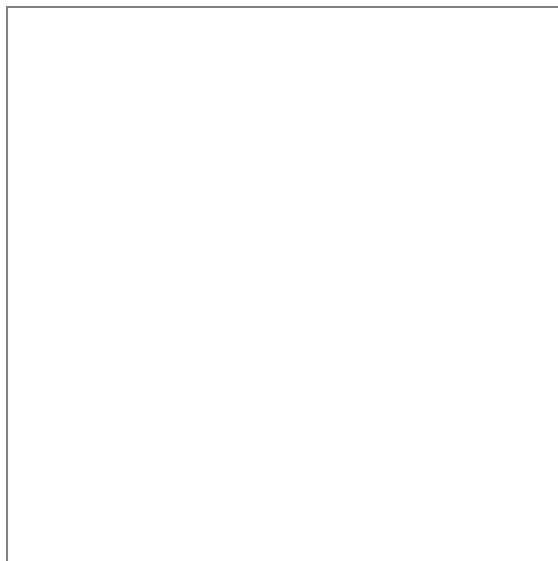

Shure AXT600 Spectrum Manager Compatibility

QLX-D receivers are compatible with the Axient AXT600 Spectrum Manager. Networked receivers will appear in the device inventory and frequencies from the Compatible Frequency List can be deployed and monitored by the Spectrum Manager. For more information regarding the Spectrum Manager, see the Axient System Guide.

Using QLX-D with a Shure ULX-D System

Transmitters and receivers from QLX-D and ULX-D component groups can be paired to form audio channels.

To ensure functionality, use the following settings on receivers and transmitters:

- Encryption set to Off
- High Density Mode set to Off (ULX-D receiver)
- Manually tune the receiver and transmitter to the same frequency.

Note: IR sync between QLX-D and ULXD6/8 transmitters is possible provided you are operating on firmware version 2.1.16 or newer.

To create an audio channel, manually set the receiver frequency to match the frequency of the transmitter.

If using ULXD6 or ULXD8 transmitters with a QLX-D receiver, you can only make changes to transmitter presets using Wireless Workbench.

1. Open receiver properties in WWB.
2. Make changes to transmitter presets and click Apply. The new settings will be sent to the QLX-D receiver.
3. On the receiver front panel, hold enter while pressing menu to enter the advanced menu.
4. Press menu to advance to Preset bn gn. The IR window will flash.

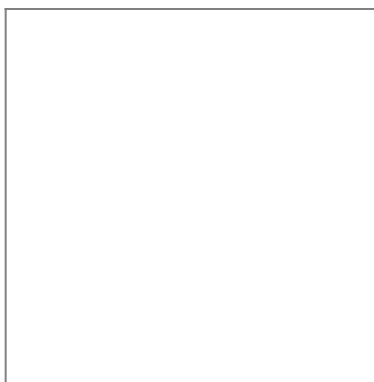

5. Align the transmitter IR window with the receiver to send the presets to the transmitter.

Setting Regional TV Channel Spacing

The parameter for TV channel spacing allows the receiver to match regional TV bandwidth usage and accurately display local TV channels.

The following channel bandwidth options are available:

- 6 MHz
- 7 MHz
- 8 MHz
- 6 JP (Japan)
- off (use to turn off TV channel display)

To set the TV channel spacing:

1. Press and hold the enter button, and then press the menu button to access the advanced features menu.
2. Press the menu button to navigate to the TVCH menu.
3. Use the arrow buttons to select the channel bandwidth that corresponds to the local region.
4. Press enter to save.

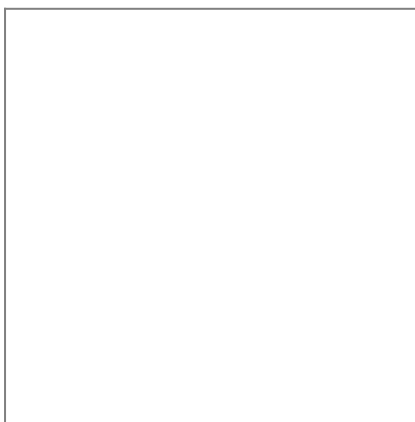

Custom Groups

Specific channels and frequencies can be selected and placed into custom groups. Custom groups are commonly used to assign networked receivers to a specific range of frequencies or to pre-configure receivers for rental applications. Once a custom group has been created, it can be loaded to the receiver using the group menu.

When network scan is used to assign frequencies from a receiver with a custom group selected, all of custom groups (U1, U2, U3, etc...) from that receiver will be loaded to all other receivers on the network.

Creating Custom Groups



Selecting A Custom Group	<p>The receiver has 6 custom groups available named U1, U2, U3, U4, U5, and U6.</p> <ol style="list-style-type: none">1. Press menu while holding the enter button to access the Custom Group screen.2. Press enter to enable editing of a group (indicated by the group flashing).3. Use the arrow buttons to select a group (U1 to U6).4. Press enter to advance to channel selection.
---------------------------------	---

Selecting a Channel	<ol style="list-style-type: none"> 1. Use the arrow buttons to select a channel (1-60). Each group can contain up to 60 channels (frequencies). 2. Press enter to save the selected channel and advance to frequency assignment.
Assigning a Frequency to a Channel	<ol style="list-style-type: none"> 1. Use the arrow buttons to assign a frequency to the selected channel. 2. Press enter to save. <p>After pressing enter, the channel will flash to allow for adding more channels and frequencies to the custom group. To add more channels and frequencies, repeat steps 2 and 3. When finished, press the menu button several times to return to the main menu.</p>

Transmitter IR Sync from a Custom Group

To ensure accurate display of group and channel information, IR sync the transmitter from the Custom Group menu screen:

1. Press menu while holding the enter button to access the Custom Group screen.
2. Turn on the transmitter and press the sync button on the receiver.
3. Align the IR sync windows of the transmitter and receiver.
4. sync good appears on the display when IR sync is complete.

Note: If the IR sync fails, repeat the IR sync procedure, carefully maintaining alignment between the IR windows of the transmitter and receiver.

Deleting a Custom Group

1. Press menu while holding the enter button to access the Custom Group screen.
2. Press enter to enable editing of a group (indicated by the group flashing).
3. Use the arrow buttons to navigate to display the group number and the words DEL.
4. Press enter to delete the group.

To delete individual channels from a custom group, do the following:

1. Enter the custom groups menu and select the frequency for the channel to be deleted.
2. Press and hold an arrow button until the frequency displays ---.--- MHz.
3. Press and hold the menu button to confirm change and exit.

Creating Custom Groups using Wireless Work Bench 6

Custom groups can be created in WWB6 by accessing the Frequency Coordination tab. Refer to the WWB6 help system for detailed instructions for configuring Custom Groups.

Networking

The receiver uses an Ethernet connection to network with other components and includes an internal DHCP client for automatic network configuration when connected to a DHCP enabled router.

Connecting to a Network

1. Insert an Ethernet cable in the Ethernet port on the rear of the receiver.

2. Connect the cable to a computer or router.
3. The port LEDs on the receiver will illuminate to indicate network connectivity and network traffic.

Automatic IP Addressing

1. Enable a DHCP service on the server or use a DHCP enabled router.
2. When the receiver is powered on, the DHCP server will automatically assign an IP address to the receiver.

Tip: Use the network reset option available in the advanced features menu to return the receiver to the default DHCP addressing mode.

Configuration Tips

- Use shielded Cat 5 or better Ethernet cables to ensure reliable network performance
- The LEDs on the Ethernet port illuminate indicating a network connection is active
- The network icon illuminates when the receiver detects additional Shure devices on the network
- All components must operate on the same subnet
- Use multiple Ethernet switches to extend the network for larger installations

Network Troubleshooting

- Use only one DHCP server per network
- All devices must share the same subnet mask
- All receivers must have the same level of firmware revision installed
- Look for the illuminated network icon on the front panel of each device:

If the icon is not illuminated, check the cable connection and the LEDs on the Ethernet port.

If the Ethernet port LEDs are not illuminated and the cable is plugged in, replace the cable and recheck the LEDs and network icon.

To check connectivity of WWB6 to the network:

1. Start WWB6 software and use Inventory view to see devices connected to the network.
2. If not, find the IP address from one of the devices on the network (such as a receiver) and see if you can ping it from the computer running WWB6.
3. From a WINDOWS/MAC command prompt, type 'ping IPADDRESS' of the device (e.g. "ping 192.168.1.100").
4. If the ping returns success (no packet loss), then the computer can communicate with the device on the network. If the ping returns failure (100% packet loss), then verify that the IP address of the computer is on the same subnet as the receiver.
5. If the pings are successful and the devices still do not show up in the WWB6 inventory, check to ensure all firewalls are either disabled or allow the WWB network traffic to pass to the application. Check that firewall settings are not blocking network access.

Setting the IP Address and Subnet Mask Manually

IP addresses and subnet masks can be manually set from the advanced menu in the receiver or from the monitor panel in Wireless Workbench 6.

Network settings entered manually must be valid and conform to IP protocols to ensure proper network communication.

Receiver Menu

IP addresses and subnet addresses contain 4 groups of numbers. Each group can contain up to 3 digits. A decimal point separates each group.

When setting an IP address or subnet address, each of the 4 groups must be edited individually. The following diagram shows how the groups are mapped to the receiver display:

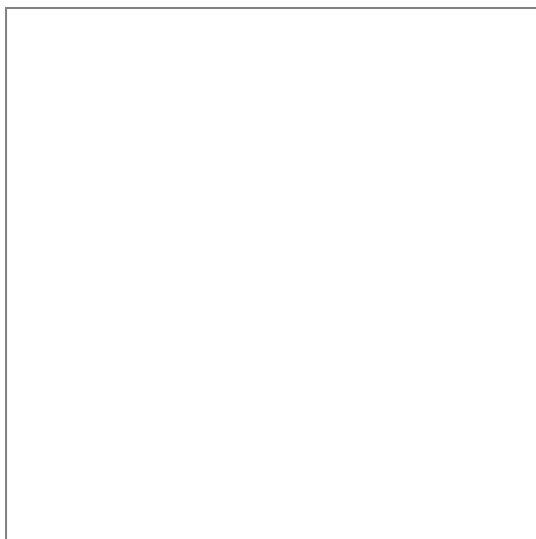

1. Press menu while holding the enter button to access the advanced menu.
2. Press the menu button to navigate to the IP menu.
3. Use the arrow buttons to set the mode to St (static) and press enter.
4. Use the arrow buttons to edit the first group. Press enter to save and continue to the next group.
5. Use the arrow buttons and enter button to edit the remaining 3 groups.
6. When group 4 has been edited, the display will show the subnet mask menu. Use the arrow buttons to scroll and select a preset value for each of the subnet mask groups.
7. When finished, press enter to save settings.

Note: To restore automatic DHCP IP addressing, enter the IP menu and select AU (automatic). The Network Reset menu option can also be used to restore DHCP addressing.

Wireless Workbench 6

1. Open the Channel Properties tab in WWB6.
2. Click on Utilities and set the networking mode to Manual.
3. Enter valid numbers in the IP and Subnet fields.
4. When finished, select Apply.

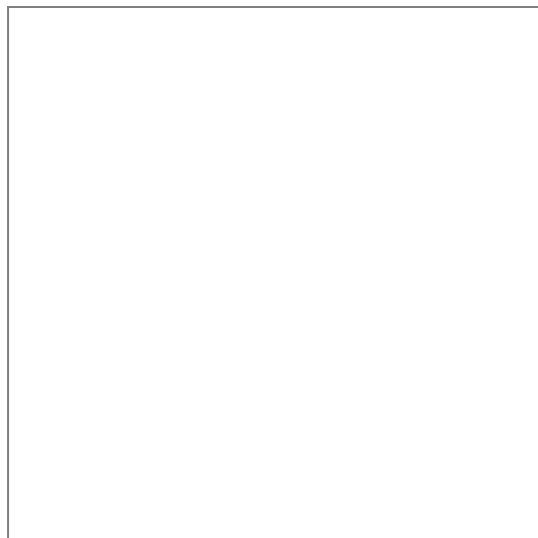

Connecting to an External Control System

The receiver connects to external controls systems (AMX or Crestron) via Ethernet cables.

- Connection: Ethernet (TCP/IP; QLXD receiver is the client)
- Port: 2202

Managing Your System with Shure Software

Wireless Workbench

Manage every facet of wireless system performance, from pre-show planning to live channel monitoring, with Wireless Workbench.

- Visit [the Wireless Workbench page](#) to download Workbench.
- Visit [the Workbench help page](#) to learn how to use Workbench with your system.

ShurePlus Channels Application

Monitor the key elements of your wireless operation on a mobile device over Wi-Fi with ShurePlus Channels. Use alongside Wireless Workbench or as a stand-alone application for less complex coordination needs.

- Visit [the Channels page](#) to download ShurePlus Channels.
- Visit [the Channels user guide](#) to learn how to use Channels with your system.

Firmware Updates

Firmware is embedded software in each component that controls functionality. Periodically, new versions of firmware are developed to incorporate additional features and enhancements.

Firmware Versioning

When updating receiver firmware, update transmitters to the same firmware version to ensure consistent operation.

The firmware version is numbered in the form of MAJOR.MINOR.PATCH (e.g., 1.2.14). At a minimum, all devices on the network (including transmitters), must have the same MAJOR and MINOR firmware version numbers (e.g., 1.2.x).

Downloading and Updating Firmware

A free Shure Update Utility tool is available by visiting www.shure.com. The Shure Update Utility is also bundled with Shure Wireless Workbench software.

Refer to the help instructions to use the Shure Update Utility.

Updating the Receiver

CAUTION! Ensure that receiver power and network connections are maintained during a firmware update. Do not turn off the receiver until the update is complete.

1. Connect the receiver and computer to the same network.
2. Open the Shure Update Utility.
3. Click on the firmware tab to find available updates.
4. Use the Import button if manually importing firmware files.
5. Click the Update Device tab and check the Version to install box next to each device.
6. Click Send Updates to load the firmware to the networked devices.
7. When the download is complete, the receiver will reboot with the updated firmware installed.

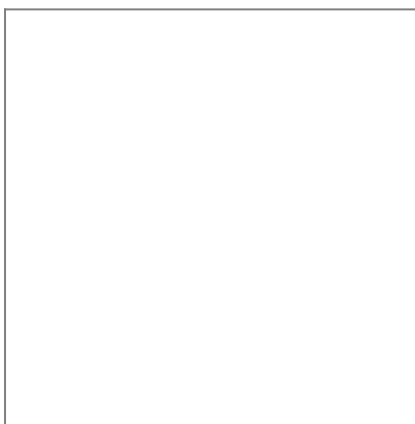

Updating the Transmitter

To update transmitters, download firmware to the receiver. You can download firmware for handheld and bodypack transmitters, or for boundary and gooseneck transmitters. The receiver sends firmware to the transmitter using the IR Sync window.

1. Press menu while holding the enter button to access the advanced menu. Use the menu button to navigate to the update menu.



2. The receiver displays the type of transmitter firmware it has available. The receiver holds one type of firmware at a time.
 - HH BP = handheld or bodypack firmware
 - BN GN = gooseneck or boundary firmware
3. Press enter to start the update.
4. When the red IR LED flashes, align the receiver and transmitter IR sync ports. The red LED will remain illuminated to indicate correct alignment and the download will automatically start.
5. Maintain alignment during the update and monitor download progress (0 to 100%) on the receiver screen.

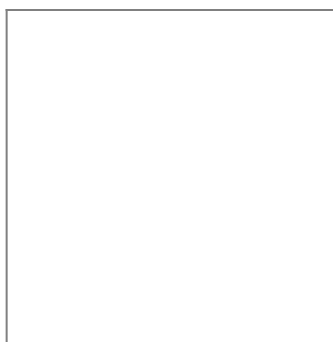

6. When the update is complete, "TX Update good" is shown on the receiver display. If the screen shows Err. 09, update again with a transmitter type that matches the firmware held by the receiver.

Troubleshooting

Issue	See Solution...
No Sound	Power, Cables, or Radio Frequency
Faint sound or distortion	Gain, Cables, Reducing Interference or Radio Frequency
Lack of range, unwanted noise bursts, or dropouts	RF
Cannot turn transmitter off or change frequency settings, or can't program receiver	Interface Locks
Receiver display shows FAIL after encryption is disable	Encryption Mismatch
Group and Channel display shows "--"	Custom Group IR Sync

Power

Make sure that the receiver and transmitter are receiving sufficient voltage. Check the battery indicators. Replace or recharge the batteries if necessary.

Gain

Adjust the system gain on the front of the receiver. Ensure the mic/line switch setting (XLR output only) on the back of the receiver corresponds to the input of the mixing console, amplifier, or processor.

Cables

Check that all cables and connectors are fully engaged or locked into position. Inspect cables for damage. Replace if necessary.

Interface Locks

The transmitter and the receiver can be locked to prevent accidental or unauthorized changes. If a locked control is accessed, the lock icon on the display will flash. Follow the instructions to unlock the receiver or transmitter.

Firmware Mismatch

Paired transmitters and receivers must have the same firmware version installed to ensure consistent operation. See Firmware Updates topic for firmware update procedure.

Encryption Mismatch

Indicates an encryption key mismatch has been detected. Perform an IR sync between the receiver and transmitter to clear the error.

Custom Group IR Sync

When using Custom Groups, always perform an IR sync from the Custom Groups menu in the receiver to ensure accurate display of group and channel information. See Custom Groups topic for additional details.

Radio Frequency (RF)

The blue RF LED will illuminate when a linked transmitter is within range of the receiver. Measure the transmitter range before a performance to avoid operating beyond the specified transmitter range.

The RF meter bars indicate amount of RF power being received. This signal could be from the transmitter, **or it could be from an interfering source, such as a television broadcast.** If the meter shows a signal level when the transmitter is off, then that channel may have interference. Check the surrounding area for sources of interference or change the receiver to a clear frequency.

A red RF LED indicates RF overload. Avoid operating multiple systems in close proximity.

Frequency Compatibility

- Perform a Scan and Sync to ensure the transmitter and receiver are set to the same channel or frequency
- Look at the label on the transmitter and receiver to make sure they are in the same band (G50, J50, L50, etc...).

Reducing Interference

- Perform a scan to find the best open frequency. Perform an IR sync to transfer the settings to the transmitter.

- For multiple systems, make sure that each receiver is assigned to a unique channel. Interference will occur if two transmitters are set to the same channel.
- Maintain a line of sight between transmitter and receiver antennas.
- Move receiver antennas away from metal objects or other sources of RF interference (such as CD players, computers, digital effects, network switches, network cables and Personal Stereo Monitor (PSM) wireless systems).
- Eliminate RF overload (see below).

Increasing Range

- Increase transmitter RF power level to Hi
- Use an active directional antenna, antenna distribution system, or other antenna accessory to increase RF range

Eliminating RF Overload

If the RF OL icon appears on the RF meter, try the following:

- Reduce the transmitter RF power level from Hi to Lo
- Move the transmitter further away from the receiver—at least 6 m (20 ft)
- If you are using active antennas, reduce antenna or amplifier gain.
- Use omnidirectional antennas

Error Codes and Solutions

Error codes are generated when the receiver detects a condition that can potentially affect system performance.

If an error is displayed on the receiver, use the following table to identify the problem and find the corresponding solution.

Error Code	Description	Solutions
Err.001	Audio Compatibility	Update transmitter and receiver firmware to the latest version.
Err.002	Encryption Mismatch between Shure product lines	Set encryption to off for components from different Shure products lines, such as QLX-D and ULX-D.
Err.003	Encryption Mode Mismatch	Perform an IR sync between the transmitter and receiver to clear the error.
Err.004	Band Mismatch	Receiver and transmitter are operating in overlapping frequencies from different bands.
Err.005	Frequency Mismatch	Receiver and transmitter are from bands that do not share compatible frequencies.
Err.006	No Frequencies Found	Rescan or use WWB to find a frequency.
Err.007	Firmware Version Self-Test Failed	Use the Shure Update Utility to update the unit to the latest firmware. If the error persists, contact Shure Support.
Err.008	Shure SB900 battery runtime does not appear on display	Check that battery is firmly installed into the battery compartment. If condition persists, replace the battery.
Err.009	Transmitter Type Mismatch	To complete the firmware update, match the type of transmitter to the type of firmware the receiver currently has. HH BP = handheld or bodypack firmware BN GN = gooseneck or boundary firmware

Single and Dual Rackmount Assembly



Securing the AC Power Cord

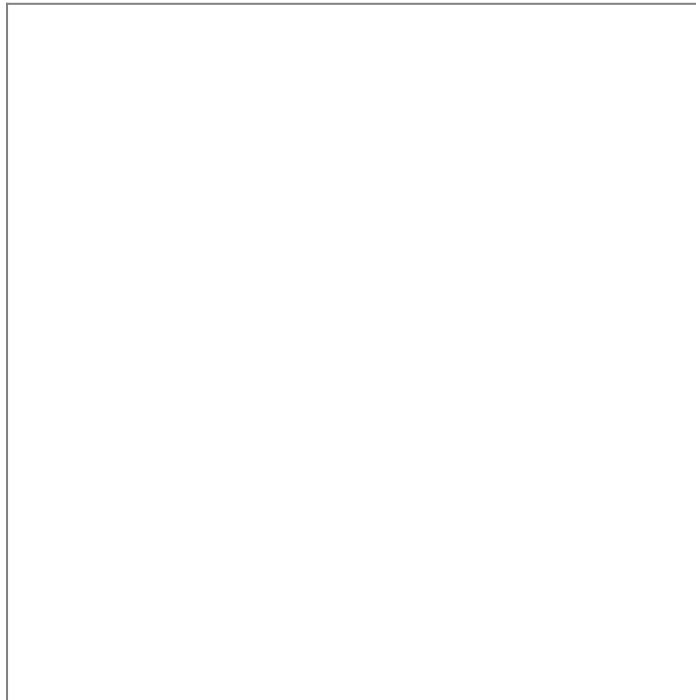

Installing Footpads

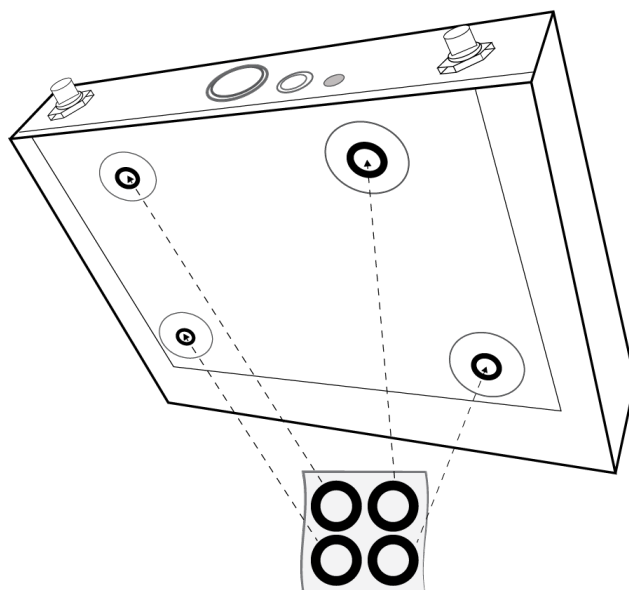

Accessories

Optional Accessories

Batteries and Chargers

Shure Lithium-Ion Rechargeable Battery	SB900
8-Bay Shure Battery Charger	SBC800-US
Dual Docking Charger With PS45US Power Supply	SBC200-US
Dual Docking Charger, Power Supply Not Included	SBC200
2-Bay networked docking charger	SBC220
Single Battery Charger	SBC100
SBRC charging module	SBC-AX
2-Bay Portable Battery Charger With PS50US Power Supply	SBC210
Bodypack Power Insert	SBC-DC

UHF Antenna Power Distribution Amplifiers

UHF Wideband Antenna Distributor w/o Power Cables	UA844SWB/LC
UHF Antenna Power Distribution System	UA844SWB/LC-AR
UHF Antenna Power Distribution System	UA844SWB/LC-BR
UHF Antenna Power Distribution System	UA844SWB/LC-AZ
UHF Antenna Power Distribution System	UA844SWB/LC-C
UHF Antenna Power Distribution System	UA844SWB/LC-E
UHF Antenna Power Distribution Amplifier	UA844SWB/LC-J
UHF Antenna Power Distribution Amplifier	UA844SWB/LC-K
UHF Antenna Power Distribution Amplifier	UA844SWB/LC-UK

UABIAST

In-Line Power Supply	UABIAST-US
	UABIAST-UK
	UABIAST-BR
	UABIAST-AR

	UABIAST-E
	UABIAST-CHN
	UABIAST-K
	UABIAST-J
	UABIAST-AZ
	UABIAST-TW

In-Line Amplifiers and Antennas

In-Line Antenna Amplifier, 174-216 MHz	UA834V
In-Line Antenna Amplifier, 470-902 MHz	UA834WB
In-Line Antenna Amplifier, 902-960 MHz	UA834XA
Active Directional Antenna 470-790MHZ	UA874E
Active Directional Antenna 470-698MHZ	UA874US
Active Directional Antenna 470-900MHZ	UA874WB
Active Directional Antenna 925-952MHZ	UA874X
Directional Wideband Antenna for PSM Systems	PA805SWB
Directional Wideband Antenna for PSM Systems	PA805X
Passive Omnidirectional Antenna	UA860SWB
UHF Passive Antenna Splitter	UA221
Front Mount Antenna Kit (Includes 2 Cables And 2 Bulkhead)	UA600
Remote Antenna Bracket With BNC Bulkhead Adaptor	UA505
Helical Antenna, 470-900MHZ	HA-8089
Helical Antenna, 944-952MHZ	HA-8241

Cables and Connectors

Coaxial Cable, BNC-BNC, RG58C/U TYPE, 50 OHM, 2 FT Length (0.6 M)	UA802
Coaxial Cable, BNC-BNC, RG58C/U TYPE, 50 OHM, 6 FT Length (2 M)	UA806
Coaxial Cable, BNC-BNC, RG8X/U TYPE, 50 OHM, 25 FT Length (7.5 M)	UA825

Coaxial Cable, BNC-BNC, RG8X/U TYPE, 50 OHM, 50 FT Length (15 M)	UA850
Coaxial Cable, BNC-BNC, RG213/U TYPE, 50 OHM, 100 FT Length (30 M)	UA8100
Ethernet Jumper Cable, 8"	C8006
Ethernet Cable, 3 FT.	C803
Ethernet Cable, 10 FT.	C810
Ethernet Cable, Ruggedized, 100 FT.	C8100
Ethernet Cable, Ruggedized, 25 FT.	C825
Ethernet Cable, Ruggedized, 50 FT.	C850

1/2 Wave Omnidirectional Receiver Antennas

470-542 MHz	UA8-470-542
500-560 MHz	UA8-500-560
518-598 MHz	UA8-518-598
554-638 MHz	UA8-554-638
596-698 MHz	UA8-596-698
670-742 MHz	UA8-670-742
690-746 MHz	UA8-690-746
694-758 MHz	UA8-694-758
710-790 MHz	UA8-710-790
740-814 MHz	UA8-740-814
750-822 MHz	UA8-750-822
774-865 MHz	UA8-774-865
00-1000 MHz	UA8-900-1000

Hardware, Cases, and Accessories

Hard Carrying Case For SLX System	WA610
Mute Switch for Shure Handheld Transmitters	UAMS/BK
Cable, Instrument, 2.5 foot (.75 m), 4 Pin Mini Connector (TA4F) to 1/4-inch Connector.	WA302

Cable, Instrument, 2-foot (0.7m), 4-pin Mini Connector (TA4F) with Right-Angle 1/4-inch Connector, used with Shure Wireless Bodypack Transmitters	WA304
Premium Guitar Cable TQG Threaded Connector	WA305
Premium Guitar Cable TQG Latching Connector	WA306
Cable, Microphone, 4-foot (1.3m), 4-pin Mini Connector (TA4F) to XLR Connector (F), used with Shure Bodypack Transmitters.	WA310
In-line audio mute switch for Shure wireless bodypack transmitters with a TA4F connector.	WA360
In-Line Bodypack Mute Switch	WA661
Securely mounts the Shure wireless handheld transmitters to standard microphone stands.	WA371
Neoprene bodypack arm pouch for all Shure bodypack transmitters	WA620

Hardware, Cases, and Accessories

Carrying Case	WA610
Anti-Roll Device for all Handheld Microphones	A1K
Mute Switch for Shure Handheld Transmitters	UAMS/BK
Cable, Instrument, 2.5 foot (.75 m), 4 Pin Mini Connector (TA4F) to 1/4-inch Connector.	WA302
Cable, Instrument, 2-foot (0.7m), 4-pin Mini Connector (TA4F) with Right-Angle 1/4-inch Connector, used with Shure Wireless Bodypack Transmitters	WA304
Premium Guitar Cable TQG Threaded Connector	WA305
Premium Guitar Cable TQG Latching Connector	WA306
Cable, Microphone, 4-foot (1.3m), 4-pin Mini Connector (TA4F) to XLR Connector (F), used with Shure Bodypack Transmitters.	WA310
In-Line On/Off Switch	WA360
In-Line Bodypack Mute Switch	WA661
Wireless Microphone Clip	WA371
Neoprene bodypack arm pouch for all Shure bodypack transmitters	WA620

Cables and Connectors

2 ft. BNC-BNC Coaxial Cable	UA802
------------------------------------	-------

6 foot (1.8m) BNC to BNC Coaxial Cable for Remote Antenna Mounting for ULX Wireless System	UA806
25 ft. BNC-BNC Coaxial Cable	UA825
50 ft. BNC-BNC Coaxial Cable	UA850
100 ft. BNC-BNC Coaxial Cable	UA8100
Ethernet Jumper Cable, 8"	C8006
Ethernet Cable, 3'	C803
Ethernet Cable, 10'	C810
Ethernet Cable, Ruggedized 100'	C8100
Ethernet Cable, Ruggedized 25'	C825
Ethernet Cable, Ruggedized 50'	C850

In-Line Amplifiers and Antennas

In-Line Antenna Amplifier, 792-810 MHz	UA830A
In-Line Antenna Amplifier, 470-698MHz	UA830USTV
In-Line Antenna Amplifier, 500-900 MHz	UA830WB
In-Line Antenna Amplifier	UA830X
Active Directional Antenna 470-790MHz	UA874E
Active Directional Antenna 470-698MHz	UA874US
Active Directional Antenna 470-900MHz	UA874WB
Active Directional Antenna 925-952MHz	UA874X
Passive Directional Antenna 470-952 MHz. Includes 10 foot BNC to BNC cable.	PA805SWB
Passive Directional Antenna 944-952 MHz	PA805X
Wideband Omnidirectional Antenna (470-1100 MHz)	UA860SWB
Passive Antenna/Splitter Combiner Kit (recommended for 2 receivers)	UA221
Front Mount Antenna Kit (Includes 2 Cables And 2 Bulkhead)	UA600
1/2 Wave Antenna Remote Mount Kit	UA505
PWS Helical Antenna, 480-900 MHz	HA-8089
Helical Antenna, 944-954 MHz	HA-8241

UHF Antenna Power Distribution Amplifiers

UHF Wideband Antenna Distributor w/o Power Cables	UA844SWB/LC
UHF Antenna Power Distribution System	UA844SWB/LC-AR
UHF Antenna Power Distribution System	UA844SWB/LC-BR
UHF Antenna Power Distribution System	UA844SWB/LC-AZ
UHF Antenna Power Distribution System	UA844SWB/LC-C
UHF Antenna Power Distribution System	UA844SWB/LC-E
UHF Antenna Power Distribution Amplifier	UA844SWB/LC-J
UHF Antenna Power Distribution Amplifier	UA844SWB/LC-K
UHF Antenna Power Distribution Amplifier	UA844SWB/LC-UK

Active Antenna Splitters

Antenna Distribution System	UA845 E
Antenna Distribution System	UA845 E "B"
Antenna Distribution System	UA845J
Antenna UHF-R 470-952 MHz	UA845-SWB
Antenna,Power Dist UHF-R 470-952 MHz	UA845-SWB-AZ
Antenna UHF-R 470-952 MHz	UA845-SWB-BR
Antenna,Power Dist UHF-R 470-952 MHz	UA845-SWB-C
Antenna,Power Dist UHF -R 470-952 MHz	UA845-SWB-E
Antenna UHF-R 470-952 MHz	UA845-SWB-K
Antenna, Power Dist UHF-R 470-952 MHz	UA845US

Batteries and Chargers

Shure Lithium-Ion Rechargeable Battery	SB900
8 Pack Shure Lithium-Ion Rechargeable Batteries	SB900-8
8-Bay Shure Battery Charger	SBC800-US
Dual Docking Charger With PS45US Power Supply	SBC200-US
Dual Docking Charger, Power Supply Not Included	SBC200
Single Battery Charger	SBC100
Axient Charging Module	SBC-AX

2-Bay Portable Battery Charger With PS50US Power Supply	SBC210
Power a SB900-compatible bodypack with an AC power supply instead of batteries	SBC-DC
Black Bodypack Pouch	WA582B

Specifications

RF Carrier Frequency Range

470–937.5 MHz, varies by region (See Frequency Range and Output Power table)

Working Range

100 m (328 ft)

RF Tuning Step Size

25 kHz, varies by region

Image Rejection

>70 dB, typical

RF Sensitivity

-97 dBm at 10^{-5} BER

Latency

<2.9 ms

Audio Frequency Response

QLXD1	20 – 20 kHz (± 1 dB)
QLXD2	Note: Dependent on microphone type

Audio Dynamic Range

System Gain @ +10

>120 dB, A-weighted, typical

Total Harmonic Distortion

-12 dBFS input, System Gain @ +10

<0.1%

System Audio Polarity

Positive pressure on microphone diaphragm produces positive voltage on pin 2 (with respect to pin 3 of XLR output) and the tip of the 6.35 mm (1/4-inch) output.

Operating Temperature Range

-18°C (0°F) to 50°C (122°F)

Storage Temperature Range

-29°C (-20°F) to 74°C (165°F)

Battery Life

QLXD	SB900A 1/10 mW	alkaline 1/10 mW
470 to 865	>9:30 hours	8 hours
902 to 928	>8:30 hours	>6 hours
174 to 216	>9:30 hours	>8:30 hours
1240 to 1800	>8:00 hours	>6 hours

The values in this table are typical of fresh, high quality batteries. Battery runtime varies depending on the manufacturer and age of the battery.

QLXD4

Dimensions

41 mm x 197 mm x 151 mm (1.63 in. x 7.75 in. x 5.94 in.), H x W x D

Weight

777 g (1.71 lbs), without antennas

Housing

steel

Power Requirements

12 V DC @ 0.4 A, supplied by external power supply (tip positive)

RF Input

Spurious Rejection

>80 dB, typical

Connector Type

BNC

Impedance

50 Ω

Audio Output

Gain Adjustment Range

-18 to +42 dB in 1 dB steps

Configuration

1/4" (6.35 mm)	Impedance balanced (Tip=audio, Ring=no audio, Sleeve=ground)
XLR	balanced (1=ground, 2=audio +, 3=audio -)

Impedance

1/4" (6.35 mm)	100 Ω (50 Ω Unbalanced)
XLR	100 Ω

Full Scale Output

1/4" (6.35 mm)	+12 dBV
XLR	LINE setting= +18 dBV, MIC setting= -12 dBV

Mic/Line Switch

30 dB pad

Phantom Power Protection

1/4" (6.35 mm)	Yes
XLR	Yes

Networking

Network Interface

Single Port Ethernet 10/100 Mbps

Network Addressing Capability

DHCP or Manual IP address

Maximum Cable Length

100 m (328 ft)

QLXD1

Mic Offset Range

0 to 21 dB (in 3 dB steps)

Battery Type

Shure SB900 Rechargeable Li-Ion or AA batteries 1.5 V

Dimensions

86 mm x 65 mm x 23 mm (3.38in. x 2.57 in. x 0.92 in.) H x W x D , without antenna

Weight

138 g (4.9 oz.), without batteries

Housing

Cast aluminum

Audio Input

Connector

4-Pin male mini connector (TA4M), See drawing for details

Configuration

Unbalanced

Impedance

1 M Ω , See drawing for details

Maximum Input Level

1 kHz at 1% THD

8.5 dBV (7.5 Vpp)

Preamplifier Equivalent Input Noise (EIN)

System Gain Setting $\geq +20$

-120 dBV, A-weighted, typical

RF Output

Connector

SMA

Antenna Type

1/4 wave

Impedance

50 Ω

Occupied Bandwidth

<200 kHz

Modulation Type

Shure proprietary digital

Power

1 mW or 10 mW

QLXD2

Mic Offset Range

0 to 21 dB (in 3 dB steps)

Battery Type

Shure SB900 Rechargeable Li-Ion or AA batteries 1.5 V

Dimensions

269 mm x 51 mm (10.6 in. x 2.0 in.) L x Dia.

Weight

307 g (12.1 oz.), without batteries

Housing

Machined aluminum

Audio Input

Configuration

Unbalanced

Maximum Input Level

1 kHz at 1% THD

145 dB SPL (SM58), typical

RF Output

Antenna Type

Integrated Single Band Helical

Occupied Bandwidth

<200 kHz

Modulation Type

Shure proprietary digital

Power

1 mW or 10 mW

Receiver Output Connectors

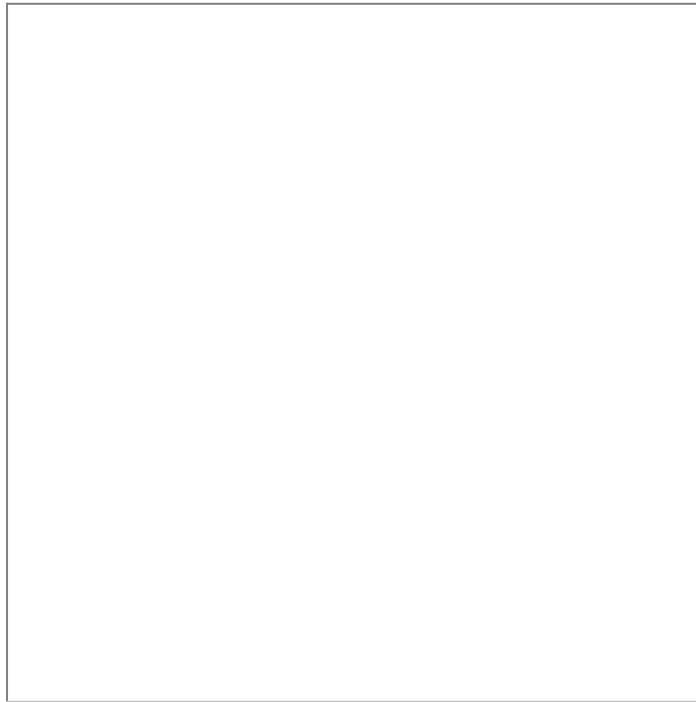

TA4M Input Connector Diagram



①	Ground
②	Bias Voltage
③	Audio Input
④	Ground

Frequency Range and Transmitter Output Power

Band	Frequency Range (MHz)	Power (mW RMS)* (Lo/Nm/Hi)
G50	470 to 534	1 / 10
G51	470 to 534	1 / 10
G52	479 to 534	1 / 10
G62	510 to 530	1 / 10
H50	534 to 598	1 / 10
H51	534 to 598	1 / 10
H52	534 to 565	1 / 10
H53	534 to 598	1 / 10
J50	572 to 636	1 / 10
J51	572 to 636	1 / 10
JB	806 to 810	1 / 10
K51	606 to 670	1 / 10
K52	606 to 670	1 / 10
L50	632 to 696	1 / 10
L51	632 to 696	1 / 10
L52	632 to 694	1 / 10
L53	632 to 714	1 / 10
M19	694 to 703 (Thailand)	1 / 10
P51	710 to 782	1 / 10
P52	710 to 782	1 / 10
Q12	748 to 758 (Thailand)	1 / 10
Q51	794 to 806	10
S50	823 to 832, 863 to 865	1 / 10
V50	174 to 216	1 / 10
V51	174 to 216	1 / 10
V52	174 to 210	10
X51	925 -937.5	1 / 10

Band	Frequency Range (MHz)	Power (mW RMS)* (Lo/Nm/Hi)
X52	902 to 928 (All Americas except Brazil)	1 / 10
X53	902 to 907.500, 915 to 928 (Brazil)	1 / 10
X54	915 to 928 (Australia)	1 / 10
Z17	1492 to 1525	1 / 10
Z18	1785 to 1805	1 / 10
Z19	1785 to 1800	1 / 10
Z20	1790 to 1805	1 / 10

* Power delivered to the antenna port

Note: Frequency bands might not be available for sale or authorized for use in all countries or regions.

For the band Z17 (1492-1525 MHz), it must be used indoors only.

For the Band Z19 (1785-1800MHz) used in Australia, per Radio Communications Low Interference Potential Devices Class License 2015; item 30 note C: the system must be operated within the range of 1790-1800MHz when used outdoors.

低功率電波輻射性電機管理辦法

第十二條

經型式認證合格之低功率射頻電機，非經許可，公司、商號或使用者均不得擅自變更頻率、加大功率或變更原設計之特性及功能。第十四條

低功率射頻電機之使用不得影響飛航安全及干擾合法通信；經發現有干擾現象時，應立即停用，並改善至無干擾時方得繼續使用。前項合法通信，指依電信法規定作業之無線電通信。低功率射頻電機須忍受合法通信或工業、科學及醫療用電波輻射性電機設備之干擾。

เครื่องโทรคมนาคมและอุปกรณ์นี้มีความสอดคล้องตามมาตรฐานหรือข้อกำหนดทางเทคนิคของ กสทช.

Certifications

This device contains licence-exempt transmitter(s)/receiver(s) that comply with Innovation, Science and Economic Development Canada's licence-exempt RSS(s). Operation is subject to the following two conditions:

1. This device may not cause interference.
2. This device must accept any interference, including interference that may cause undesired operation of the device.

L'émetteur/récepteur exempt de licence contenu dans le présent appareil est conforme aux CNR d'Innovation, Sciences et Développement économique Canada applicables aux appareils radio exempts de licence. L'exploitation est autorisée aux deux conditions suivantes :

1. L'appareil ne doit pas produire de brouillage;
2. L'appareil doit accepter tout brouillage radioélectrique subi, même si le brouillage est susceptible d'en compromettre le fonctionnement.

QLXD1, QLXD2, QLXD4

Meets essential requirements of the following European Directives:

- WEEE Directive 2012/19/EU, as amended by 2008/34/EC
- RoHS Directive EU 2015/863

Note: Please follow your regional recycling scheme for batteries and electronic waste

Hereby, Shure Incorporated declares that the radio equipment is in compliance with Directive 2014/53/EU. The full text of the EU declaration of conformity is available at the following internet address: <http://www.shure.com/europe/compliance>

Authorized European representative:

Shure Europe GmbH

Headquarters Europe, Middle East & Africa

Department: EMEA Approval

Jakob-Dieffenbacher-Str. 12

75031 Eppingen, Germany

Phone: +49-7262-92 49 0

Fax: +49-7262-92 49 11 4

Email: EMEAsupport@shure.de

Industry Canada ICES-003 Compliance Label: CAN ICES-3 (B)/NMB-3(B)

QLXD1, QLXD2

Certified under FCC Part 74.

Certified by ISED in Canada under RSS-102 and RSS-210.

IC: 616A-QLXD1G50, 616A-QLXD1H50, 616A-QLXD1J50, 616A-QLXD1L50, 616A-QLXD2G50, 616A-QLXD2H50, 616A-QLXD2J50, 616A-QLXD2L50.

FCC: DD4QLXD1G50, DD4QLXD1H50, DD4QLXD1J50, DD4QLXD1L50, DD4QLXD2G50, DD4QLXD2H50, DD4QLXD2J50, DD4QLXD2L50.

IC: 616A-QLXD1X52, 616A-QLXD2X52

FCC: DD4QLXD1X52, DD4QLXD2X52

IC: 616A-QLXD1V50, 616A-QLXD2V50

FCC: DD4QLXD1V50, DD4QLXD2V50

Note: For transmitters operating in the V50 and V51 bands: nominal free space antenna gain at middle of the band is typically -6 dBi, and rolls off at the band edges an additional -4 dB.

QLXD4

Approved under the Declaration of Conformity (DoC) provision of FCC Part 15.

Conforms to electrical safety requirements based on IEC 60065.