

TASCAM

D01238020E

DR-44WL

Linear PCM Recorder

REFERENCE MANUAL



Contents

1 – Introduction	4	Set the low-cut filter.....	22
Features	4	Using the level control function	23
Conventions used in this manual.....	4	Record in 4CH mode (4CH mode only)	23
About SD cards.....	5	Record 4 channels.....	23
Precautions.....	5	File names when recording in 4-channel	23
Trademarks and copyrights.....	5	Record in MTR mode (MTR mode only).....	24
2 – Names and functions of parts	6	Switch files during recording (track increment, available in 4CH mode only)	24
Top panel.....	6	Manual track increment during recording.....	24
Front panel	7	Automatic track increment at specified time.....	24
Left side panel	7	Recording automatically (AUTO REC) (4CH mode only).....	25
Right side panel	7	Start recording a moment before pressing RECORD (PRE REC, 4CH mode only)	25
Bottom panel.....	8	Self-timer function.....	26
Home Screen.....	8	Simultaneously recording two files with different input levels/formats (DUAL REC, 4CH only)	26
Recording Screen	9	Enabling dual recording	26
Menu item list.....	10	Starting dual recording.....	27
Using menus	11	Dual recording file names.....	27
Basic operations.....	11	Create cue marks during recording.....	27
3 – Preparation.....	12	Manual cue marking during recording	27
Powering the unit.....	12	Add cue marks automatically during recording	28
Power sources.....	12	Moving to the cue mark position.....	28
Using AA size batteries.....	12	Use MS microphone	29
Using an AC adapter	12	Punching in/out (MTR mode only).....	29
Changing the outlet plug	12	Punching in/out manually.....	29
Using an external battery pack (sold separately)	13	Punching in/out automatically (AUTO PUNCH)	29
Using USB bus power	13	Recording duration.....	31
Turning the power on and off (standby mode).....	13	5 – Operating Files and Folders (4CH Mode Only)	32
Starting up the unit.....	13	Screen navigation	32
Shutting down (standby mode)	13	Icons on the BROWSE screen	32
Resume function	14	File operations.....	32
Selecting the language.....	14	Folder operations	33
If you accidentally select the wrong language.....	14	Creating a new folder	34
Setting the date/time	14	6 – Managing Songs (MTR Mode only).....	35
Inserting and removing SD cards.....	14	Song Operation.....	35
Inserting the SD card	14	Loading Songs.....	35
Removing the card	15	Creating a New Song	36
SD card write protection switches	15	Changing the Song Name.....	36
Preparing an SD card for use.....	15	Deleting songs	37
Turning the built-in speaker on/off	15	7 – Playback	38
Connecting a monitor device.....	15	Playback.....	38
Adjusting the playback volume.....	16	Pausing.....	38
Input settings.....	16	Stopping.....	38
Recording with the built-in microphone.....	16	Fast-rewinding and fast-forwarding (search).....	38
Recording with an external microphone (EXT MIC IN)	16	Moving the playback position.....	38
Recording from an external device (LINE IN)	16	Selecting a playback file (skip)	38
Selecting Operation Mode.....	17	Special Playback Control Functions.....	38
Setting a mode.....	17	Playback Control Screen	38
Checking mode.....	17	Repeated Playback of Selection (Loop Playback).....	39
Attaching the grip.....	17	Clearing IN and OUT points only	39
Attaching the shoe mount adapter	17	Changing the playback speed (VSA).....	39
4 – Recording	18	Key control playback.....	40
Overview of recording modes.....	18	Adding marks manually during playback	40
Set where to save the file	18	Clearing specified marks	40
Select the file format and sampling frequency (4CH mode only)	18	Setting the mark skip mode.....	40
Adjusting the input level.....	19	8 – QUICK Button Operation	41
Set the input gain.....	19	QUICK button overview	41
Using phantom power	19	Quick menu operation	41
Settings in the INPUT SETTING screen.....	20	Closing the Quick menu	42
Setting channel links (4CH mode only).....	21		
Set the track input (MTR mode only)	21		
DELAY setting	22		

Deleting the selected file (Quick Delete, only when in 4CH mode)	43	Auto power save function setting.....	61
Dividing the selected file (4CH mode only).....	43	Battery type settings.....	61
Dividing the selected file manually(DIVIDE)	43	Set the voltage value of the phantom power supply	61
Dividing the selected file automatically (AUTO DIVIDE) ...	44	Backlight setting.....	61
Deleting track input (MTR mode only).....	44	Adjusting the display contrast	61
Track bounce (MTR mode only)	45	Set the peak hold	61
Bouncing tracks	45		
Confirming the results of bouncing	45	14 – Messages	62
Mixing down	46	15 – Troubleshooting	63
Loading master tracks (MTR mode only)	46	16 – Specifications	64
9 – Mixer	47	Rating	64
Setting the mixer.....	47	Input/output ratings	64
Analog audio input and output ratings.....	64	Control input/output ratings.....	64
10 – Useful functions	48	Audio performance	64
Tuner function.....	48	Wi-Fi	64
Chromatic tuner.....	48	General.....	65
Oscillator mode.....	48	Dimensional drawings.....	65
Metronome function	49		
Reverb function	49		
Setting the reverb function	49		
Reverb type pre-set list	50		
Setting the XRI information recording function (4CH mode only)	50		
Viewing XRI information (4CH mode only)	50		
Deleting XRI information (4CH mode only)	50		
11 – Connecting with a computer	52		
Transferring files to a computer.....	52		
Transferring files from a computer	52		
Disconnecting the unit from a computer.....	52		
12 – Using Wi-Fi.....	53		
Connect the unit and smart phone via Wi-Fi	53		
How to download and install the exclusive application (DR CONTROL)	53		
Selecting the Wi-Fi mode	53		
Connecting the unit directly to external devices (smart-phones, tablets and computers) by Wi-Fi (TO DEVICE mode)	53		
Connecting the unit to external devices (smartphones, tablets and computers) by Wi-Fi (VIA ROUTER mode).....	55		
Launching DR CONTROL	56		
Connecting this unit to a computer by Wi-Fi	57		
Downloading and installing the TASCAM DR FILE TRANSFER software	57		
Connecting the unit directly to a computer by Wi-Fi (TO DEVICE mode)	57		
Connecting this unit to a computer by Wi-Fi after the first time	58		
13 – Settings and Information	59		
View information (INFORMATION)	59		
Project information page 1 (PROJECT 1/2) (4CH mode only)	59		
Project information page 2 (PROJECT 2/2) (4CH mode only)	59		
Card information page (CARD).....	59		
System information page (SYSTEM)	59		
Configuration (SYSTEM).....	60		
Setting the file name type	60		
Setting the language	60		
Restoring the DR-44WL to factory settings	60		
Completely format a SD card	61		
Power and display settings (POWER/DISPLAY)	61		

1 – Introduction

Features

- Compact audio recorder that uses SD/SDHC/SDXC cards as recording media
- Built-in with high performance directional stereo microphones in XY positions
- Mid-side decoding function can be used with MS microphones
- Simultaneous recording of up to four channels is possible
- Built-in four-track MTR feature
- Built-in Wi-Fi feature to use smartphone as remote control, transfer files from the PCM recorder, and play back audio
- 44.1/48/96 kHz, 16/24-bit, linear PCM (WAV format) recording possible
- Compatible with the BWF format
- 32–320 kbps MP3 format recording possible (compatible with ID3 tag v2.4)
- The dual recording feature allows two files to be recorded simultaneously at different levels
- Supports dual format recording (WAV/MP3)
- Built-in 0.3 W monaural output monitor speaker
- Built-in effector (reverb) function can be used during recording and playback
- Auto-record function starts recording automatically when a set sound input level is detected
- Track incrementing function allows you to update a file at a preset time or at desired position without interrupting recording
- Pre-recording (PRE REC) function allows the unit to record the 2 seconds of sound before recording is activated
- Peak reduction function is available to reduce the level automatically in case of excessively large input
- Limiter function is available to reduce the level automatically in case of excessively large input
- Low-cut filter conveniently reduces low-frequency noise
- VSA function can change the playback speed in the range from 0.5 to 2.0 times (in 0.1 increments) the normal speed without changing pitch
- IN-OUT loop playback functions

This product has a Blackfin® 16/32-bit embedded processor made by Analog Devices, Inc. This processor controls digital signal processing.

Inclusion of this Blackfin® processor in the product increases its performance and reduces its power consumption.

Conventions used in this manual

In this manual, we use the following conventions:

- When we refer to buttons, connectors and other parts of this unit and other equipment, we use a bold font like this: **MENU** button.
- When we show messages, for example, that appears on the unit's display, the typeface looks like this: **REPEAT**.
- Highlighted area on the DR-44WL display is indicated as a "cursor".
- SD/SDHC/SDXC memory cards are referred to as "SD cards".
- Words that appear on the computer display are shown in quotation marks like this: "DR-44WL"
- The selected folder is indicated as the "current folder".
- A computer or a smartphone that is connected with the DR-44WL via Wi-Fi is referred to as the "Wi-Fi device".
- Additional information is provided as "tips", "notes", and "caution" as required.

TIPS

These are tips about how to use the unit.

NOTE

These provide additional explanations and describe special cases.

CAUTION

Failure to follow these instructions could result in injury, damage to equipment or lost recording data, for example.

About SD cards

This unit uses SD cards for recording and playback.

You can use 64 MB to 2 GB SD cards, 4 GB to 32 GB SDHC cards, and 48 GB to 128 GB SDXC cards with this unit.

A list of SD cards that have been confirmed for use with this unit can be found on our web site. Please access to a product page of this product from the TEAC Global Site (<http://teac-global.com>) to find the list or contact the TASCAM customer support service.

Precautions

SD cards are delicate media. Please refer to the below when using memory cards to prevent memory and/or card damage:

- Do not leave a memory card in extremely hot or cold places
- Do not leave a memory card in extremely humid places
- Do not spill any liquids on the memory card
- Do not bend the card or subject it to any excessive force
- Do not subject the card to any physical shock
- Do not remove the card while the unit is accessing data, or recording, playing, or making data transfer
- Always store the memory card in a case

Trademarks and copyrights

- TASCAM is a trademark of TEAC CORPORATION, registered in the U.S. and other countries.
- SDXC Logo is a trademark of SD-3C, LLC.



- Supply of this product does not convey a license nor imply any right to distribute MPEG Layer-3 compliant content created with this product in revenue-generating broadcast systems (terrestrial, satellite, cable and/or other distribution channels), streaming applications (via Internet, intranets and/or other networks), other content distribution systems (pay-audio or audio-on-demand applications and the like) or on physical media (compact discs, digital versatile discs, semiconductor chips, hard drives, memory cards and the like). An independent license for such use is required. For details, please visit <http://mp3licensing.com>.
- MPEG Layer-3 audio coding technology licensed from Fraunhofer IIS and Thomson.
- Wi-Fi is a trademark of Wi-Fi Alliance. The Wi-Fi CERTIFIED Logo is a certification mark of Wi-Fi Alliance.
- Microsoft, Windows and Windows Vista are either registered trademarks or trademarks of Microsoft Corporation in the United States and/or other countries.
- Mac is a trademarks of Apple Inc.
- IOS is a trademark or registered trademark of Cisco in the U.S. and other countries and is used under license.
- App Store is a service mark of Apple Inc.
- Google Play and Android are trademarks of Google inc.
- Blackfin® and the Blackfin logo are registered trademarks of Analog Devices, Inc.
- Other company names, product names and logos in this document are the trademarks or registered trademarks of their respective owners.

2 – Names and functions of parts

Top panel

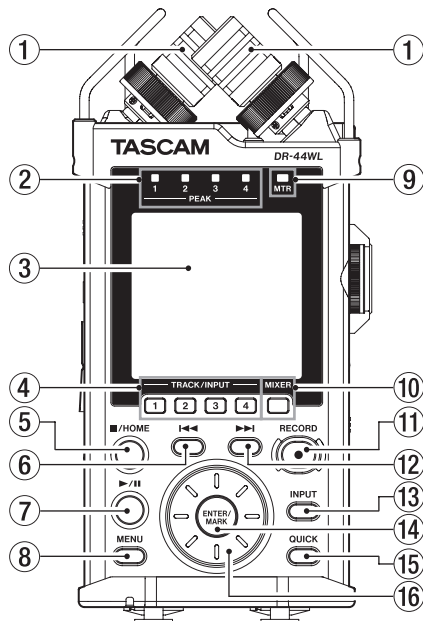

- ① **Built-in stereo microphone (INT R/INT L)**
This is an XY directional stereo electret condenser microphone.
On this unit, the mic that appears behind and on the left in the illustration is called INT R and the mic in front on the right is called INT L.
- ② **PEAK indicator**
Lights (red) when the input volume is too high (−2 dB).
- ③ **Display**
Displays a variety of information.
- ④ **TRACK/INPUT button**
During recording standby (4 CH mode) or when stopped (MTR mode), press this button to select the channel (track) to record.
When the **INPUT LEVEL** setting screen pops up, press this button to select the channel (track) for adjusting the input level.
When the **INPUT SETTING** screen is open, press these buttons to show channels (tracks) to set.
- ⑤ **■ /HOME button**
If you want to pause, press the button again.
Press this button during pause time to return to the beginning of the file.
Press this button during recording or recording standby to cause the recording to stop.
To return to the Home screen, press this button in any screen display. Use this button to select “NO” to a confirmation message.
- ⑥ **◀◀ button**
During playback or when stopped in the middle of a file, press to return to the beginning of the file.
When the IN and OUT points are set between the current position and the end of the playback file, pressing this button skips to those points.
If you press this button when a track is stopped at its beginning, the unit will skip to the beginning of the previous track.
Press and hold this button to search backwards.

- Press this button while pressing and holding the **ENTER/MARK** button to return to the previous mark.
On the setting screens, use this button to move the cursor left.
On the **BROWSE** screen, press this button to move up a level.
- ⑦ **▶ /II button**
To start playback in the Home screen, press this button while in stop mode.
If you want to pause, press the button again.
When a file or folder is selected on the **BROWSE** screen, press this button to return to the Home screen and play the file or the first file in the folder from the beginning.
- ⑧ **MENU button**
When the Home screen is displayed, press this button to open the **MENU** screen.
Press this button to return to the **MENU** screen from the various setting screens.
When the **MENU** screen is open, press this button to return to the Home screen.
- ⑨ **MTR indicator**
Lights up when the operation mode is in MTR mode.
- ⑩ **MIXER button**
Press this button to open the **MIXER** screen.
When the **MIXER** screen is open, press this button to return to the Home screen.
- ⑪ **RECORD button/RECORD indicator**
4CH mode:
When stopped, press this button to put the unit into recording standby. The **RECORD** indicator will start to blink.
When in standby, press this button to start recording. The **RECORD** indicator lights when recording.
Press when recording to pause recording. The **RECORD** indicator will start to blink.
MTR mode:
When stopped or playing back, press this button to start recording. The **RECORD** indicator lights when recording.
When recording, this button does not function.
- ⑫ **▶▶ Fast forward button**
Press this button in playback or stop mode to skip to the next track.
When the IN and OUT points are set between the current position and the end of the playback file, pressing this button skips to those points.
Press and hold this button for fast forward search.
On the setting screens, use this button to move the cursor right.
Press this button while pressing and holding the **ENTER/MARK** button to move forward to the next mark.
On the **BROWSE** screen, press this button to move down a level. If a file is selected, the file is loaded and the unit returns to the Home screen.
- ⑬ **INPUT button**
Press this button to open the **INPUT SETTING** screen.
When the **INPUT SETTING** screen is open, press this button to return to the Home screen.
- ⑭ **ENTER/MARK button**
Use this button to confirm selections or select “YES” to a confirmation message.
Press this button during recording to add a mark manually. (See “Manual cue marking during recording” on page 27.)
While pressing and holding this button during playback, press the **◀◀** button to return to the previous mark or

2 – Names and functions of parts

press the ►| button to move forward to the next mark. (See “Moving to the cue mark position” on page 28.)
When the **PLAY FUNCTION** screen is open, use this button to set the **IN** (start) and **OUT** (end) points of the interval that you want to set for loop playback. When the **IN** (start) and **OUT** (end) points are already set, press this button to clear the **IN** and **OUT** points.

15 QUICK button

When the Home screen, **PLAY FUNCTION** screen, **BROWSE** screen or **SONG** screen is open, press this button to pop up the quick menu. (See “**QUICK** button overview” on page 41.)

16 Wheel

This is used to select items or change value on setting screens. Also used to change the playback position in a file.

Front panel

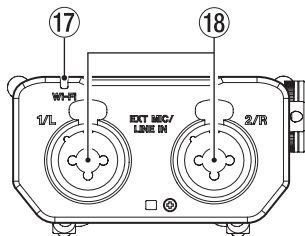

17 Wi-Fi indicator

Indicates the status of wireless LAN.

Lights out: OFF

Blinks: Waiting to be connected

Lights up: Operable from the exclusive application (DR CONTROL)

18 EXT MIC/LINE IN 1/L / 2/R jack (XLR/TRS)

These are balanced analog XLR/TRS combo jacks for microphone and line level inputs.

XLR (1: GND, 2: HOT, 3: COLD)

TRS (Tip: HOT, Ring: COLD, Sleeve: GND)

CAUTION

- Confirm that phantom power is OFF before connecting a line level device to these **EXT MIC/LINE IN** jacks. If you connect a line level device while phantom power is being supplied, that device and this unit could be damaged.
- When connecting to or disconnecting a condenser microphone from the **EXT MIC/LINE IN** jack, confirm that the phantom power for that jack is OFF. If you connect or disconnect a microphone while phantom power is being supplied, that microphone and this unit could be damaged.
- Do not connect an unbalanced dynamic microphone to an XLR connector when phantom power is being supplied. Doing so could damage that microphone and this unit.

Left side panel

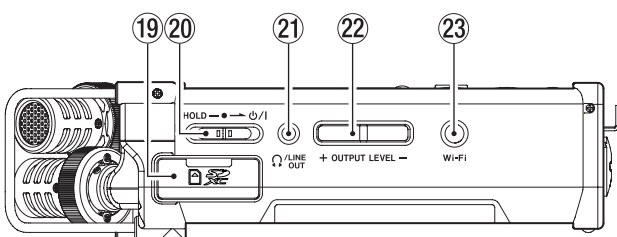

19 SD card slot

Insert or remove a SD card.

20 HOLD/⏻/I switch

To turn the power on/off, slide and hold the switch towards the ⏻/ I icon.

When you slide the switch towards the **HOLD** side, all the functions of the buttons are locked.

21 Ω/LINE OUT jack

A headphone or a line input jack of an external device (via stereo mini-jack cable) can be connected to this jack.

22 OUTPUT LEVEL button

These buttons adjust the output sound level of the built-in speaker or the Ω/LINE OUT jack.

During adjustment, a volume indicator will be displayed in a pull-up window.

23 Wi-Fi button

Use this button to turn on/off the Wi-Fi function.

Right side panel

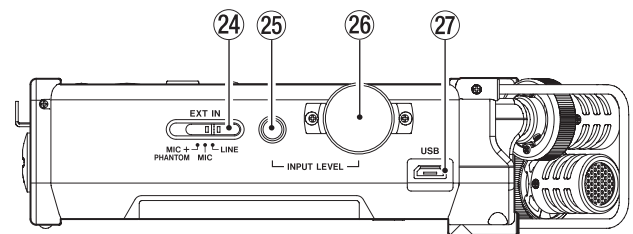

24 EXT IN switch

Set the gain for the **EXT MIC/LINE IN** jack and whether phantom power is on or off.

CAUTION

- Confirm that phantom power is OFF before connecting a line-level device to the **EXT MIC/LINE IN** connector. If you connect a line-level device while phantom power is being supplied, that device and this unit could be damaged.
- Do not connect or disconnect mics when the phantom power switch is set to ON. Doing so could cause a loud noise and might damage this unit and connected equipment.
- Turn phantom power ON only when using a condenser microphone that requires phantom power. Turning phantom power on when a dynamic mic or other mic that does not require it is connected could damage this unit and connected equipment.
- When using condenser mics that require phantom power and dynamic mics together, be sure to use balanced dynamic mics. Unbalanced dynamic mics cannot be used when phantom power is enabled.
- Supplying phantom power to some ribbon mics could break them. If you are unsure, do not supply phantom power to a ribbon mic.
- When using USB bus power, the unit might not be able to supply phantom power depending on the computer. If this occurs, use the included AC adapter (GPE053B).
- Some condenser microphones will not operate when phantom power is set to +24V.
- Do not connect or disconnect the AC adapter when using phantom power. Doing so could cause the unit to turn off even when batteries are installed in it. This can result in recording data being damaged or lost.

2 – Names and functions of parts

- 25 INPUT LEVEL button**
Press this button to show the **INPUT LEVEL** setting screen on the display as a pull-down menu.
When the **INPUT LEVEL** setting screen is shown, press this button to close the pull-down menu.
- 26 INPUT LEVEL volume**
When the **INPUT LEVEL** setting screen is shown, use this to adjust the input level.
- 27 USB port**
Use the supplied USB cable to connect the DR-44WL with a computer. (See “11 – Connecting with a computer” on page 52.)
Power can be supplied through the USB cable included within this unit package or the dedicated AC adapter (GPE053B) supplied with this unit.

CAUTION

Connect the DR-44WL directly be connected directly with the computer, not through a USB hub.

- 31 Strap holder**
A strap can be attached to this holder.

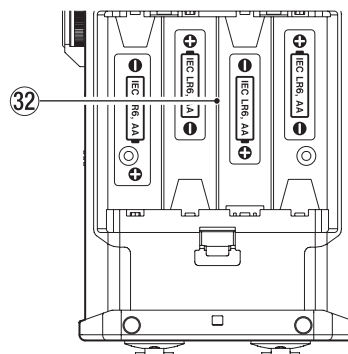

- 32 Battery compartment**
Insert four AA batteries into the compartment to power the unit. (See “Using AA size batteries” on page 12.)

Bottom panel

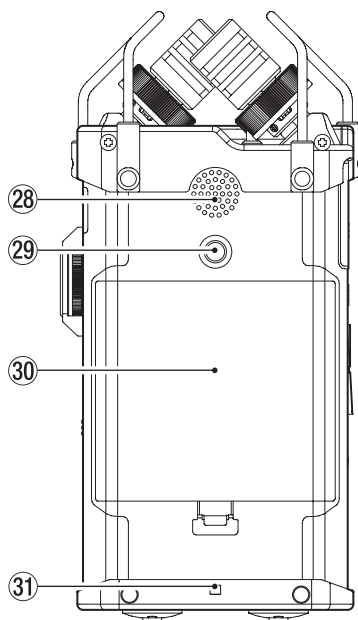

- 28 Built-in mono speaker**
Use this built-in speaker to listen to recordings.
No sound will play when:
- In recording standby
 - Headphone is connected
 - In recording mode
 - Speaker output setting is turned off
- 29 Tripod attachment screw-hole (1/4 inch)**
A tripod can be attached to the DR-44WL.

CAUTION

- Ensure the tripod or microphone stand screws are securely fastened to prevent the unit from falling off.
- When attaching this unit to a tripod or microphone stand, ensure to place it on a level surface.
- Some tripods have different screw specifications that make direct connection impossible. Use a commercially-available adapter with such tripods.

- 30 Battery compartment cover**

Home Screen

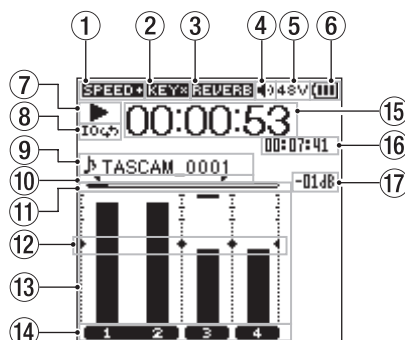

Home Screen in the 4 CH mode

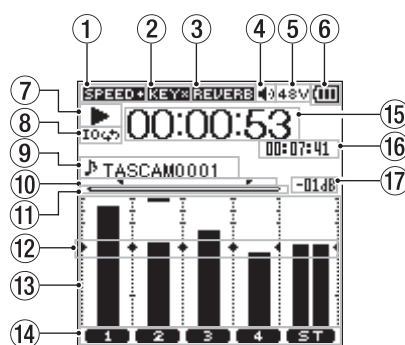

Home Screen in the MTR mode

- 1 Playback speed status display**
One of the following icons appears according to the playback speed setting.

Icon	Playback speed
Blank	Playback speed not changed
SPEED+	×1.1 – ×2.0
SPEED-	×0.5 – ×0.9
SPEED	When the playback speed cannot be changed

- 2 Display of the key control function on/off status**
This icon shows whether the key control function is on or off.

2 – Names and functions of parts

Icon	On/off status
Blank	Key control function off
	Key control function on
	Key control function on (setting disabled state)

③ Reverb on/off status display

This icon shows the reverb on/off status.

Icon	On/off status
Blank	Reverb is off
	Reverb is on (sound effects recording) INT MIC, EXT IN
	Reverb is on (SEND status) MIX

④ Speaker output display

displayed: Speaker output on

Blank: Speaker output off

⑤ Phantom power supply display

Blank: No phantom power supply

: 48V phantom power supplied

: 24V phantom power supplied

⑥ Power supply status message

When power is supplied from the batteries, the current battery level is displayed in bars (, , ,).

When the battery level is low, the will flash and the power will be switched off (standby mode).

When the dedicated AC adapter (GPE053B) supplied with the product or USB bus power is used, appears.

NOTE

When attempting recording or other operations that consume large amount of power, a warning message of Battery Low may pop-up.

⑦ Recorder status message

The recording status is indicated in the following icons:

Indicator	Detail
	Stop
	Pause
	Playback
	Fast-forwarding
	Fast-rewinding
	Skip forward to the beginning of the next file
	Skip backward to the beginning of either the current or preceding file

⑧ Loop playback setting status display

During loop playback, the icon is displayed.

⑨ Filename/song name display

When the 4CH mode is selected, the name or tag information of a file being played back is shown.

The ID3 tag information is displayed instead when included in the MP3 file.

When there are multiple files in the 4CH mode, only the format portion of each of the file names and the basic number of a recording file are displayed. When a single file is recorded, its name is shown.

When the MTR mode is selected, the name of an opened song is shown.

NOTE

ID3 tag information contains titles and artist names, which can be stored in MP3 files.

⑩ Loop playback IN (starting) and OUT (ending) points setting status

The IN (starting) and OUT (ending) points-setting state of the loop playback is shown.

When the IN (starting) point is set, the icon appears at the set position on the playback position-displaying bar.

The icon appears at the playback position on the bar when the OUT (ending) point is set.

⑪ Playback position display

The current playback position is shown by a bar. As playback progresses, the bar extends to the right.

⑫ Level meter guide display

This is a level meter guide for adjusting the input and output levels. It is displayed at the “-12 dB” position of the scale.

⑬ Level meter

This meter displays the level of an input sound or that of a playback sound.

⑭ File status display

The file state is displayed in different ways, depending on the type of a file to be played back.

: Stereo file status

: Status of two mono files

: No file

⑮ Elapsed time display

Displays the elapsed time (hours: minutes: seconds) of the current file.

⑯ Remaining time display

Displays the remaining time (hours: minutes: seconds) of the current file.

⑰ Peak value displayed in decibel (dB)

Displays the maximum playback level in decibel reading per set amount of time.

Recording Screen

The following recording screen is displayed in recording or recording standby mode.

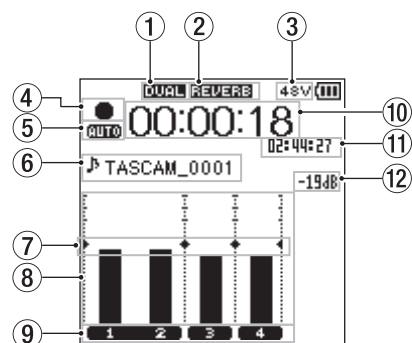

Recording screen in the 4 CH mode

2 – Names and functions of parts

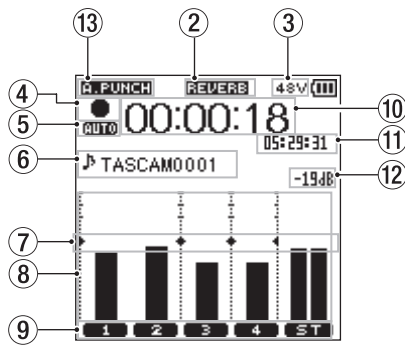

Recording screen in the MTR mode

① Display of the dual recording function on/off status (4CH mode only)

Blank: dual recording function off

□: dual recording function on

② Reverb on/off status display

This icon shows the reverb on/off status.

Icon	Detail
Blank	Reverb is off
REVERB	Reverb is on (sound effects recording) INT MIC, EXT IN
REVERB	Reverb is on (SEND status) MIX

③ Phantom power supply display

Blank: No phantom power supply

48V : 48V phantom power supplied

24V : 24V phantom power supplied

④ Recording status message

The recording status is indicated in the following icons:

Indicator	Detail
●	Recording standby or recording pause mode
●	In recording mode
⏰	Self-timer recording activated

⑤ Display of the setting status of the PRE REC or AUTO REC function (4CH mode only)

When the PRE REC function is ON, the **PRE** icon appears.

When the AUTO REC function is ON, the **AUTO** icon appears.

⑥ Filename/song name display

Displays the file name automatically assigned to the recording file.

When there are multiple files in the 4CH mode, only the format portion of each of the file names and the basic number of a recording file are displayed. When a single file is recorded, its name is shown.

When the MTR mode is selected, the name of an opened song is shown.

⑦ Level meter guide display

This is a level meter guide for adjusting the input and output levels. It is displayed at the “-12 dB” position of the scale.

⑧ Level meter

Displays the input sound level.

⑨ File status display

The file state is displayed in different ways, depending on the type of a file to be recorded.

1 2 : Stereo file status

1 2 : Status of two mono files

⑩ Elapsed recording time

Displays the elapsed recording time of a recorded file (hours: minutes: seconds).

⑪ Remaining recording time

The remaining time left on the SD card is shown in hours: minutes: seconds.

⑫ Peak decibel (dB) message

Displays the peak input level in decibel reading.

⑬ Auto punch in/out function on/off status or master track loading status (MTR mode only)

No icon: auto punch in/out function off

PUNCH: auto punch in/out function on

MASTER: master track loaded

Menu item list

Press the **MENU** button to open the **MENU** screen. Menu items are as follows:

Menu item	Function	Ref. page
MODE	Switch the operation mode of this unit.	page 17
REC SETTING	Make recording settings	page 18 page 25 page 26 page 29
AUTO FUNCTION	Set different recording functions.	page 24 page 25 page 28
BROWSE (4CH mode only)	SD card file and folder operations	page 32
SONG (MTR mode only)	Operate songs on the card.	page 35
TOOLS	Configure settings for different functions	page 15 page 48 page 49 page 53 page 55 page 57
REVERB	Configure reverb settings.	page 49
POWER/DISPLAY	Set the power and the display	page 61
SYSTEM	Various system settings	page 59 page 60

2 – Names and functions of parts

Using menus

The following explains the menus, using the display contrast setting as an example.

1. Press the **MENU** button to open the MENU screen.

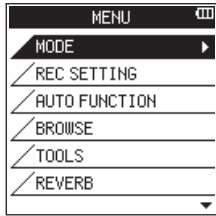

2. Use the **wheel** to select a menu item (highlighted), and press the **ENTER/MARK** or **▶▶** button to move to various settings screens.

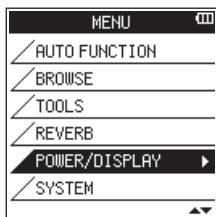

3. Use the **wheel** to select an item to set (highlighted).

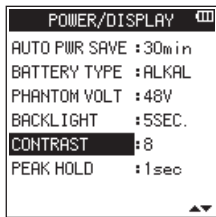

4. Press the **ENTER/MARK** or **▶▶** button to move the cursor to highlight the setting.

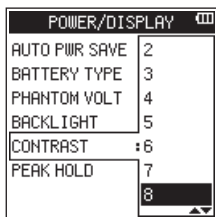

5. Use the **wheel** to change the setting.
6. Press the **ENTER/MARK** or **◀◀** button to set a different item in the same menu.
This enables you to select a new item. Use the **wheel** to select an item to be set (highlighted).
7. Repeat the 3. to 6. steps to set each items, as necessary.
8. Press the **MENU** button to return to the MENU screen.
Press the **■ /HOME** button to return to the Home screen.

Basic operations

Use the following buttons to operate the various screens.

■ MENU button

Opens the MENU screen.

■ ■ /HOME button

To return to the Home screen, press the **■ /HOME** button in any screen display.

Use this to answer "NO" to a confirmation message.

■ ENTER/MARK button

Use this button to confirm selection of a setting item or to select "YES" to a confirmation message.

■ ▶▶ button

Use this to move the cursor (the highlighted area) to the right on the screen or to open folders on the BROWSE screen.

■ ◀◀ button

Use this to move the cursor (the highlighted area) to the left on the screen, and to close folders on the BROWSE screen.

■ Wheel

Use this to select (highlight) each item or to change value.

■ MIXER button

Open the MIXER screen.

■ INPUT button

Open the INPUT SETTING screen.

■ QUICK button

This opens the quick menu pop-up. (See "QUICK button overview" on page 41.)

3 – Preparation

Powering the unit

Power sources

The DR-44WL operates on four AA batteries, the dedicated AC adapter (GPE053B) included with the unit or USB cable supplied with the unit (USB bus power).

Use either alkaline batteries or Ni-MH batteries.

Using AA size batteries

Remove the battery compartment cover on the back of the unit, insert four AA batteries into the battery compartment, aligning to the ⊕ and ⊖ markings inside the battery compartment, and close the cover.

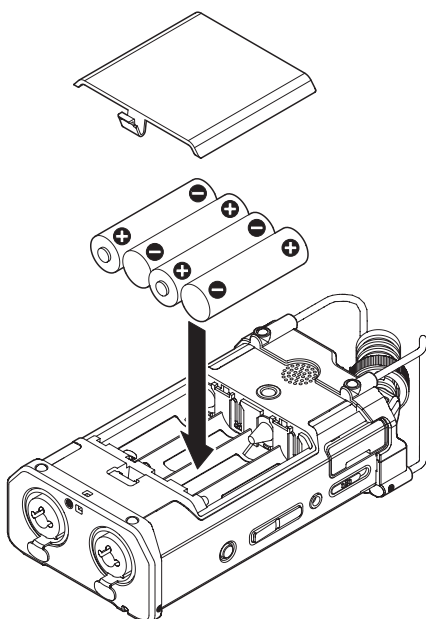

Select the same type of batteries to get an accurate reading of the remaining battery power and required minimum power for operation. (See “Battery type settings” on page 61.)

CAUTION

- Do not use Manganese dry cell batteries.
- Ni-MH batteries will not be recharged with this unit; use a separate battery recharger instead.
- The supplied alkaline batteries are for testing and may not last long.

NOTE

A large amount of power is consumed to provide phantom power to a condenser microphone. If you use a condenser microphone while running the unit on AA batteries (NiMH rechargeable or alkaline), the operating time will be extremely shortened.

If you need to operate the unit for a long time, use the dedicated AC adapter (GPE053B) included with the unit or TASCAM BP-6AA external battery box (sold separately) to power the unit.

Using an AC adapter

Connect the dedicated AC adapter (GPE053B) supplied with the unit and the USB port of the unit with the included USB cable as shown in the illustration.

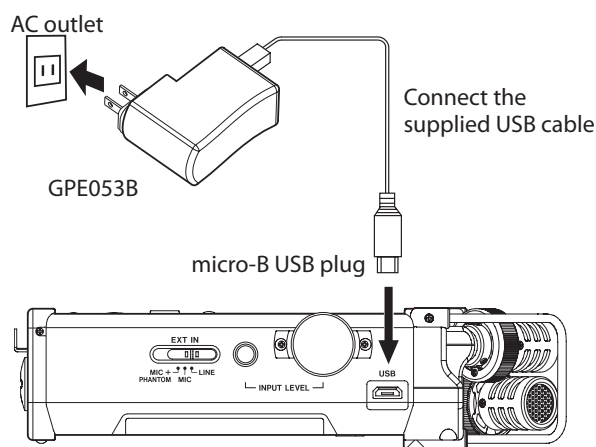

NOTE

- When both batteries and the AC adapter are attached to the unit, power will be supplied from the AC adapter.
- The included AC adapter for the unit comes with two types of outlet plugs. Attach the type of plug that matches the power outlet that you are using.

CAUTION

- Use only the dedicated AC adapter (GPE053B) supplied with the unit. The use of another adapter may cause malfunction, fire or electric shock.
- Noise may occur during microphone recording when the unit and AC adapter are in close proximity. If noise occurs, move the AC adapter away from the unit.

Changing the outlet plug

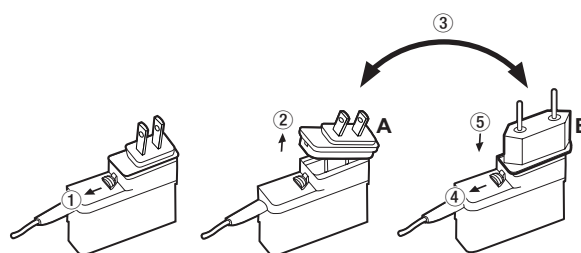

- ① Move the latch on the AC adapter in the direction of the arrow.
- ② Pull off the outlet plug.
- ③ Replace it with the other outlet plug (A or B).
- ④ Move the latch on the AC adapter in the direction of the arrow again.
- ⑤ Attach the outlet plug to the AC adapter.

This completes changing the outlet plug.

After changing the outlet plug, confirm that it is not loose or crooked and that everything is normal before plugging it into an outlet.

CAUTION

Do not use the adapter if there is anything abnormal about the plug after changing it. Use when the plug is abnormal could cause fire or electric shock. Contact the store where you purchased this unit or a TASCAM customer support service to request repair.

Using an external battery pack (sold separately)

Connect a TASCAM BP-6AA external battery pack (designed for use with this unit and sold separately) to the recorder with the included USB cable as shown in the illustration. For details, see the BP-6AA Owner's Manual.

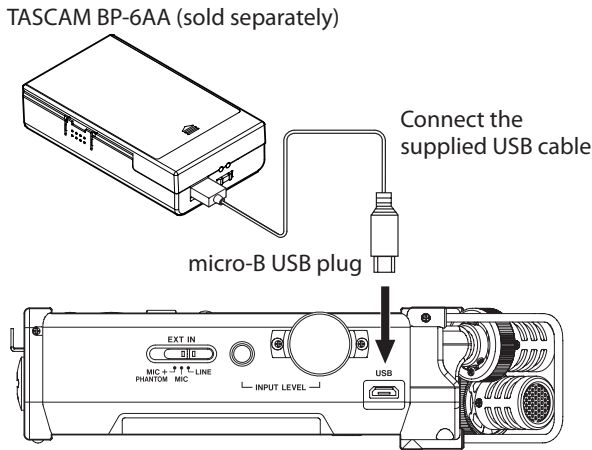

CAUTION

The DR-44WL cannot detect the remaining battery charge of a BP-6AA. If you use a BP-6AA to operate the DR-44WL without batteries in the recorder itself, the unit might stop operating suddenly if the battery pack runs out of charge. In order to avoid problems, put batteries with sufficient charge into the DR-44WL before connecting and using a BP-6AA.

Using USB bus power

Use the supplied USB cable to connect the unit and the computer as illustrated below.

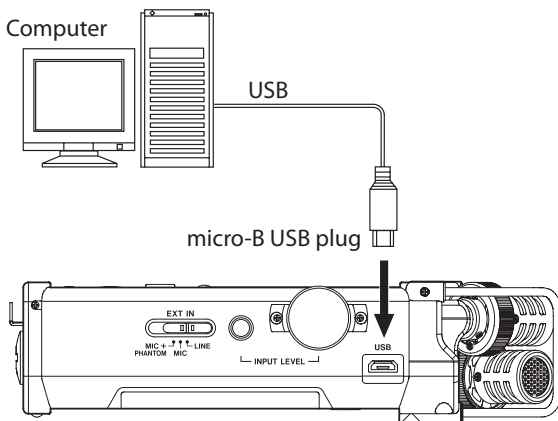

When you connect a USB cable while the unit power is on, or turn on the power after making a connection, the **USB SELECT** screen will pop up, prompting the user to select either to operate the unit with USB bus power or make a USB connection with the computer.

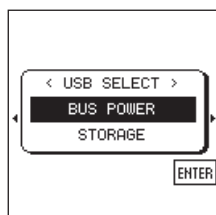

Use the **wheel** to select **BUS POWER** (highlighted) and press the **ENTER/MARK** button to select power supply from the USB port. The Home screen will appear.

NOTE

Power is supplied from the USB port when USB cable is connected to the unit inserted with batteries (USB bus power prioritized).

CAUTION

- Depending on the USB bus power specifications of the computer, the DR-44WL may not operate with a USB connection. If this occurs, use the dedicated AC adapter (GPE053B) supplied with the unit instead.
- This unit is not compatible with the computer's power-save mode or sleep-mode. Please turn off these modes when operating the unit from the computer's USB bus power.

Turning the power on and off (standby mode)

CAUTION

- When you turn the power switch off while supplying power from the dedicated AC adapter (GPE053B) included with the unit or the USB bus power connected to a computer, the unit will go into standby mode.
- Before turning the power switch on and off, turn the volume down for the sound system connected to the unit.
- Do not wear headphones when turning the power switch on and off (standby mode); the noise may cause damage to your ears and/or headphones.

Starting up the unit

When the unit is turned off, slide the **HOLD/⏻/|** switch of the left side panel in the **⏻/|** direction, and when the TASCAM DR-44WL (start-up screen) appears, release the switch. The DR-44WL starts up and the Home screen is displayed.

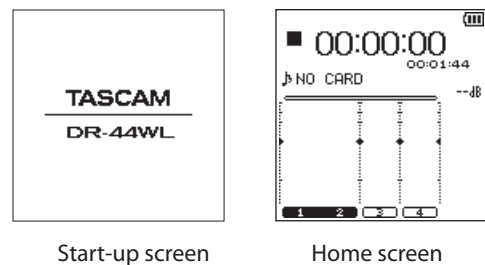

CAUTION

When turn the power on for the first time (or when the built-in clock is reset due to no battery power), the **DATE/TIME** screen will appear before the Home screen to set date/time. (See "Song Operation" on page 35.)

Shutting down (standby mode)

When the unit is turned on, slide the **HOLD/⏻/|** switch of the left side panel in the **⏻/|** direction, and when the TASCAM DR-44WL **shutting down...** appears, release the switch. The power turns off after the unit completes its shutdown process.

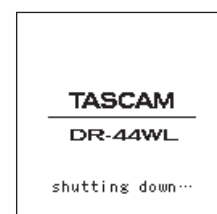

3 – Preparation

CAUTION

Always use the **HOLD/⏻/ I** switch to turn the power off. Do not remove the batteries or disconnect the power cable (AC adapter GPE053B included with the unit or USB cable) accidentally while the unit is operating. If you do so, the unit cannot shut down properly and all recordings, settings and other data will be lost. Any lost data and/or settings cannot be restored.

Resume function

The DR-44WL is equipped with a resume function to locate the previous position (or time) when the power was turned off. Turn the power on and press the **▶/||** button to play back from the previous file position (time) when the power was turned off.

NOTE

The position is recorded in the SD card. The resume function does not work if the SD card is replaced or formatted.

Selecting the language

You can change the language shown on the display. The first time you turn the unit on after purchasing it, the **LANGUAGE** screen will open. You can set the language used on this screen. You can also change this setting with the **SYSTEM** screen **LANGUAGE** item.



1. Turn the wheel to move the cursor and select the language.

Options

English:	use English
日本語:	use Japanese
Français:	use French
Español:	use Spanish
Deutsch:	use German
Italiano:	use Italian
Русский:	use Russian

2. After making the selection, press the **ENTER/MARK** button to confirm it.

If you accidentally select the wrong language

Slide the **HOLD/⏻/ I** switch to turn the power off. Then, slide the **HOLD/⏻/ I** switch while pressing and holding the **MENU** button to turn the unit on again.

The language selection menu where you can set the language appears.

Setting the date/time

The DR-44WL uses its internal clock to record the date and time to the recorded files.

1. Press the **MENU** button to open the **MENU** screen.

2. Using the **wheel**, select (highlight) **SYSTEM** menu item and press the **ENTER/MARK** or **▶▶** button. The **SYSTEM** screen is displayed.
3. Use the wheel to select **DATE/TIME** and press the **ENTER/MARK** or **▶▶** button. **Exec** appears selected for the **DATE/TIME** item.

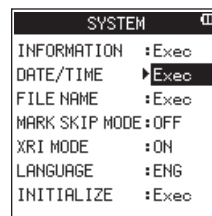

4. Press the **ENTER/MARK** button to open the **DATE/TIME** screen.

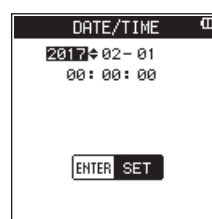

5. Press the **◀◀** button or **▶▶** button to move the cursor (highlighted area), and use the **wheel** to change values.
6. Press the **ENTER/MARK** button to confirm the change and return to the **SYSTEM** screen.

NOTE

The file name will include the set date/time. (See "Setting the file name type" on page 60.)

CAUTION

The date and time setting can only be maintained for a few minutes if the battery power becomes low or the unit is not powered by the dedicated AC adapter (GPE053B) included with the unit or USB cable.

When using batteries, we recommend to replace them before they are completely drained.

Inserting and removing SD cards

Inserting the SD card

NOTE

When the product is purchased, the SD card slot has an SD card already installed. If you want to use this SD card to record and play tracks, there is no need to reinstall it.

1. Open the SD card slot cover on the left side panel.
2. Insert the SD card into the slot as shown in the following illustration until it clicks into place.

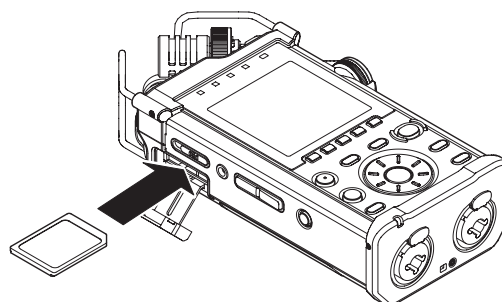

Removing the card

1. Open the SD card slot cover.
2. Press the SD card in gently and then release it to allow it to come out.

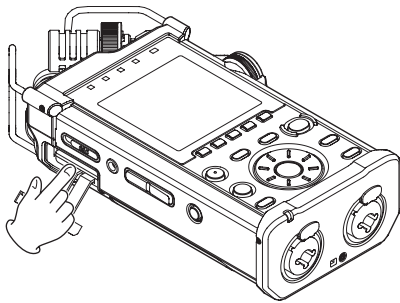

CAUTION

- Do not remove the SD card from the unit during recording, playback or at other times when it is being accessed.
- Do not remove the SD card from the unit when it is connected to a computer via USB.
- SD cards that meet SD, SDHC or SDXC standards can be used with this unit.
- A list of SD cards that have been confirmed for use with this unit can be found on our web site. Please access to a product page of this product from the TEAC Global Site (<http://teac-global.com>) to find the list or contact the TASCAM customer support service.
- When using a microSD card in an SD card adapter, do not remove just the microSD card. Always remove the adapter with the microSD card in it. Removing only the microSD card could cause malfunction.

SD card write protection switches

An SD card comes equipped with a write protect switch.

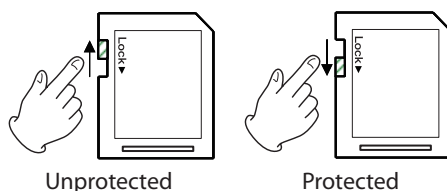

If you slide the protect switch to the LOCK position, file recording and editing is not possible. Move the switch to the unlocked position in order to record, erase and otherwise edit data on the card.

Preparing an SD card for use

In order to use an SD card in this unit, you must format it first.

1. Confirm that an SD card is installed and turn the power ON.
2. The following message appears when a new card or a card formatted by another device is inserted into the unit.

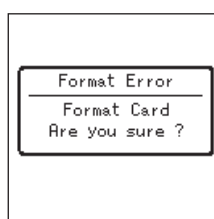

SD/SDHC card



SDXC card

3. Press the **ENTER/MARK** button to start formatting.

CAUTION

Formatting an SD card erases all the data on it.

4. When formatting is complete, it will return to the Home screen. You may format the card whenever required.

CAUTION

When formatting the SD card, make sure the unit is connected to the dedicated AC adapter (GPE053B) included with the unit, a computer via USB bus power, or fully-charged batteries.

Turning the built-in speaker on/off

The factory setting for the built-in speaker output is selected as ON. To turn it off, open the **TOOLS** screen and select OFF for the **SPEAKER** setting.

1. Press the **MENU** button to open the **MENU** screen.
2. Using the **wheel**, select (highlight) **TOOLS** menu item and press the **ENTER/MARK** or **▶▶** button. **TOOLS** screen appears.
3. Using the **wheel**, select (highlight) **SPEAKER** and press the **ENTER/MARK** or **▶▶** button.

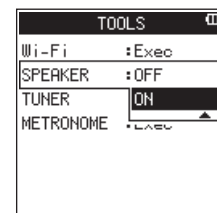

4. Using the **wheel**, turn on or off and press the **ENTER/MARK** button.

Options: OFF, ON (default setting)

5. Once the setting has been completed, press the **■/HOME** button to return to the Home screen.

NOTE

*In a recording standby or recording mode, or when a headphone or a speaker system is connected to the DR-44WL, the built-in speaker will not emit sound even when the **SPEAKER** setting is ON.*

Connecting a monitor device

To listen with a headphone, connect it to the **Ω/LINE OUT** jack. External monitor system (powered monitor speaker or an amplifier and speaker): connect the external monitor system to the **Ω/LINE OUT** jack.

3 – Preparation

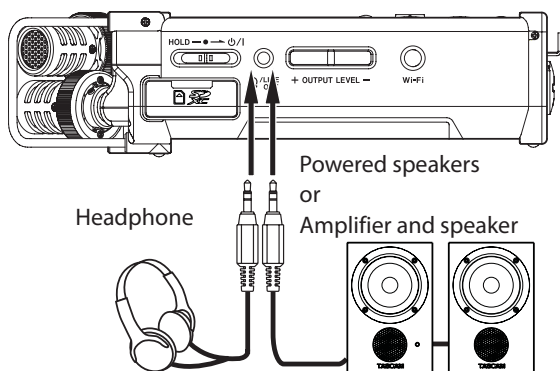

Adjusting the playback volume

When the Home screen is being displayed, use the **OUTPUT LEVEL (+/-)** button on the left side panel to adjust the volume of output through the built-in speaker or the Ω /LINE OUT jack. A volume level indicator will pull up at the bottom of the display.

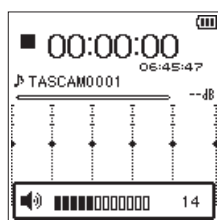
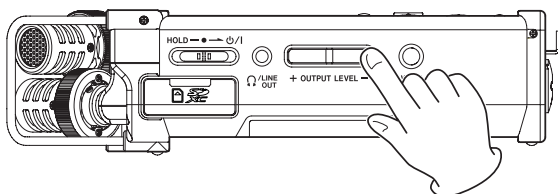

When increasing the volume, this pop-up message might appear: "INCREASE YOUR RISK OF HEARING DAMAGE."



This warning appears when the volume is set above a level recommended by the European Union (EU) to avoid hearing damage (EU volume limit regulation). Reconnecting headphones will reset the volume to its default value.

NOTE

- You can continue to adjust the volume even after the pop-up message appears. When you raise or lower the volume, the pop-up message will disappear.
- If the output level is set to 12 or higher and the unit is restarted when headphones or another device are connected to the Ω /LINE OUT jack, the upper level will be set to 12 after the unit restarts.

CAUTION

Listening at high volumes could cause hearing damage. If the surroundings are noisy, the sound of playback might seem quieter than it actually is. Start playback of the audio and check the volume before putting on headphones, for example.

Input settings

Recording with the built-in microphone

Point the built-in microphone toward the sound source and place the unit on a stable surface with minimum vibration.

NOTE

During mono recording, orient the mic set for the recording channel toward the sound source.

Recording with an external microphone (EXT MIC IN)

Connect an external microphone to the **EXT MIC/LINE IN** jack of this unit.

Point the external microphone toward the sound source and place the unit on a stable surface with minimum vibration.

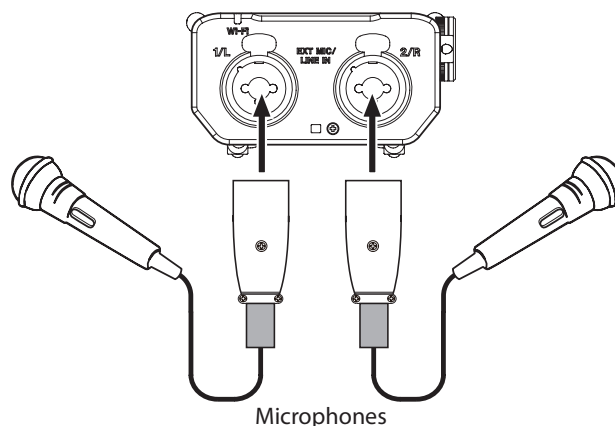

NOTE

To provide phantom power to a condenser microphone, set the **EXT IN** switch to **MIC+PHANTOM**. (See "Set the input gain" on page 19.)

Recording from an external device (LINE IN)

Use stereo plug cables to connect to the output of an external audio device.

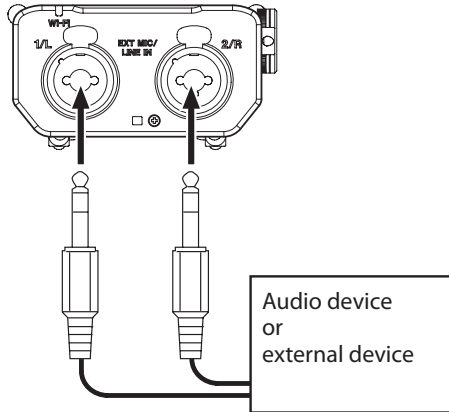

CAUTION

- If the input sound is still distorted after adjusting the input level of the unit, reduce the playback sound of the external device.
- When an external audio device with a fixed output line level is connected, it would be impossible to control the gain level appropriately because of excessively large input signals. In such cases, use the headphone jack or other level-controllable output for connection to the unit.

Selecting Operation Mode

Two operation modes are available in this unit: 4CH and MTR modes. (See “Overview of recording modes” on page 18.)

Setting a mode

1. Press the **MENU** button to open the MENU screen.
2. Using the **wheel**, select (highlight) **MODE** menu item and press the **ENTER/MARK** or **▶▶** button. The **MODE** screen is displayed.
3. Using the **wheel**, select (highlight) **MODE** and press the **ENTER/MARK** or **▶▶** button.

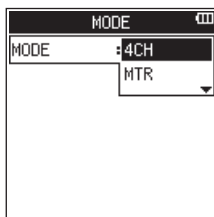

4. Use the **wheel** to select operation mode. Options: 4CH (default value), MTR
5. Once the setting has been completed, press the **■/HOME** button to return to the Home screen.

NOTE

The selected mode is stored and started in the selected mode when the power is turned on next time.

Checking mode

When the operation mode is set to MTR, the **MTR** indicator on the top of the display lights up.

Attaching the grip

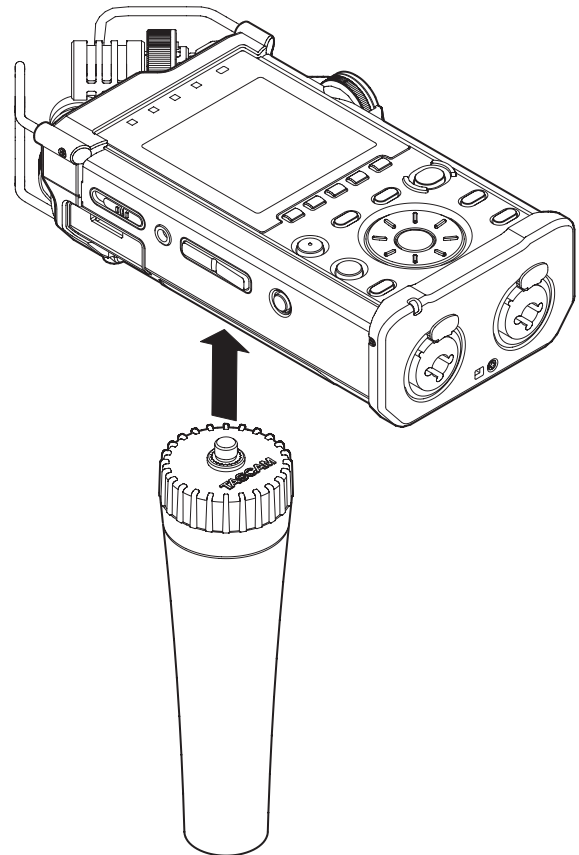

You can attach the included grip to the tripod mounting threads (1/4-inch) on the bottom of the unit and use it as a handgrip. You can also use the grip to attach the unit to a mic stand.

Attaching the shoe mount adapter

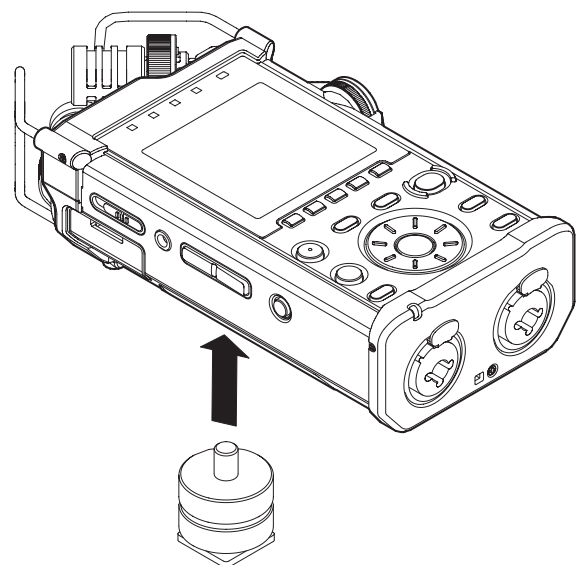

Attach the included shoe mount adapter to the tripod mounting threads on the bottom of the unit to use this unit as an audio recorder with a digital SLR camera or video camera, for example.

4 – Recording

In addition to the built-in microphone, an external microphone or external audio devices (i.e. CD player) can also be used for recordings.

Recordings can be made in MP3 (32k -320kbps, 44.1k/48kHz) and WAV/BWF (44.1k/48k/96kHz, 16/24-bit) audio formats.

Cue marks in WAV file that supports BWF (Broadcast Wave Format) can be used in BWF compatible softwares.

Overview of recording modes

This recorder can record sounds in two modes: 4CH and MTR modes.

■ 4CH mode

A maximum of four channels can be recorded simultaneously from the built-in mics and external input jacks (input jack assignments are fixed).

The recorded files are as follows according to the recording channel link settings.

- Mono × 1–4
- Stereo × 1–2
- Stereo × 1 + Mono × 1–2 (WAV or BWF only)

■ MTR mode

You can use this device as a multitrack recorder (MTR) to record individual tracks and overdub them.

A maximum of four channels can be recorded simultaneously from the built-in mics and external input jacks (input jack assignments can be selected). These can also be recorded into already recorded files (overdubbing).

The recorded files are as follows.

- Mono × 4

Set where to save the file

Set the folder where recorded files are saved.

The recorded file will be saved in the current (currently selected) folder. For details, see the **SELECT** quick menu item under (See “Folder operations” on page 33.).

In 4CH mode if no setting is made, new recording files are created in the “MUSIC” folder.

In MTR mode, new recording files are created in the “MTR” folder.

Select the file format and sampling frequency (4CH mode only)

Select the desired audio file type before you start recording.

1. Press the **MENU** button to open the **MENU** screen.
2. Using the **wheel**, select (highlight) **REC SETTING** and press the **ENTER/MARK** or **▶▶▶** button.

The **REC SETTING** screen appears.

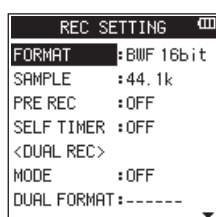

3. Using the **wheel**, select (highlight) **FORMAT** and press the **ENTER/MARK** or **▶▶▶** button.

Set the file format.

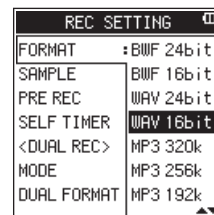

Using the **wheel**, select one of the following options.

Options: **BWF 24bit**, **BWF 16bit**, **WAV 24bit**, **WAV 16bit** (default value), **MP3 320k**, **MP3 256k**, **MP3 192k**, **MP3 128k**, **MP3 96k**, **MP3 64k**, **MP3 32k**

NOTE

- **BWF is a format created for broadcasting that has the same sound quality as the standard WAV format. It also uses the same .wav file extension as WAV files. In this manual, we distinguish these file types by using the terms BWF and WAV.**
- **The WAV and BWF formats offer higher quality recording than MP3 files.**
- **The MP3 format can record for longer hours compared to the WAV and BWF formats.**
- **With MP3 format, recording with higher values offers better quality.**

4. Press the **ENTER/MARK** or **◀◀◀** button to confirm the setting and enable selection of other setting items.
 5. Using the **wheel**, select (highlight) **SAMPLE** and press the **ENTER/MARK** or **▶▶▶** button.
- Set the sampling frequency.

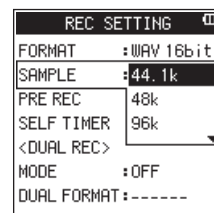

Using the wheel, select one of the following options.

Options: **44.1k** (default value), **48k**, **96k**

NOTE

96k cannot be selected for a MP3 format file.

TIP

You can record with audio quality equivalent to a CD by selecting **WAV 16bit and **44.1k**.**

6. Press the **ENTER/MARK** or **◀◀◀** button to confirm the setting and enable selection of other setting items.
7. Once the setting has been completed, press the **■/HOME** button to return to the Home screen.

Adjusting the input level

Before starting recording, the input level should be adjusted to prevent the recorded sounds or signals from being distorted due to excessively large input signals or from being inaudible due to excessively low input signals compared to noise.

In addition to manual adjustment, the unit has the following two level adjustment functions: peak reduction and limiter. Any of these can be used as required. (See “How to download and install the exclusive application (DR CONTROL)” on page 53.)

TIPS

In addition to adjusting the INPUT level, try changing the distance and angle between the microphone and the sound source. The angle and distance of the microphone can also change the sound quality.

1. In the Home screen mode, press the **INPUT LEVEL** button at the right side panel to make the **INPUT LEVEL** setting screen pop up.
All the **TRACK/INPUT** buttons start flashing.

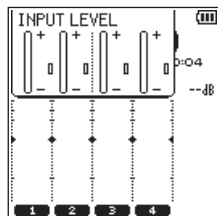

Press a **TRACK/INPUT** button to select a channel (track) for input level adjustment.

Selected **TRACK/INPUT** buttons light.

NOTE

If you select multiple channels/tracks (1/2 or 3/4) for input level adjustment, you can adjust them at the same time.

2. Use the **INPUT LEVEL** volume of the right side panel to adjust the input level.

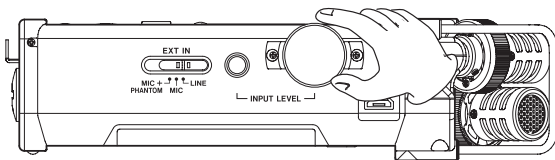

When the input sound is too loud, the **PEAK** indicator of the top panel is lit in red.

A ► ◀ mark is provided at the “-12 dB” position on the level meters.

Set the input level so that the level changes near this mark without causing the **PEAK** indicator to light in red.

3. Press the **INPUT LEVEL** button at the right side panel or the **ENTER/HOME** button at the top panel to return to the HOME screen.

NOTE

*When in recording standby or during recording, the speaker does not output sound even if the **SPEAKER** setting is enabled.*

*If you need to monitor sound to adjust the input level and make recordings, connect the headphone to the **LINE OUT** jack.*

*To adjust monitor sound, go to the Home screen and use the **OUTPUT LEVEL** button at the left side panel. Adjusting the monitor sound will not affect the recording quality.*

Set the input gain

When an external input is selected for the input source, select the option for the **EXT IN** switch at the right side panel to suit the connected external device.

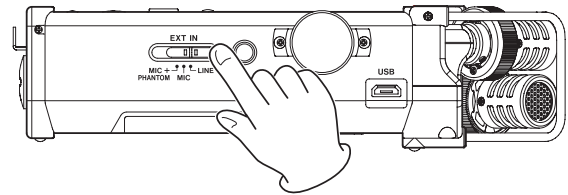

■ MIC+PHANTOM:

Use this setting when connecting condenser microphones that require phantom power (+24V or +48V) to the recorder. (See “Using phantom power” on page 19.)

■ MIC:

Use this setting when connecting microphones to the recorder.

■ LINE:

Use this setting when connecting line output jacks of external devices to the analog inputs of this recorder.

CAUTION

Depending on this setting, the input level setting range changes. For this reason, the input level might change greatly when this setting is changed. Before changing it, you should turn the power OFF or turn the output level all the way down.

Using phantom power

In stop mode, if you change the **EXT IN** switch at the right side panel to **MIC+PHANTOM**, a pop-up message appears confirming that you want to turn phantom power on.

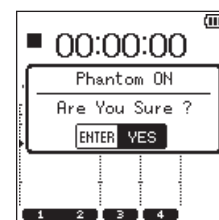

When the confirmation pop-up message opens, press the **ENTER/MARK** button to turn phantom power on for the **EXT MIC/LINE IN** jack and supply phantom power (+24V or +48V) to the connected microphone.

While the confirmation pop-up message is displayed, change the **EXT IN** switch to either **MIC** or **LINE** to close the confirmation pop-up message and turn phantom power off.

Use the **POWER/DISPLAY** screen to set the voltage to +24V or +48V. (See “Set the voltage value of the phantom power supply” on page 61.)

NOTE

Battery power will be consumed faster when set to +48V than when set to +24V.

CAUTION

- Confirm that phantom power is OFF before connecting a line level device to the **EXT MIC/LINE IN** jack. If you connect a line level device while phantom power is being supplied, that device and this unit could be damaged.

4 – Recording

- When connecting to or disconnecting a condenser microphone from the EXT MIC/LINE IN jack, confirm that the phantom power for that jack is OFF. If you connect or disconnect a microphone while phantom power is being supplied, that microphone and this unit could be damaged.
- Turn phantom power ON only when using a condenser microphone that requires phantom power.
- Supplying phantom power to some ribbon microphones will break them. If you are unsure, do not supply phantom power to a ribbon microphone.
- When using USB bus power, the unit might not be able to supply phantom power depending on the computer. If this occurs, use the dedicated AC adapter (GPE053B) supplied with the unit instead.
- Some condenser microphones will not operate when phantom power is set to +24V.
- Do not connect or disconnect the AC adapter when using phantom power. Even when the battery were inserted in the unit, the power might be cut off, causing data being recorded to be damaged or lost.

Settings in the INPUT SETTING screen

The contents of the INPUT SETTING screen displayed by pressing the INPUT button vary depending on which mode to be selected between 4CH mode and MTR mode.

	LINK	DELAY	LOW CUT	LU CTRL
1	OFF	0	OFF	OFF
2	OFF	0	OFF	OFF
3	OFF	0	OFF	OFF
4	OFF	0	OFF	OFF

INPUT SETTING screen TRACK 1 display when in 4CH mode

	INPUT	DELAY	LOW CUT	LU CTRL
1	INTL	0	OFF	OFF
2	INTR	0	OFF	OFF
3	EXT1	0	OFF	OFF
4	EXT2	0	OFF	OFF

INPUT SETTING screen TRACK 1 display when in MTR mode

NOTE

When a channel (track) link is turned on, the link status shown at the bottom of the INPUT SETTING screen will change.

	LINK	DELAY	LOW CUT	LU CTRL
1	ON	0	OFF	OFF
2	OFF	0	OFF	OFF
3	OFF	0	OFF	OFF
4	OFF	0	OFF	OFF

INPUT SETTING screen TRACK 1 display when in 4CH mode

Setting channel links (4CH mode only)

Channels 1 and 2, as well as channels 3 and 4, can be linked. When channels (tracks) are linked, their settings on the INPUT SETTING screen are shared.

1. Press the **INPUT** button to show the INPUT SETTING screen.
2. Press a **TRACK/INPUT** button to open the INPUT SETTING screen for the linked channels (tracks).
3. Using the **wheel** select (highlight) LINK and press the **ENTER/MARK** or **▶▶I** button.

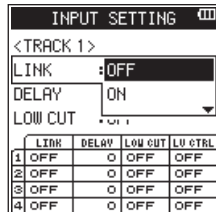

4. Use the **wheel** to set the channel (track) link.
Options: OFF (default value), ON
5. Press the **ENTER/MARK** button to confirm the setting and enable selection of other setting items.
6. Once the setting has been completed, press the **■/HOME** button to return to the Home screen.

NOTE

LINK can be set or changed even during recording standby and when recording.

Set the track input (MTR mode only)

1. Press the **MENU** button to open the MENU screen.
2. Using the **wheel**, select (highlight) MODE and press the **ENTER/MARK** or **▶▶I** button.
The MODE screen is displayed.
3. Press the **ENTER/MARK** or **▶▶I** button.

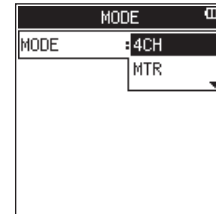

4. Using the **wheel**, set the mode to MTR mode and press the **ENTER/MARK** button.
Options: 4CH (4 CH mode, default value), MTR (MTR mode)
5. Press the **INPUT** button to show the INPUT SETTING screen.
6. Press a **TRACK/INPUT** button to open the INPUT SETTING screen for that track to set its input.
7. Using the **wheel**, select (highlight) INPUT and press the **ENTER/MARK** or **▶▶I** button.

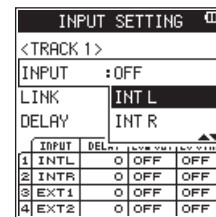

INPUT SETTING screen TRACK 1 display when in MTR mode

Option	Input destination
OFF	No input setting
INT L (Track 1 default)	Input from right front side of built-in stereo mic
INT R	Input from left back side of built-in stereo mic
EXT 1	Input from EXT MIC/LINE IN 1/L jack
EXT 2	Input from EXT MIC/LINE IN 2/R jack

8. Press the **ENTER/MARK** button to confirm the setting and enable selection of other setting items.
9. Once the setting has been completed, press the **■/HOME** button to return to the Home screen.

NOTE

- The **INPUT** setting cannot be used when recording.
- The same input option cannot be shared by multiple tracks. If an input option that has already been assigned is selected, the track that was originally assigned will be set to OFF.

4 – Recording

DELAY setting

Correct a time delay that occurs when the built-in microphones are far away from an external microphone.

1. Press the **INPUT** button to show the **INPUT SETTING** screen.
2. Press a **TRACK/INPUT** button to open the **INPUT SETTING** screen for that channel (track) to set its **DELAY** item.
3. Using the **wheel** select (highlight) **DELAY** and press the **ENTER/MARK** or **▶▶I** button.

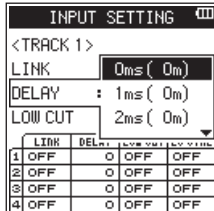

INPUT SETTING screen **TRACK 1** display when in 4CH mode

4. Use the **wheel** to set a value according to the distance of the connected microphone.
Options: **0ms (0m)** (default value) to **300ms (103m)**
5. Press the **ENTER/MARK** button to confirm the setting and enable selection of other setting items.
6. Once the setting has been completed, press the **■/HOME** button to return to the Home screen.

Set the low-cut filter

The low-cut filter can reduce noise such as offensive wind noise from air-conditioners and projectors.

1. Press the **INPUT** button to show the **INPUT SETTING** screen.
2. Press a **TRACK/INPUT** button to open the **INPUT SETTING** screen for that channel (track) to set its low-cut filter.
3. Using the **wheel** select (highlight) **LOW CUT** and press the **ENTER/MARK** or **▶▶I** button.

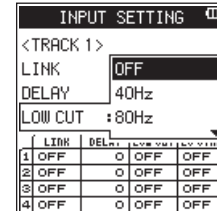

INPUT SETTING screen **TRACK 1** display when in 4CH mode

4. Use the **wheel** to set the cut-off frequency of the low-cut filter.
Options: **OFF** (default value), **40Hz**, **80Hz**, **120Hz**, **220Hz**
5. Press the **ENTER/MARK** button to confirm the setting and enable selection of other setting items.
6. Once the setting has been completed, press the **■/HOME** button to return to the Home screen.

NOTE

LOW CUT can be set or changed even during recording standby.

Using the level control function

You can set the input level for microphone input.

1. Press the **INPUT** button to show the **INPUT SETTING** screen.
2. Press a **TRACK/INPUT** button to open the **INPUT SETTING** screen for that channel (track) to set its level control function.
3. Using the **wheel** select (highlight) **LV CTRL** and press the **ENTER/MARK** or **▶▶** button.

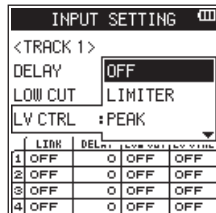

INPUT SETTING screen when in 4CH mode

4. Use the **wheel** to set the level to be used.
Options: **OFF** (default value), **LIMITER**, **PEAK**
5. Press the **ENTER/MARK** button to confirm the setting and enable selection of other setting items.
6. Once the setting has been completed, press the **■/HOME** button to return to the Home screen.

NOTE

LV CTRL can be set or changed even during recording standby and when recording.

■ PEAK

This function is used to automatically lower the input level to an appropriate one when an input sound is too loud. This allows input level setting to be performed easily. The input level can be raised manually if required.

TIPS

When recording live performances, for example, test for peak reduction may be performed before actual recording. Select the peak reduction mode in recording standby, and maximize the input level. As a test performance is given subsequently, the input gain is reduced to an appropriate level to meet the input signals, and an optimum input level for the performance is set.

Recording will be stored at this input level if this mode is disabled before starting recording. Otherwise, the input level will continue to be controlled automatically during recording.

■ LIMITER

This function prevents distortion due to a sudden and excessive input.

This mode is also suited for recording of live performances with large volume changes.

In this mode, you can change the input level manually even during recording.

CAUTION

Distortion of sounds may occur when excessively large input signals come in even if the LIMITER function is activated. If this occurs, reduce the input level manually or move the unit farther away from the sound source.

Record in 4CH mode (4CH mode only)

You can connect built-in microphones to external microphones or other equipment to record four independent channels.

Mono × 1–4

Channels 1, 2, 3 and 4

Stereo × 1–2

Channels 1/2 and 3/4

Stereo × 1 + Mono × 1–2 (WAV or BWF only)

Channels 1/2, channel 3 and channel 4

Channel 1, channel 2 and channels 3/4

Record 4 channels

1. Set the mode to 4CH mode. (See “Selecting Operation Mode” on page 17.)
2. Press the **RECORD** button to set the recording standby mode.
3. Select the channel (track) you want to record by using the **TRACK/INPUT** button.
At this point, for the channel (track) you want to record into a stereo file, turn the stereo link on. A channel (track) not stereo-linked is recorded into a mono file.
4. Press the **RECORD** button again to start recording.
5. Press the **■/HOME** button to stop recording.

■ How to Set the Stereo Link

- **Turn the stereo link for channel 1 and channel 2 on/off.**
When in recording standby, press **TRACK/INPUT** button 1 and button 2 at the same time.
- **Turn the stereo link for channel 3 and channel 4 on/off.**
When in recording standby, press **TRACK/INPUT** button 3 and button 4 at the same time.

You can check the status of the stereo link from the channel (track) status display in the screen display.

The stereo link can be set for the above combinations only.

NOTE

*When the **FORMAT** item on the **REC SETTING** screen is set to **MP3**, recording a combination of mono and stereo files is not possible.*

File names when recording in 4-channel

In 4-channel recording, the following files are created.

If they are stereo-linked, files are created in sets for the built-in mic (channels 1/2) and external device (channels 3/4).

TASCAM_0001S12.WAV
① ② ③ ④

- ①: Set with the **WORD** item on the **FILE NAME** screen.
- ②: Recording file base number
- ③: 5 is the source file
- ④: Assigned channels (1 is channel 1, 12 is channels 1/2 and 34 is channels 3/4)

4 – Recording

Record in MTR mode (MTR mode only)

You can use this device as a multitrack recorder (MTR) to record individual tracks and overdub them.

A maximum of four channels can be recorded simultaneously from the built-in mics and external input jacks (input jack assignments can be selected). These can also be recorded into already recorded files (overdubbing).

Recorded files are saved as mono x 4.

1. Set the mode to **MTR** mode. (See “Selecting Operation Mode” on page 17.)
2. Select the track you want to record by using the **TRACK/INPUT** button.
The track selected here goes into recording standby mode.
3. Press the **RECORD** button to start recording.
4. Press the **■/HOME** button to stop recording.

NOTE

In MTR mode, you can punch in and out as well as bounce tracks. (See “Punching in/out (MTR mode only)” on page 29.) (See “Track bounce (MTR mode only)” on page 45.)

Switch files during recording (track increment, available in 4CH mode only)

During recording, you can stop recording to the current file either manually or automatically at a set time, and continue to record to a new file (the track increment function).

Manual track increment during recording

During recording, you can easily update a file manually and continue to make recording.

1. Press the **▶▶I** button during recording.

NOTE

Numbers at the end of file name will increment each time when a new file is created.

CAUTION

- The maximum total number of folders and files you can create is 5,000.
- Files with a recording time of less than two seconds cannot be created. Moreover, if the sampling frequency is 96 kHz, files shorter than four seconds cannot be created.
- When the name of a new file to be created already exists, the number will be incremented further.

Automatic track increment at specified time

During recording, the DR-44WL will automatically switch recording from the current file to a new file when it reaches a certain time specified in the **TRACK INC** of the **AUTO FUNCTION** screen.

Follow the below steps to set the maximum time for automatic increment:

1. Press the **MENU** button to open the **MENU** screen.
2. Using the **wheel**, select (highlight) **AUTO FUNCTION** and press the **ENTER/MARK** or **▶▶I** button.
AUTO FUNCTION screen is displayed.
3. Using the **wheel**, select (highlight) **TRACK INC** and press the **ENTER/MARK** or **▶▶I** button.

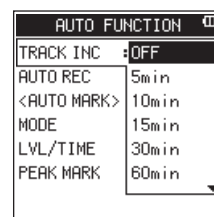

4. Use the **wheel** to select the automatic track increment time.
Options: **OFF** (default value), **5min**, **10min**, **15min**, **30min**, **60min**
5. Press the **ENTER/MARK** button to confirm the setting and enable selection of other setting items.
6. Once the setting has been completed, press the **■/HOME** button to return to the Home screen.

CAUTION

The maximum total number of folders and files you can create is 5,000.

Recording automatically (AUTO REC) (4CH mode only)

When the auto record function is on, the unit can start and pause recording and create new files automatically in response to input sound levels.

1. Press the **MENU** button to open the MENU screen.
2. Using the **wheel**, select (highlight) **AUTO FUNCTION** and press the **ENTER/MARK** or **▶▶** button. **AUTO FUNCTION** screen is displayed.
3. Using the **wheel**, select (highlight) **AUTO REC** and press the **ENTER/MARK** or **▶▶** button.

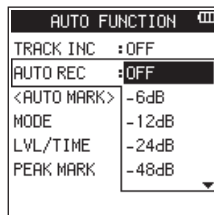

4. Use the **wheel** to select a start level that activates the AUTO REC function (a level that recognizes incoming signals). Options: OFF (default value), -6dB, -12dB, -24dB, -48dB
5. Press the **ENTER/MARK** button to confirm the setting and enable selection of other setting items.
6. Once the setting has been completed, press the **■/HOME** button to return to the Home screen.
7. Press the **RECORD** button to set to the mode in which the channel (track) is selected for recording.
8. Select the channel (track) you want to record by using the **TRACK/INPUT** button.
At this point, for the channel (track) you want to record into a stereo file, turn the stereo link on. A track not stereo-linked is recorded into a mono file.
9. Press the **RECORD** button to set the recording standby mode.
Recording starts automatically when the input signal exceeds the threshold set in the **AUTO REC** item.

NOTE

- When in recording standby, the **RECORD** indicator flashes faster than when recording.
 - When recording, if the input signal level falls below the level set with the **AUTO REC** item for more than 5 seconds, the unit pauses recording and creates a new file. When the input signal level becomes higher than the set level again, it starts recording to a new file.
 - When new files are created, incremental numbers are added to the end of each file name.
10. Press the **■/HOME** button to stop recording.

CAUTION

- When the auto record function is on the self-timer cannot be used.
- The maximum total number of folders and files you can create is 5,000.
- Files with a recording time of less than two seconds cannot be created. Moreover, if the sampling frequency is 96 kHz, files shorter than four seconds cannot be created.
- When the name of a new file to be created already exists, the number will be incremented further.

TIPS

By using this in combination with the **PRE REC** function, you can record events without losing the beginnings of sounds.

Start recording a moment before pressing RECORD (PRE REC, 4CH mode only)

By using prerecording, when the unit is in recording standby you can record up to two seconds of the signal input before the **RECORD** button is pushed to start recording. (**PRE REC**)

1. Press the **MENU** button to open the MENU screen.
2. Using the **wheel**, select (highlight) **REC SETTING** and press the **ENTER/MARK** or **▶▶** button. The **REC SETTING** screen appears.
3. Using the **wheel**, select (highlight) **PRE REC** and press the **ENTER/MARK** or **▶▶** button.

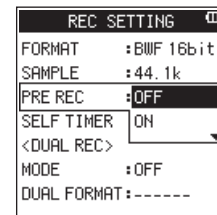

4. Using the **wheel**, turn the **PRE REC** function on or off. Options: OFF (default value), ON
Press the **ENTER/MARK** button to confirm the setting and enable selection of other setting items.
5. Once the setting has been completed, press the **■/HOME** button to return to the Home screen.

TIPS

By combining **PRE REC** with the **AUTO REC** function, you will not miss an opportunity to start recording.

NOTE

If you start recording within two seconds from when the record standby mode is turned ON, recording will begin from the record standby mode.

4 – Recording

Self-timer function

Similar to a camera, the DR-44WL has a self-timer function to begin recording after a set period of time.

1. Press the **MENU** button to open the MENU screen.
2. Using the **wheel**, select (highlight) REC SETTING and press the **ENTER/MARK** or **▶▶** button.

The REC SETTING screen appears.

3. Using the **wheel**, select (highlight) SELF TIMER and press the **ENTER/MARK** or **▶▶** button.

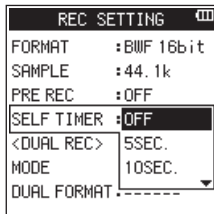

4. Use the **wheel** to set the waiting time to start recording. Options: OFF (default value), 5SEC., 10SEC.
5. Press the **ENTER/MARK** button to confirm the setting and enable selection of other setting items.
6. Once the setting has been completed, press the **■/HOME** button to return to the Home screen.
7. Press the **RECORD** button to set the recording standby mode. The self-timer icon  appears on the recorder status screen, and the time is displayed on the right.
8. Press the **RECORD** button. Recording will start after the set time period.

NOTE

- The self-timer function will not work when recording is paused during recording.
- The self-timer function and the AUTO REC function cannot be used together.
- When in MTR mode, if the AUTO PUNCH item on the AUTO FUNCTION screen is ON, the AUTO PUNCH function will be given priority.

Simultaneously recording two files with different input levels/formats (DUAL REC, 4CH only)

This recorder can simultaneously record a second recording at a different input level along with the regular recording. For example, when recording with microphones, you can make an ordinary recording with the input level set as high as possible and simultaneously record at a slightly lower input level for safety.

Recorded files are saved as two files: one recorded at the input level of ordinary recording and the other recorded at an input level 12dB lower than that level. In addition, you can record in two different formats (WAV and MP3) simultaneously and create two files.

NOTE

- Make the input level setting for the ordinary recording in the usual manner. (See "Adjusting the input level" on page 19.) (See "Set the input gain" on page 19.)
- You cannot apply effects to the second file, which is recorded at a different input level or in a different format.

Enabling dual recording

1. Press the **MENU** button to open the MENU screen.
2. Using the **wheel**, select (highlight) REC SETTING and press the **ENTER/MARK** or **▶▶** button. The REC SETTING screen appears.
3. Using the **wheel**, select (highlight) MODE and press the **ENTER/MARK** or **▶▶** button.

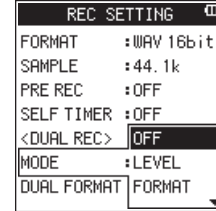

4. Use the **wheel**, to set the recording mode for dual recording.

Options	Detail
OFF (default value)	Record in ordinary stereo mode.
LEVEL:	Record at two different levels.
FORMAT	Record in two different formats (WAV and MP3).

5. Press the **ENTER/MARK** button to confirm the setting and enable selection of other setting items.
6. When FORMAT is selected for the recording mode, move on to the next step. When an item other than FORMAT is selected, press the **■/HOME** button to return to the Home screen.
7. Using the **wheel**, select (highlight) FORMAT and press the **ENTER/MARK** or **▶▶** button.

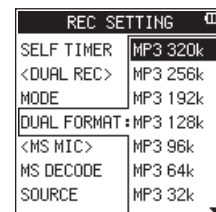

8. Use the **wheel** to set the MP3 format for dual recording.
Options: MP3 320k, MP3 256k, MP3 192k, MP3 128k, MP3 96k, MP3 64k, MP3 32k
9. Press the **ENTER/MARK** button to confirm the setting and enable selection of other setting items.
10. Once the setting has been completed, press the **■/HOME** button to return to the Home screen.

NOTE

- The WAV file format is the setting in ordinary recording.
- DUAL FORMAT can be selected only when the recording format is WAV or BFW, 44.1kHz and 16 bits or 48 kHz and 16 bits.
- With dual recording, two tracks can be recorded for a stereo file or one track can be recorded for a mono file. Multiple channels (tracks) cannot be selected as dual recording sources.

Starting dual recording

1. Press the **RECORD** button to enter recording standby, and use the **TRACK/INPUT** buttons to select the channels (tracks) that you want to record.
2. Press the **RECORD** button to start dual recording.
During dual recording, the recording screen appears as follows.

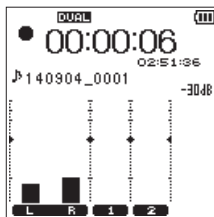

In the input source display area of the recording screen, the input levels of the current input source and of the second file for dual recording are shown.

Dual recording file names

Dual recording allows two files to be created simultaneously. The name of the second file created by dual recording has “_D” added to the name of the file recorded ordinarily.

TASCAM_0002S12.WAV

① ② ③ ④

TASCAM_0002S12_D.WAV

① ② ③ ④ ⑤

- ①: Set with the **WORD** item on the **FILE NAME** screen.
- ②: Recording file base number
- ③: 5 is the source file
- ④: Assigned channels (12 is channels 1/2 and 34 is channels 3/4)
- ⑤: D is the dual recording file

Create cue marks during recording

In recording or recording standby mode, the DR-44WL can create cue marks to a file to quickly locate the marked position and start playback. (See “How to download and install the exclusive application (DR CONTROL)” on page 53.)

You can either manually set the cue mark, or automatically set the cue mark level or time to minimize the operation noise.

NOTE

The unit will not move to the cue mark position in recording or recording standby mode.

Manual cue marking during recording

Press the **ENTER/MARK** button during recording or recording standby to create a cue mark.

The registered pull-up cue mark no. message will appear at the bottom of the screen display.

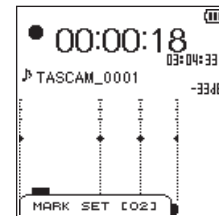

NOTE

- Up to 99 cue marks can be created and stored in each file.
- Cue marks that are created during the recording of WAV file in BWF format by this unit are stored in the file. You can use the cue marks in softwares compatible with BWF format.
- MARK SET [XX]* is added to the mark name.
* [XX] is a serial number common to all marks.

4 – Recording

Add cue marks automatically during recording

When you turn the AUTO MARK function ON, cue marks can be added automatically according to the operating level and time.

■ Add cue marks automatically according to set levels

1. Press the **MENU** button to open the MENU screen.
2. Using the **wheel**, select (highlight) AUTO FUNCTION and press the **ENTER/MARK** or **▶▶** button.
AUTO FUNCTION screen is displayed.
3. Using the **wheel**, select (highlight) MODE for AUTO MARK and press the **ENTER/MARK** or **▶▶** button.
4. Use the **wheel** to set the automatic cue mark mode to LEVEL.

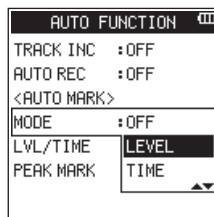

Options: OFF (default value), LEVEL, TIME

5. Press the **ENTER/MARK** button to finalize the set mode.
6. Using the **wheel**, select (highlight) LVL/TIME for AUTO MARK and press the **ENTER/MARK** or **▶▶** button.

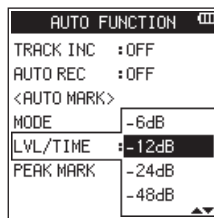

7. Use the **wheel** to set a level to automatically add cue marks.
Options: -6dB, -12dB (default value), -24dB, -48dB
8. Press the **ENTER/MARK** button to finalize the set mode.
9. Once the setting has been completed, press the **■/HOME** button to return to the Home screen.

■ Add cue marks automatically according to set time

1. Press the **MENU** button to open the MENU screen.
2. Using the **wheel**, select (highlight) AUTO FUNCTION and press the **ENTER/MARK** or **▶▶** button.
AUTO FUNCTION screen is displayed.
3. Using the **wheel**, select (highlight) MODE for AUTO MARK and press the **ENTER/MARK** or **▶▶** button.
4. Use the **wheel** to set the automatic cue mark mode to TIME.

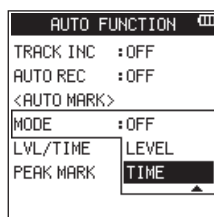

5. Press the **ENTER/MARK** button to finalize the set mode.

6. Using the **wheel**, select (highlight) LVL/TIME for AUTO MARK and press the **ENTER/MARK** or **▶▶** button.

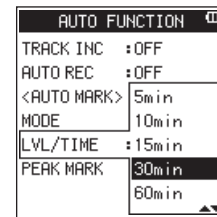

7. Use the wheel to set a time to automatically add cue marks.
Options: 5min, 10min, 15min, 30min, 60min (default value)
8. Press the **ENTER/MARK** button to finalize the set time.
9. Once the setting has been completed, press the **■/HOME** button to return to the Home screen.

■ Adding marks automatically when the PEAK indicator lights

1. Press the **MENU** button to open the MENU screen.
2. Use the **wheel** to select AUTO FUNCTION, and press the **ENTER/ MARK** or **▶▶** button.
The AUTO FUNCTION screen opens.
3. Use the **wheel** to select the PEAK MARK item under AUTO MARK, and press the **ENTER/MARK** or **▶▶** button.

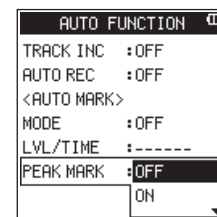

4. Use the **wheel** to turn the PEAK MARK function ON.
Options: OFF (default), ON
5. Press the **ENTER/MARK** button to confirm the setting and reenables setting item selection.
6. When finished making the setting, press the **■/HOME** button to return to the Home Screen.

NOTE

- Marks are added two seconds before a PEAK indicator lights.
- For 10 seconds after a mark is added because a PEAK indicator lit, no other mark will be added if the PEAK indicator lights again or an automatic mark would normally be added according to the LEVEL setting.
- Marks added because of a PEAK indicator lighting will not cause division when the automatic division function is used.

Moving to the cue mark position

During pause, you can move to a cue mark registered in the selected file. When multiple cue marks exist, you will move to the nearest cue mark to the present cue mark.

You can use this function to go to the beginning of a song, similar to an index.

1. During pause or playback, while pressing the **ENTER/MARK** button, press the **◀◀** button or the **▶▶** button.

NOTE

You cannot move to a cue mark of a different file.

Use MS microphone

The unit is provided with the MS decoder; you can record or play tracks using the MS microphone.

1. Press the **MENU** button to open the MENU screen.
2. Using the **wheel**, select (highlight) **REC SETTING** and press the **ENTER/MARK** or **▶▶I** button.

The **REC SETTING** screen appears.

3. Using the **wheel**, select (highlight) **MS DECODE** and press the **ENTER/MARK** or **▶▶I** button.

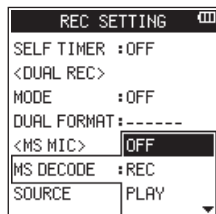

4. Use the **wheel** to set the decoding mode when using a mid-side microphone.

Options	Detail
OFF (default value)	Record in ordinary stereo mode.
REC	Use to decode while recording. Playback is conducted without decoding.
PLAY	Record mid-side microphone output without decoding for decoding later. Use this mode to monitor when recording with a mid-side microphone. Use this also when playing back mid-side files that were recorded without decoding.

5. Press the **ENTER/MARK** button to confirm the setting and enable selection of other setting items.
6. Using the **wheel**, select (highlight) **SOURCE** and press the **ENTER/MARK** or **▶▶I** button.

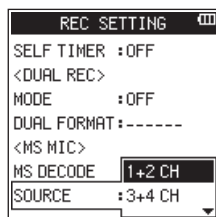

7. Use the **wheel** to set the channel to use a mid-side microphone for.
Options: 1+2 CH, 3+4 CH (default value)
8. Press the **ENTER/MARK** button to confirm the setting and enable selection of other setting items.
9. Once the setting has been completed, press the **■/HOME** button to return to the Home screen.

NOTE

A mid-side mic can be used in the following circumstances.

- In 4CH mode, when a mid-side mic is input through the **EXT MIC/LINE IN** jack and when this unit is playing back an external file recorded using a mid-side mic
- In MTR mode, when a mid-side mic is input through the **EXT MIC/LINE IN** jack (channel can be changed using **INPUT**)

Punching in/out (MTR mode only)

Punching in and out is a technique used to replace parts of already recorded tracks.

Punching in/out manually

You can start playback of recording, switch to recording when it reaches the part to be replaced (punch in), and then switch back to playback (or stop) when the end of that part is reached (punch out).

1. Set the operation mode to **MTR**. (See “Selecting Operation Mode” on page 17.)
2. Determine the part you want to replace in advance.
Select a point where the replacement audio can be combined well with the original track audio.
3. Press the **TRACK/INPUT** button for the track with the part to be replaced to enter recording standby (**RECORD** indicator flashes).
4. Press the **▶/II** button again to restart playback before the part to be replaced.
5. When the part to be replaced is reached, press the **RECORD** button to switch to recording (punch in).
6. When the end of the part to be replaced is reached, press the **■/HOME** button to switch to playback (punch out).

Punching in/out automatically (AUTO PUNCH)

Use this function to start (punch in) and stop (punch out) recording automatically when set **IN** (starting) and **OUT** (ending) points are reached.

1. Set the operation mode to **MTR**. (See “Selecting Operation Mode” on page 17.)
2. Set the **IN** (starting) and **OUT** (ending) points of the loop on the **PLAY FUNCTION** screen. (See “Repeated Playback of Selection (Loop Playback)” on page 39.)
3. Press the **■/HOME** button to return to the Home Screen.
4. Press the **MENU** button to open the MENU screen.
5. Use the wheel to select **AUTO FUNCTION** and press the **ENTER/MARK** or **▶▶I** button to open the **AUTO FUNCTION** screen.
6. Use the wheel to select **AUTO PUNCH** and press the **ENTER/MARK** or **▶▶I** button.

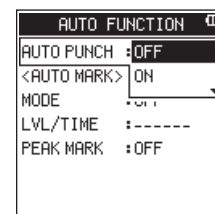

7. Use the wheel to select **ON** and press the **ENTER/MARK** button.
Options: OFF (default value), ON

4 – Recording

8. After you complete the setting, press the **■/HOME** button to return to the Home Screen.

When the **AUTO PUNCH** function is on, the **A.PUNCH** icon appears at the top of the Home Screen.

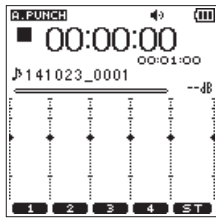

9. Press the **TRACK/INPUT** buttons for the tracks that you want to record.
10. Press the **RECORD** button to start playback. Recording will start when the IN (starting) point set in step 1 is reached. Recording will stop when the OUT (ending) point set in step 1 is reached.

Recording duration

The table below shows the maximum recording time per file format for SD/SDHC/SDXC cards:

File format (recording setting)		SD/SDHC/SDXC cards capacity				
		1GB	4GB	8GB	32GB	
WAV/BWF 16 bit (STEREO)	44.1kHz	1 hour 34 minutes	6 hour 17 minutes	12 hour 35 minutes	50 hour 23 minutes	
	48kHz	1 hour 26 minutes	5 hour 47 minutes	11 hour 34 minutes	46 hour 17 minutes	
	96kHz	43 minutes	2 hour 53 minutes	5 hour 47 minutes	23 hour 08 minutes	
WAV/BWF 24 bit (STEREO)	44.1kHz	1 hour 02 minutes	4 hour 11 minutes	8 hour 23 minutes	33 hour 35 minutes	
	48kHz	57 minutes	3 hour 51 minutes	7 hour 42 minutes	30 hour 51 minutes	
	96kHz	28 minutes	1 hour 55 minutes	3 hour 51 minutes	15 hour 25 minutes	
MP3 (STEREO/MONO)	32 kbps	44.1kHz/48kHz	69 hour 26 minutes	277 hour	555 hour	2222 hour
	64 kbps	44.1kHz/48kHz	34 hour 43 minutes	138 hour	277 hour	1111 hour
	96 kbps	44.1kHz/48kHz	23 hour 08 minutes	92 hour 35 minutes	185 hour	740 hour
	128 kbps	44.1kHz/48kHz	17 hour 21 minutes	69 hour 26 minutes	138 hour	555 hour
	192 kbps	44.1kHz/48kHz	11 hour 34 minutes	46 hour 17 minutes	92 hour 35 minutes	370 hour
	256 kbps	44.1kHz/48kHz	8 hour 40 minutes	34 hour 43 minutes	69 hour 26 minutes	277 hour
	320 kbps	44.1kHz/48kHz	6 hour 56 minutes	27 hour 46 minutes	55 hour 33 minutes	222 hour

- The recording times shown above are theoretical values. They might differ depending on the SD, SDHC, and SDXC cards in use.
- The recording times shown above are not continuous recording times, but they are the total possible recording times for the SD, SDHC, and SDXC cards.
- If the recording time exceeds 24 hours, a new file will be created automatically and recording will continue without pause.
- Mono recording in WAV format will double the maximum recording times specified above.
- For DUAL REC recording in the WAV/BWF format and 4-channel recording, the maximum recording time will be half the figures above.

5 – Operating Files and Folders (4CH Mode Only)

In the **BROWSE** screen, you can browse the **MUSIC** folder (stores audio files), delete files and folders, or create a new folder in the SD card.

TIPS

*You can also connect the unit with a computer via USB, or directly insert the SD card to the computer to change the configuration of folders or delete files in the **MUSIC** folder also from the computer. In addition, you can edit file names from the computer.*

To open the **BROWSE** screen, press the **MENU** button to open the **MENU** screen. Use the **wheel** to select (highlight) **BROWSE** and press the **ENTER/MARK** or **▶▶** button.

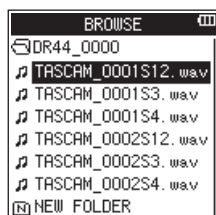

Displayed in this screen are the contents of the folder containing the file selected on the Home screen before the **BROWSE** screen was opened.

Screen navigation

Folders and music files are displayed in a layered-tree type in the **BROWSE** screen.

The DR-44WL can create up to two layers in each folder.

- Use the **wheel** to select (highlight) a file or folder.
- When a folder is selected (highlighted), press the **▶▶** button to show the contents of that folder.
- When a file for folder is selected (highlighted), press the **◀◀** button to move one level upward.
- When a file or folder is selected (highlighted), press the **QUICK** button to open the **QUICK** pop-up menu.
- When a file is selected, press the **ENTER/MARK** or **▶▶** button to return to the Home Screen and load the file. The folder that contains this file becomes the current folder (the currently selected folder), and recorded files will be saved to this folder.
- When a file is selected, press the **▶/||** button to return to the Home Screen and play the file.
- When a folder is selected, press the **ENTER/MARK** button to return to the Home screen and load the first file in that folder. This folder becomes the current folder (the currently selected folder), and recorded files will be saved to this folder.

Icons on the BROWSE screen

The meanings of icons that appear on the **BROWSE** screen are as follows.

■ MUSIC folder (🎵)

In the **BROWSE** showing the **ROOT** level, the **MUSIC** folder is displayed at the top.

■ Audio file (🎵)

This icon **🎵** appears before the name of a music file.

■ Folder (📁)

This folder contains a sub-folder.

■ Folder (📁)

This folder contains no sub-folder.

■ Folder in display (📁)

Contents of this folder is currently in display.

■ New folder (📁)

A new folder will be created.

File operations

Select (highlight) the desired audio file in the **BROWSE** screen, and press the **QUICK** button to open the following **QUICK** pop-up menu.

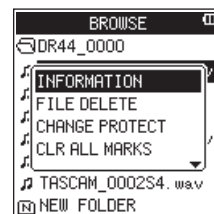

Use the **wheel** to select (highlight) an item, and press the **ENTER/MARK** button. Either of the following actions will start according to the selected item.

■ INFORMATION

Information about the selected file (date/time, size) will pop up.

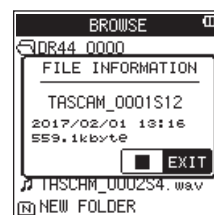

Press the **■/HOME** button again to return to the **BROWSE** screen.

5 – Operating Files and Folders (4CH Mode Only)

■ FILE DELETE

A pop-up message appears to confirm that the deletion of the selected file.

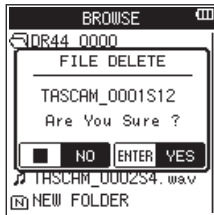

Press the **ENTER/MARK** button to delete the file, and press the **■/HOME** button to cancel the delete operation.

■ Protecting files (4CH mode only)

This function protects files to change them to read-only.

1. Select a file to protect on the **BROWSE** screen.
2. Press the **QUICK** button to open the quick menu pop-up, and use the wheel to select **CHANGE PROTECT**.

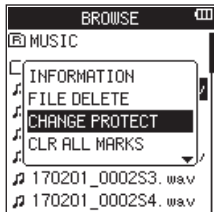

3. Press the **ENTER/MARK** button.
A **SET PROTECT** pop-up message appears to confirm that you want to protect the selected file.
If the file has already been protected, **REMOVE PROTECT** will appear instead.

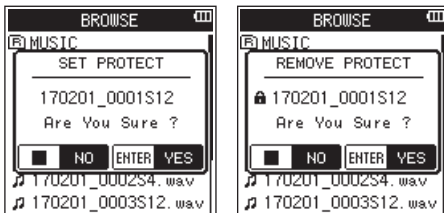

4. Press the **ENTER/MARK** button to protect the file and return to the **BROWSE** screen. If the file has already been protected, this will remove protection from it before returning to the **BROWSE** screen.

Press the **■/HOME** button to cancel changing the protection status and return to the **BROWSE** screen.

NOTE

- All other files in the same project as the protected file will also be protected.
- Use the **INFORMATION** item in the **BROWSE** screen quick menu to check protection status.

■ Clearing all marks (4CH mode only)

1. Select the file for which to clear all marks on the **BROWSE** screen.
2. Press the **QUICK** button to open the quick menu pop-up, and use the wheel to select **CLR ALL MARKS**.

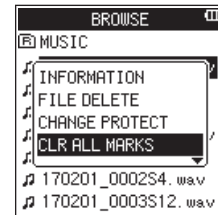

3. Press the **ENTER/MARK** button.
The following confirmation pop-up message appears.

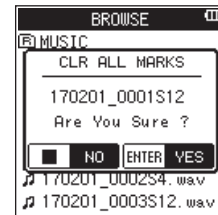

4. Press the **ENTER/MARK** button to clear the marks and return to the **BROWSE** screen.
Press the **■/HOME** button to cancel clearing the marks and return to the **BROWSE** screen.

Folder operations

Select the desired folder on the **BROWSE** screen and press the **QUICK** button to open the **QUICK** pop-up menu that is shown below.

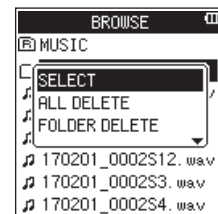

Use the **wheel** to select (highlight) an item, and press the **ENTER/MARK** button. Either of the following actions will start according to the selected item.

■ SELECT

Returns to the Home screen and selects the first file in the folder. In addition, the recorded files are saved in the selected folder.

■ ALL DELETE

A pop-up message will appear to confirm deletion of all files in the selected folder.

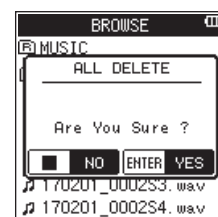

Press the **ENTER/MARK** button to delete the files, and press the **■/HOME** button to cancel the delete operation.

5 – Operating Files and Folders (4CH Mode Only)

NOTE

- Read-only files and unrecognized files by the DR-44WL will not be deleted.
- Files on different levels of the selected folder will not be deleted.
- To delete all the files in the root folder (MUSIC) at the same time, move to the top level in the BROWSE screen, select the MUSIC folder and selects ALL DELETE from the Quick menu.

■ Deleting empty folders (4CH mode)

1. Select the empty folder that you want to delete on the BROWSE screen.
2. Press the **QUICK** button to open the quick menu pop-up, and use the wheel to select FOLDER DELETE.

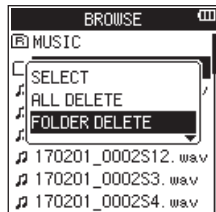

3. Press the **ENTER/MARK** button.
The following confirmation pop-up message appears.



NOTE

If the folder is not empty, a NOT EMPTY pop-up message will appear.

4. Press the **ENTER/MARK** button to delete the empty folder and return to the BROWSE screen.
Press the **■/HOME** button to cancel deleting the folder and return to the BROWSE screen.

Creating a new folder

A NEW FOLDER is available at the bottom of each folder.

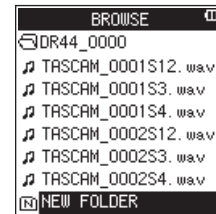

1. Select (highlight) NEW FOLDER, and press the **ENTER/MARK** or **▶▶** button to confirm creation of a new folder.

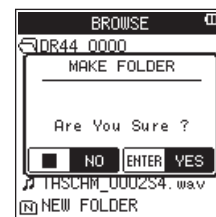

2. Press the **ENTER/MARK** button to create a new folder.
Press the **■/HOME** button to cancel creation of a new folder.

NOTE

The DR-44WL is not designed to handle folders with three or more layers, and therefore the NEW FOLDER does not exist in a folder with two layers.

A newly created folder becomes the current folder (currently selected folder), and recorded files are saved in this folder.

6 – Managing Songs (MTR Mode only)

In the MTR mode of this recorder, one track (recording data group) is treated as one song and data is managed on a song basis. For one song, four tracks and a master file after mixing down are saved.

To record or create music, a song being created needs to be loaded or a new song needs to be created.

This chapter describes basic operations such as a method for loading songs and a procedure for creating new songs as well as various functions to manage songs.

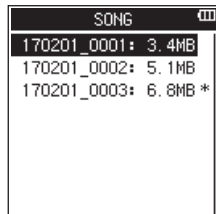

Song Operation

Select (highlight) the desired song file on the SONG screen, and press the **QUICK** button to open the QUICK pop-up menu below.

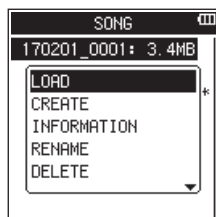

Use the wheel to select (highlight) the desired item, and press the **ENTER/MARK** button. Then, the unit operates as follows:

■ LOAD

Loads the selected song.

■ CREATE

Creates a new song.

■ INFORMATION

Information about the selected song (date/time, size) will pop up.

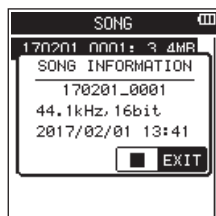

■ RENAME (V1.10 supported)

Edits the name of the selected song.

■ DELETE

Deletes the selected song.

Loading Songs

Use the following procedure to load the song you want.

1. Set the mode to **MTR** mode. (See "Selecting Operation Mode" on page 17.)
2. Press the **MENU** button when the recorder is stopped to open the **MENU** screen.
3. Using the **wheel**, select (highlight) **SONG** and press the **ENTER/MARK** or **▶▶** button.
The **SONG** screen will be displayed.

NOTE

*The * icon appears for a song currently being loaded.*

4. Use the **wheel** to select (highlight) the desired song and press **QUICK** to open the QUICK pop-up menu below.

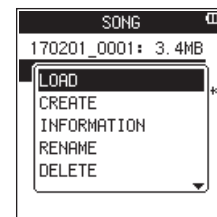

NOTE

*After selecting (highlighting) the desired song, press the **ENTER/MARK** button to load the selected song and return to the Home screen.*

5. Using the **wheel**, select (highlight) **LOAD** and press the **ENTER/MARK** button.
The selected song will be loaded, and the pop-up will disappear.
The icon * will move to the selected song.

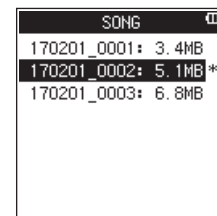

6. Press the **■/HOME** button to return to the Home screen.

6 – Managing Songs (MTR Mode only)

Creating a New Song

Use the following procedure to create a new song.

1. Set the mode to **MTR** mode. (See “Selecting Operation Mode” on page 17.)
2. Press the **MENU** button when the recorder is stopped to open the **MENU** screen.
3. Using the **wheel**, select (highlight) **SONG** and press the **ENTER/MARK** or **▶▶** button.
The **SONG** screen will be displayed.
4. Press the **QUICK** button to open the **QUICK** pop-up menu and use the **wheel** to select (highlight) **CREATE**.

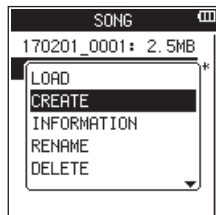

5. Press the **ENTER/MARK** button to open the **QUICK** pop-up menu for setting the format for a new song.



6. Use the **wheel** to set the format of the new song.
Options: 44.1kHz - 16bit (default), 44.1kHz - 24bit, 48kHz - 16bit, 48kHz - 24bit
7. Press the **ENTER/MARK** button to create the new song.
Press the **■/HOME** button to return to the **SONG** screen.

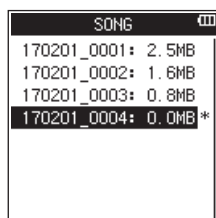

NOTE

*The song to be created will be named according to the settings of the **TYPE** item on the **FILE NAME** screen.*

8. Edit the name (title) of the song as necessary. (See “Song Operation” on page 35.)

TIPS

*The song name (title) can also be edited later using **RENAME** in the **QUICK** menu. The song name can also be edited when saving the song.*

9. Press the **■/HOME** button to return to the Home screen.

NOTE

The “MTR” folder must always contain at least one song. For this reason, when you insert or format an SD card, for example, a new song will be created.

Changing the Song Name

Use the following procedure to change the song name.

1. Set the mode to **MTR** mode. (See “Selecting Operation Mode” on page 17.)
2. Press the **MENU** button when the recorder is stopped to open the **MENU** screen.
3. Using the **wheel**, select (highlight) **SONG** and press the **ENTER/MARK** or **▶▶** button.
The **SONG** screen will be displayed.
4. Use the **wheel** to select the song with the name you want to change.
5. Press the **QUICK** button to open the quick pop-up menu, and use the wheel to select **RENAME**.

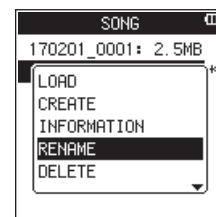

6. When the **ENTER/MARK** button is pressed, the **SONG RENAME** screen for changing the song name will pop up.

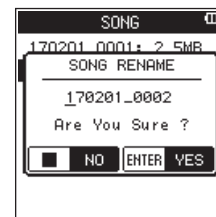

7. Use the **◀◀** button and the **▶▶** button to move the cursor and use the wheel to change the text.
8. Press the **ENTER/MARK** button to confirm the song name and return to the **SONG** screen.
9. Press the **■/HOME** button to return to the Home screen.

Deleting songs

You can delete songs. We recommend deleting unnecessary songs when the SD card space is low.

1. Set the mode to **MTR** mode. (See “Selecting Operation Mode” on page 17.)
2. Press the **MENU** button when the recorder is stopped to open the **MENU** screen.
3. Using the **wheel**, select (highlight) **SONG** and press the **ENTER/MARK** or **▶▶|** button.
The **SONG** screen will be displayed.
4. Use the **wheel** to select the song that you want to delete.
5. Press the **QUICK** button to open the quick pop-up menu, and use the wheel to select **DELETE**.

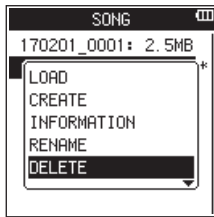

6. Press the **ENTER/MARK** button to delete the selected song and return to the **SONG DELETE** screen.



7. Press the **ENTER/MARK** button to delete the selected song.
8. Press the **■/HOME** button to return to the Home screen.

NOTE

The “MTR” folder must always contain at least one song. For this reason, when you insert or format an SD card, for example, a new song will be created.

7 – Playback

Playback

When playback is stopped on the Home screen, press the ►/|| button to start playing.

NOTE

You can also choose files for playback by name on the BROWSE screen.

Pausing

Press the ►/|| button to pause playback at the current position (pause) when playing a track on the Home screen. Press the ►/|| button again to resume playback from the previous position

Stopping

When you press ■/HOME button while a track is being played back on the Home screen, the playback is paused.

Press ■/HOME button again to stop playback at the beginning of a file.

Fast-rewinding and fast-forwarding (search)

During playback when the Home screen is open, press and hold the ◀◀/▶▶ button to search backward/forward.

NOTE

Press and hold the ◀◀ button or ▶▶ button to increase the search speed.

Moving the playback position

Use the **wheel** to move the playback position while the playback is stopped or paused on the Home screen.

After you have moved the playback position, the playback is paused.

Selecting a playback file (skip)

When the Home screen is open, press the ◀◀ button or the ▶▶ button to select the file you want to play.

When you press the ◀◀ button while playback of the file is in progress, it will return to the beginning of the file. When you press the ◀◀ button, it will skip to the beginning of the previous file.

To skip to the next file, press the ▶▶ button at the beginning of in the middle of a file.

NOTE

- *The track name, file number and other file information for the currently playing track appear on the display.*
- *When playback was stopped at the beginning of a file, the status ■ icon will appear on the screen. When playback was stopped in the middle of a file, the status || icon will appear on the screen.*
- *To move a file, press the ◀◀ button or ▶▶ button repeatedly as many times as needed.*

Special Playback Control Functions

Using the unit's playback control functions, you can play back a selected section of a track repeatedly. You can also change the playback speed without changing the pitch or change the pitch without changing the playback speed.

You can use these playback control functions to practice and learn musical passages effectively.

Playback Control Screen

Use the PLAY FUNCTION screen to set the playback control functions. Loop playback, playback speed change, and key change can be made in this mode.

Set the playback control functions using the following method.

1. While the Home screen is open and the unit is stopped, paused, or playing back, press **QUICK** to open the QUICK pop-up menu.
2. Using the wheel, select (highlight) **PLAY FUNCTION** and press **ENTER/MARK** button.

The **PLAY FUNCTION** screen is displayed.

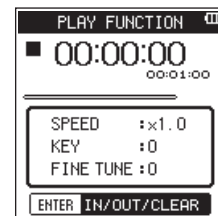

3. Press the **QUICK** button to open the **PLAY FUNCTION** screen Quick pop-up menu.

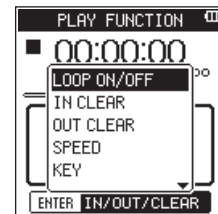

LOOP ON/OFF

Use to turn loop playback on and off. (See "Repeated Playback of Selection (Loop Playback)" on page 39.)

IN CLEAR

This clears only the loop IN (starting) point. (See "Clearing IN and OUT points only" on page 39.)

OUT CLEAR

This clears only the loop OUT (ending) point. (See "Clearing IN and OUT points only" on page 39.)

SPEED

Open a pop-up where you can change the playback speed. (See "Changing the playback speed (VSA)" on page 39.)

KEY

Open a pop-up where you can change the key. (See "Key control playback" on page 40.)

FINE TUNE

Open a pop-up where you can change the key. (See "Key control playback" on page 40.)

4. Use the wheel to select a Quick menu item and press the **ENTER/MARK** button.
5. After you finish making settings on this screen, press the ■/HOME button to return to the Home screen.

Repeated Playback of Selection (Loop Playback)

With this function, you can continuously repeat (loop) the playback of a selection that you make.

- When the **PLAY FUNCTION** screen is open, press the **▶/||** button to start playback, and press **ENTER/MARK** button at the start point of the section that you want to start loop playback.



This position is set as IN (start) point.

The **■** icon will light up at the playback position under the playback indicator bar.

- Press **ENTER/MARK** button at the end point of the section that you want to start loop playback.



This position is set as OUT (end) point, and the unit will playback the section between the loop playback IN and OUT points.

The **■** icon will light up at the playback position under the playback indicator bar.

During loop playback, the **⏮** icon lights up under the recording status indicator.

Press the **■/HOME** button return to the Home screen while maintaining the IN (start) and OUT (end) points and loop settings enabled. On the Home screen, the **⏮** icon lights up and the icon **■** lights up at the position corresponding to IN (start) and OUT (end) points under the playback indicator bar.

NOTE

- The I/O Too Short pop-up message will appear when the IN-OUT points are too close. Please reset by spacing at least one second in between.
- Press **ENTER/MARK** button again to clear the IN and OUT points.
- To stop loop playback, set the **PLAY FUNCTION** screen Quick menu **LOOP ON/OFF** to **OFF**. When off, **⏮** disappears from the Home screen. Set **LOOP ON/OFF** to **ON** again to enable loop playback between the set IN and OUT points.
- You cannot set the IN and OUT points in different files.
- The previous IN and OUT point settings are lost when you set the IN point in a different file.
- MP3 files with VBR (variable bit rate) format may affect the accuracy of the IN and OUT points settings.

Clearing IN and OUT points only

- When the **PLAY FUNCTION** screen is open, press **QUICK** to open the **QUICK** pop-up menu on the **PLAY FUNCTION** screen.
- Using the **wheel**, select (highlight) **IN CLEAR** or **OUT CLEAR** and press **ENTER/MARK** button.
The set IN and OUT points will be cleared.

Changing the playback speed (VSA)

The DR-44WL has a built-in VSA (Variable Speed Audition) function to change the playback speed without changing its pitch.

CAUTION

*The VSA function will not work when you select a file recorded at a sampling rate of 96 kHz or three or more channels (tracks) exist in MP3. However, the **SPEED** icon is displayed, and the setting of the playback speed can be changed.*

*To enable the settings of playback speed when a file recorded at a sampling frequency of 44.1 kHz or 48 kHz is loaded by using the **◀◀** button or **▶▶** button.*

- When the **PLAY FUNCTION** screen is open, press **QUICK** to open the **QUICK** pop-up menu on the **PLAY FUNCTION** screen.
- Using the **wheel**, select (highlight) **SPEED** and press **ENTER/MARK** button.
The screen for changing playback speed will be popped up.

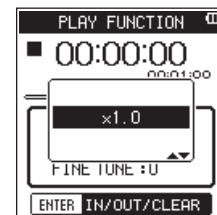

- Use the **wheel** to change the settings of playback speed.
Options: **x0.5** - **x2.0** (default value: per **x1.0**, **x0.1**)
- Press **ENTER/MARK** button to finalize the setting and return to open the **QUICK** pop-up menu on the **PLAY FUNCTION** screen.
- Press **■/HOME** button to the Home screen while maintaining the set playback speed enabled.
When the playback speed is larger than **1.0**, the **SPEED+** icon appears or when it is smaller than **1.0**, the **SPEED-** icon appears at the top of the Home screen.

7 – Playback

Key control playback

The DR-44WL can change the playback key (pitch) using its key control function.

In the key control function, the **KEY** item and **FINE TUNE** item are available. The **KEY** item can adjust in ± 6 half-tone, and the **FINE TUNE** item can move the key up or down in ± 50 cents.

CAUTION

*The key control playback cannot be used when a file recorded with a 96kHz sampling frequency or an MP3 with three or more channels (tracks) is selected. However, the **KEY** icon will still appear and the playback speed can still be changed.*

*This function will not affect this file, but it will become effective if you return to the Home screen and use the **◀◀** and **▶▶** buttons to select a file recorded with a 44.1kHz or 48kHz sampling frequency.*

1. When the **PLAY FUNCTION** screen is open, press **QUICK** to open the **QUICK** pop-up menu on the **PLAY FUNCTION** screen.
2. Using the **wheel**, select (highlight) **KEY** or **FINE TUNE** and press **ENTER/MARK** button.
The screen for changing keys will be popped up.

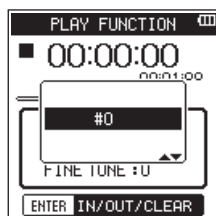

Pop-up display of the **KEY** item

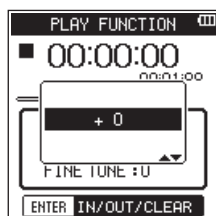

Pop-up display of the **FINE TUNE** item

3. Use the **wheel** to change the key settings.
Options
When **KEY** is selected : ± 6 - ± 6 (default value: ± 0 , per half-tone)
When **FINE TUNE** is selected : -50 - $+50$ (default value: $+0$, per cent)
4. Press **ENTER/MARK** button to finalize the setting and return to open the **QUICK** pop-up menu on the **PLAY FUNCTION** screen.
5. Press **■/HOME** button to the Home screen while maintaining the set playback speed enabled.
When the key control function is on, **KEY** appears at the top of the Home Screen.

Adding marks manually during playback

Press the **ENTER/MARK** button during playback to add a mark at that position.

The number of the added mark will be shown on a pull-up at the bottom of the display.

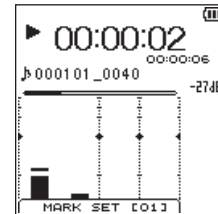

Clearing specified marks

Pause at the position of a mark. Then, press the **ENTER/MARK** button to clear that mark.



Setting the mark skip mode

Multiple types of marks can be added to files (**MARK**, **LEVEL**, **TIME** and **PEAK**). With this function, you can set what type of mark to use when moving between them.

1. Press the **MENU** button to open the **MENU** Screen.
2. Use the wheel to select **SYSTEM**, and press the **ENTER/MARK** or **▶▶** button.
The **SYSTEM** screen opens.
3. Use the wheel to select **MARK SKIP MODE**, and press the **ENTER/MARK** or **▶▶** button.

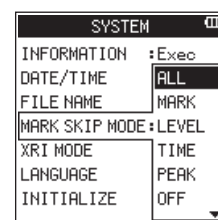

4. Use the wheel to set the mark skip mode.
Options
ALL (default): Move between all marks
MARK: Move between marks added manually
LEVEL: Move between marks added using the automatic mark function **LEVEL** setting
TIME: Move between marks added using the automatic mark function **TIME** setting
PEAK: Move between marks added when a **PEAK** indicator lit
OFF: Do not move between marks
5. Press the **ENTER/MARK** button to confirm the setting and reenables setting item selection.
6. When finished making the setting, press the **■/HOME** button to return to the Home Screen.

8 – QUICK Button Operation

QUICK button overview

The **QUICK** button allows you to do the following things.

- While the playback is stopped or paused on the Home screen, the QUICK pop-up menu for displaying current file information, setting playback control functions or mixing down will be displayed.

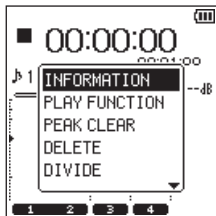

QUICK menu display while playback is stopped or paused when in 4CH mode

During playback, the QUICK pop-up menu for displaying current file information, setting playback control function, or clearing peak hold of the level meters will appear.

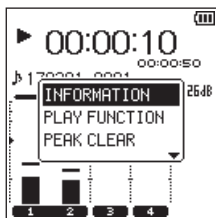

QUICK menu display during playback on the Home screen when in 4CH mode

In recording standby or recording mode, the QUICK pop-up menu for displaying current file information or clearing peak hold of the level meters will appear.

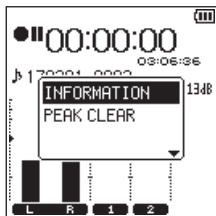

QUICK menu display during recording standby on the Home screen when in 4CH mode

- The QUICK pop-up menu for operating the selected file or folder appears on the **BROWSE** screen or **SONG** screen. (See “5 – Operating Files and Folders (4CH Mode Only)” on page 32.), (See “6 – Managing Songs (MTR Mode only)” on page 35.)

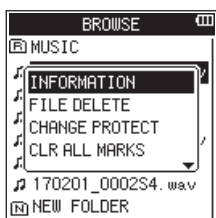

Quick menu display on the **BROWSE** screen when in 4CH mode

NOTE

When the **MENU** screen or the **REC SETTING** screen is open for various settings, the **QUICK** button is disabled.

Actions of the **QUICK** button for different screens and statuses are as follows.

Screen	State	Action
Home Screen	Stopped/paused	Displays file information (only in the 4CH mode) Playback Control Screen Clears peak hold of a level meter Deletes and splits a file (only in the 4CH mode) Mixing down Clear track function (only in MTR mode) Bounce function (only in MTR mode) Master track function (only in MTR mode)
	Playback	Displays file information (only in the 4CH mode) Playback Control Screen Clears peak hold of a level meter
	In recording standby	Displays file information (only in the 4CH mode) Clears peak hold of a level meter (only in the 4CH mode)
	In recording mode	Displays file information (only in the 4CH mode) Clears peak hold of a level meter
BROWSE screen/ SONG screen		Opens the QUICK pop-up menu for operating the selected file/folder (or song)
MENU screen/ MIXER screen, various settings screens		No operation

Quick menu operation

Press **QUICK** when the Homes screen is open to display the QUICK pop-up menu.

Use the wheel to select (highlight) the desired QUICK menu item, and press **ENTER/MARK** button to get the unit to work as follows:

NOTE

What appears on the QUICK menu is different in operation, depending on the state of the unit when QUICK is pressed.

- While playback is stopped or paused on the Home screen, the following functions can be selected.

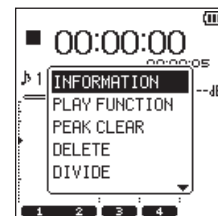

QUICK menu display while playback is stopped or paused when in 4CH mode

8 – QUICK Button Operation

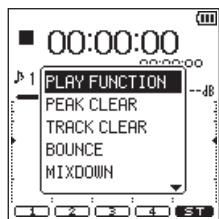

QUICK menu display while playback is stopped or paused when in MTR mode

INFORMATION (only in 4CH mode):

The current file or song information is displayed.

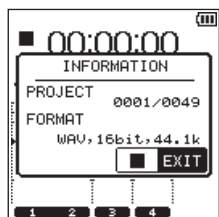

PLAY FUNCTION:

The PLAY FUNCTION screen is displayed. (See “Special Playback Control Functions” on page 38.)

PEAK CLEAR:

Clears the peak level displayed on the level meter.

DELETE (only in 4CH mode):

A pop-up message appears to confirm that you want to delete the current file. (See “Song Operation” on page 35.)

DIVIDE (only in 4CH mode):

The current file can be divided manually. (See “Dividing the selected file manually(DIVIDE)” on page 43.)

AUTO DIVIDE (only in 4CH mode):

The current file can be divided at a mark position set in advance. (See “Dividing the selected file automatically (AUTO DIVIDE)” on page 44.)

MIXDOWN:

This function combines four channels (two or more files) into two right and left channels (one file).

The effect level, volume balance, and right and left positions can be freely set on the MIXER screen. (See “Song Operation” on page 35.)

BOUNCE (MTR mode only):

This function can be used to bounce tracks in the current song. (See “Song Operation” on page 35.)

TRACK CLEAR (MTR mode only):

This function can be used to delete one track at a time in the current song. (See “Song Operation” on page 35.)

MASTER TRACK (MTR mode only):

The master track created can be loaded. (See “Loading master tracks (MTR mode only)” on page 46.)

- During playback on the Home screen, the following functions can be selected.

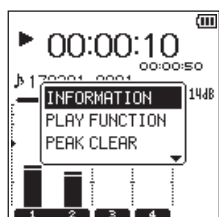

QUICK menu display during playback on the Home screen when in 4CH mode

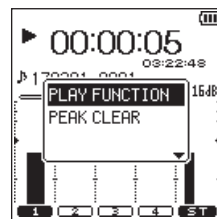

QUICK menu display during playback on the Home screen when in MTR mode

- During recording standby on the Home screen when in 4CH mode, the following functions can be selected.

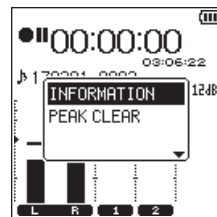

QUICK menu display during recording standby when in 4CH mode

- During recording on the Home screen, the following functions can be selected.

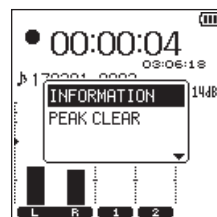

QUICK menu display during recording when in 4CH mode

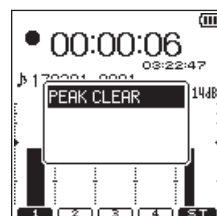

QUICK menu display during recording when in MTR mode

Closing the Quick menu

Press **QUICK** to close the Quick menu screen.

Deleting the selected file (Quick Delete, only when in 4CH mode)

The currently selected file can be deleted without using the BROWSE screen.

1. Press the **◀◀** button or the **▶▶** button to select the file you want to delete.
2. While the Home screen is open when stopped, press **QUICK** to open the QUICK pop-up menu.
3. Use the **wheel** to select **DELETE** and press the **ENTER/MARK** button.

The following pop-up confirmation message will appear.

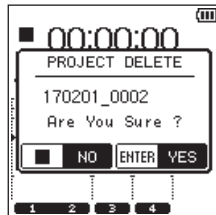

4. Press **ENTER/MARK** button to delete a file and return to the Home screen.
Press **■/HOME** button to cancel the delete operation and return to the Home screen.

NOTE

When you use the **DELETE** item from the Quick menu on the Home screen to delete, files for all the currently selected channels will be deleted.

When you use the **FILE DELETE** item from the Quick menu on the BROWSE screen to delete a file, deletion of individual files is possible.

Dividing the selected file (4CH mode only)

A recorded file can be divided into two manually or at a mark position.

CAUTION

- MP3 files cannot be divided.
- If the SD card has insufficient open space, division might not be possible.
- Division is not possible if the file name would become more than 200 characters long.
- Division is not possible if a file that already exists has the same name as the name that would be given to a new file created by division.

Dividing the selected file manually(DIVIDE)

A recorded file can be divided into two at a desired position.

1. Use the **◀◀** button, **▶▶** button, or the BROWSE screen to select the file you want to divide.
2. While the Home screen is open when stopped, press **QUICK** to open the QUICK pop-up menu.
3. Use the **wheel** to select **DIVIDE** and press the **ENTER/MARK** button.

The **DIVIDE** screen shown below will appear.



4. Use the **wheel** to determine the position where you want to divide the file and press **RECORD**.
The following confirmation message will pop-up:

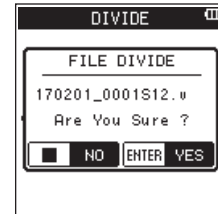

5. Press **ENTER/MARK** button to return to the Home screen after deleting the file.
Press **■/HOME** button to return to the **DIVIDE** screen without dividing the file.

NOTE

- When the **DIVIDE** screen is open, you can press the **▶/||** button and set the divide position while playing the track.
- When the **DIVIDE** screen is open, press the **▶/||** button to play, the **■/HOME** button to pause, the **◀◀** button to move to the beginning of a file or the **▶▶** button to move to the end of a file. Use the **wheel** to make fine adjustments of the division position.
- After a file is divided, files with **_a** or **_b** added to the end of file names will be created.

(Example of files recorded in 4CH mode)

File name before division

140826_0001S12.wav

140826_0001S34.wav

File name after division

140826_0001_aS12.wav (before the dividing point)

140826_0001_aS34.wav (before the dividing point)

140826_0001_bS12.wav (after the dividing point)

140826_0001_bS34.wav (after the dividing point)

- When multiple files are currently selected, multiple files are divided at a time.

CAUTION

- Division may not be available when there is not enough space on SD card.
- File name with more than 200 characters cannot be divided.
- File cannot be divided when there is a file name identical to that of the post-divided file.

TIPS

You can add cue marks during recording at the position you want to divide. (See "Create cue marks during recording" on page 27.)

8 – QUICK Button Operation

Dividing the selected file automatically (AUTO DIVIDE)

Use the AUTO DIVIDE function to automatically divide an already recorded file at positions where marks have been added.

NOTE

See “Create cue marks during recording” on page 27 for details about how to add marks.

1. Select a file to be divided at marks using the **◀◀** and **▶▶** buttons or the **BROWSE** screen.
2. While the Home Screen is open when stopped, press the **QUICK** button to open the Quick pop-up menu.
3. Use the **wheel** to select **AUTO DIVIDE** and press the **ENTER/MARK** button.

The following pop-up confirmation message will appear.

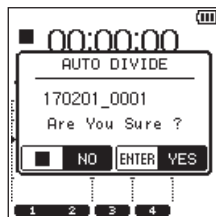

NOTE

If the file does not have any marks, a **Can't Divide No Mark** pop-up message will appear.

4. Press the **ENTER/MARK** button to divide the file and return to the Home screen.
Press the **■/HOME** button to cancel division and return to the Home screen.

NOTE

- After dividing a file, new files with **_01**, **_02** and **_03** added to the end of the original file name are created in order.
Example: 2 marks
File name before division
140826_0001.wav
File names after division
140826_0001_01.wav
140826_0001_02.wav
140826_0001_03.wav
- When used together with the automatic marking function, long recordings can automatically be divided into files with individual songs. (See “Add cue marks automatically during recording” on page 28.)

Deleting track input (MTR mode only)

1. Set the mode to **MTR** mode. (See “Selecting Operation Mode” on page 17.)
2. Load the song in which you want to delete tracks on the **SONG** screen. (See “Loading Songs” on page 35.)
3. While the Home Screen is open when stopped, press the **QUICK** button to open the Quick pop-up menu.
4. Use the wheel to select **TRACK CLEAR** and press the **ENTER/MARK** button.

This opens a pop-up where you can select the track to delete.

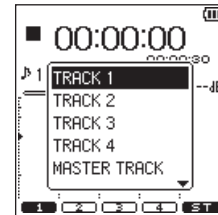

5. Use the **wheel** to select (highlight) tracks you want to clear and press **ENTER/MARK** button.

The following confirmation message will pop-up:

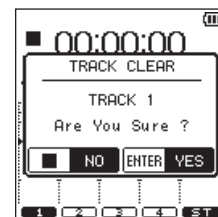

6. Press **ENTER/MARK** button to return to the Home screen after deleting the selected tracks.
Press the **■/HOME** button to return to the Home screen without clearing tracks.

8 – QUICK Button Operation

Track bounce (MTR mode only)

Use the track bounce (ping-pong recording) function to combine recorded tracks 1 - 4 into one track.

This function allows you to record on tracks 1 - 2 after mixing down tracks 1 - 4 (stereo bounce) or to record on track 1 by mono mixing tracks 1 - 4 (mono bounce).

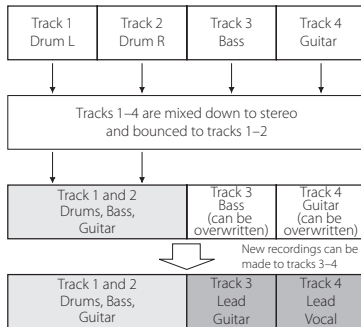

When recorded on the playback track itself, the original playback track is naturally cleared (the drum part in Track 1 - 2 is overwritten in the illustration above).

Bouncing tracks

1. Set the mode to **MTR** mode. (See "Selecting Operation Mode" on page 17.)
2. On the **SONG** screen, load songs in which you want to bounce tracks. (See "Loading Songs" on page 35.)
3. Press **TRACK/INPUT** for the track you want to use as bounce destination and make **TRACK/INPUT** blink. Among tracks selected as bounce destinations, the left channel of the mixed-down stereo source will overwrite the odd track and the right channel will overwrite the even track.
4. Press **MIXER** to open the MIXER screen and adjust **PAN** knob and the **LEVEL** knob for each track. (See "Setting the mixer" on page 47.)

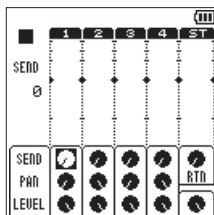

For mono bounce to odd-numbered track, set the **PAN** knob to L12. For mono bounce to even-numbered track, set the **PAN** knob to R12.

Adjust the overall level with the master level knob.

5. When the MIXER screen is open, press **MIXER** to return to the Home screen.
6. When playback is stopped or paused or when playing back, press **QUICK** to open the QUICK pop-up menu.

7. Using the **wheel**, select (highlight) **PLAY FUNCTION** and press **ENTER/MARK** button. The **PLAY FUNCTION** screen is displayed.



8. Set the **IN** and **OUT** points of bounce as the loop playback section. (See "Repeated Playback of Selection (Loop Playback)" on page 39.)

NOTE

When the IN/OUT points are not set, bounce from 00:00:00 to the final point of recording.

9. Press **■/HOME** button to return to the Home screen, and press **QUICK** to open the QUICK pop-up menu.
10. Using the **wheel**, select (highlight) **BOUNCE** and press the **ENTER/MARK** button. The following confirmation message will pop-up:

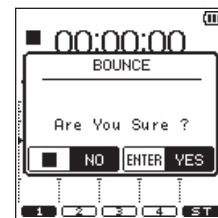

11. Press **ENTER/MARK** button to start track bounce and return to the Home screen after bouncing. Press the **■/HOME** button to return to the Home screen without track bouncing.

Confirming the results of bouncing

Lift the **LEVEL** knob for the track at the bounce destination and the master level knob (set the **LEVEL** knob for other tracks to minimum) to play back.

After bouncing tracks, you can record again (overdub) to the bounced tracks

TIPS

If it may be necessary to have the original track at a later date, back up the song data on your computer before bouncing (ping-pong recording). (See "11 – Connecting with a computer" on page 52.)

8 – QUICK Button Operation

Mixing down

This function combines multiple files into a single stereo file. Adjustments of the effect level (SEND), right and left positions (PAN), volume balance (LEVEL) can be freely set on the MIXER screen. (See "Setting the mixer" on page 47.)

1. Use the **◀◀/▶▶** button to select file you want to mix down on the BROWSE screen for 4CH operation mode or on the SONG screen for MTR operation mode. (See "Selecting Operation Mode" on page 17.)
2. While the Home Screen is open when stopped or paused, press the **QUICK** button to open the Quick pop-up menu.
3. Using the **wheel**, select (highlight) MIXDOWN and press the **ENTER/MARK** button.

The following confirmation message will pop-up:

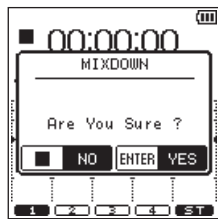

Pop-up display in 4CH mode

4. Press **ENTER/MARK** button to start mixing down return to the Home screen after mixing down.
Press the **■/HOME** button to return to the Home screen without mixing down files.
5. After mixdown completes, the Home screen reopens, and the mixdown file that was created is loaded. In this state, you can press the **▶/||** button to play the mixdown file.

NOTE

- When a mixdown file is created, it is named by adding an incremental number to the end of the name of the file used before mixdown.
- When files created in 4CH mode are mixed down, a file is created with "MIX" added to the end of the file name.

Loading master tracks (MTR mode only)

A file mixed down from files created in MTR mode can be loaded.

1. Set the operation mode to MTR. (See "Selecting Operation Mode" on page 17.)
2. Load the mixdown file on the SONG screen. (See "Loading Songs" on page 35.)
3. While the Home Screen is open when stopped or paused, press the **QUICK** button to open the Quick pop-up menu.
4. Use the wheel to select **MASTER TRACK** and press the **ENTER/MARK** button. This loads the master track and reopens the Home screen.

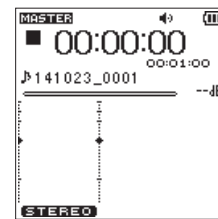

NOTE

The **MASTER** icon appears at the top of the Home screen when a master track is loaded.

If there is no master file, a **NO MASTER TRACK** pop-up message will appear.

5. Press the **▶/||** button to start playback of the master file.

NOTE

After loading the master track, select **MULTI TRACK** from the Quick menu and press the **ENTER/MARK** button to return to ordinary MTR mode.

The mixer functions that can be used for setting a built-in effect, right and left positions and volume balance for each channel are available.

Recording sound can be finely changed by setting these during mixing down or playback. (See “Mixing down” on page 46.)

Setting the mixer

1. When the Home screen is open, press **MIXER** to open the MIXER screen.

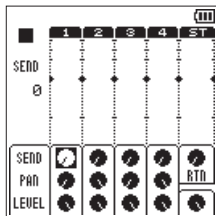

in 4CH mode

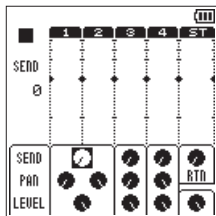

Stereo Link is set

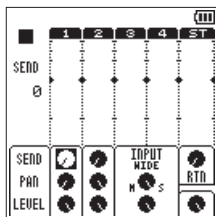

MS decoder is used

2. Use the **wheel** to select (highlight) an item you want to change).
3. Press **ENTER/MARK** button to pop up setting items and settings on the left.

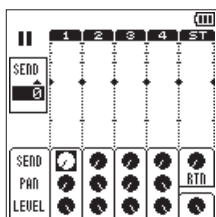

4. Use the **wheel** to change the setting.

Items	Options	Action
SEND	0 - 100	Adjusts the forwarding level of the selected reverb (See “Reverb function” on page 49.). (0: Minimum to 100: Maximum)
PAN	L12 - C - R12	Adjusts the balance between the right and left channels. (L12: Left - C: Center - R12: Right)
LEVEL:	0 - 100	Adjusts the volume balance between the right and left channels. (0: Minimum to 100: Maximum)
RTH	0 - 100	Adjust the total volume of the signals with reverb applied sent from the SEND buses of each channel (track).

5. Press the **ENTER/MARK** button to return to the original position where you can select the position to change the setting next time.

NOTE

- Operation is available in any mode when playing back, stopped, paused, or in recording standby or recording.
- While the MIXER screen is open, press the ► / || button to play back or press ■ / HOME button to pause the playback.

10 – Useful functions

Tuner function

A guitar and wind instruments can be tuned using a built-in chromatic tuner.

The tuner incorporated into this unit has chromatic tuner mode that allows tuning of musical instruments while looking at the tuning meter and oscillator mode that outputs reference sounds.

Chromatic tuner

1. Connect a guitar or bass to the **EXT MIC/LINE IN 1/L** or **2/R** jack.
Tune wind instruments using the built-in microphone.
2. Press the **MENU** button to open the **MENU** screen.
3. Using the **wheel**, select (highlight) **TOOLS** and press the **ENTER/MARK** or **▶▶** button.
TOOLS screen appears.
4. Use the wheel to select **TUNER** and press the **ENTER/MARK** or **▶▶** button.
Exec appears selected for the **TUNER** item.
5. Press the **ENTER/MARK** button to open the **TUNER** screen.

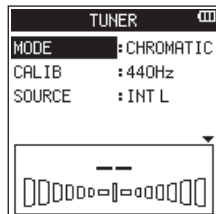

6. Use the **wheel** to select **MODE** and press the **ENTER/MARK** button.
7. Use the wheel to set the tuner mode to **CHROMATIC**.
Options: **CHROMATIC** (default value), **OSC**.
8. Press the **ENTER/MARK** button to confirm the setting and enable selection of other setting items.
9. Use the wheel to select **CALIB** and press the **ENTER/MARK** button.
10. Use the wheel to set the standard frequency of **A4**.
Range: **435Hz–445Hz** (default: **440Hz**)
11. Press the **ENTER/MARK** button to confirm the setting and enable selection of other setting items.
12. Use the wheel to select **SOURCE** and press the **ENTER/MARK** button.
13. Use the wheel to set the input for the sound to be tuned.

Options	Input destination
INT L (default)	Input from right front side of built-in stereo mic
INT R	Input from left back side of built-in stereo mic
EXT 1	Input from EXT MIC/LINE IN 1/L jack
EXT 2	Input from EXT MIC/LINE IN 2/R jack

14. Press the **ENTER/MARK** button to confirm the setting and enable selection of other setting items.

15. Perform tuning by playing a musical instrument.
The note that is closest to the sound you played is shown at the top of the tuning meter.
Tune the musical instrument so that the note you want to match is shown and the center of the tuning meter lights up.
A bar appears on the left or right of the center if the sound is lower or higher than the target pitch. The bar becomes longer as the sound shifts away from the target pitch.

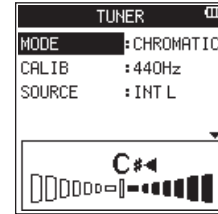

When the sound played matches the note exactly, **▶ ◀** on the right and left of the note lights up.

16. Once tuning has been completed, press **■/HOME** button to return to the Home screen.

Oscillator mode

1. Press the **MENU** button to open the **MENU** screen.
2. Using the **wheel**, select (highlight) **TOOLS** and press the **ENTER/MARK** or **▶▶** button.
TOOLS screen appears.
3. Use the **wheel** to select **TUNER** and press the **ENTER/MARK** or **▶▶** button.
Exec appears selected for the **TUNER** item.
4. Press the **ENTER/MARK** button to open the **TUNER** screen.
5. Use the **wheel** to select **MODE** and press the **ENTER/MARK** button.
6. Use the wheel to set the tuner mode to **OSC**.
Options: **CHROMATIC** (default value), **OSC**.
7. Press **ENTER/MARK** button to change the **TUNER** screen to the oscillator mode display.

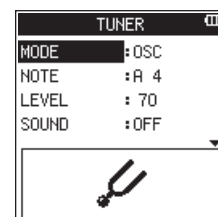

The following settings can be made in the oscillator mode display.

NOTE

Set the sound to output.

The setting range is from **C3** to **B5**. (default value: **A4**)

LEVEL

Set the output level.

The setting range is from **0** (minimum) to **100** (maximum). (default value: **70**)

8. Use the **wheel** and **ENTER/MARK** button to set **NOTE** and **LEVEL**.
9. Use the **wheel** and **ENTER/MARK** button to set **SOUND** to **ON** so that reference sound is output.

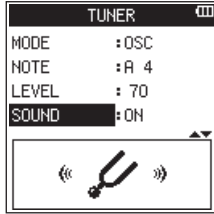

- Once tuning has been completed, set **SOUND** to **OFF** and press **■/HOME** button to return to the Home screen.

Metronome function

Metronome operates when the **METRONOME** screen is open.

- Press the **MENU** button to open the **MENU** screen.
- Using the **wheel**, select (highlight) **TOOLS** and press the **ENTER/MARK** or **▶▶** button. **TOOLS** screen appears.
- Use the wheel to select **METRONOME** and press the **ENTER/MARK** or **▶▶** button. **Exec** appears selected for the **METRONOME** item.
- Press the **ENTER/MARK** button to open the **METRONOME** screen.



Set the following items on the **METRONOME** screen.

TEMPO

Set speed between **20 - 250** (BPM).
(default value: **120**)

BEAT

Set beat between **1 - 9** (default value: **4**)
This will accent the first beat.

SOUND

You can set the metronome sound to **CLICK**, **STICK** or **BELL**. (default value: **CLICK**)

LEVEL

Set the metronome volume between **0** and **100**. (default value: **50**)

- Use the wheel to select the item to set and press the **ENTER/MARK** button. This shows the parameters for the item to be set.
- Use the wheel to select the value. Press the **ENTER/MARK** button to confirm it and enable selection of other setting items.
- Repeat steps 5 and 6 as necessary.
- Press the **▶/||** button to start the metronome. Press the **▶/||** button to stop the playing metronome.

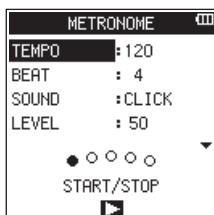

- Once the setting has been completed, press the **■/HOME** button to return to the Home screen.

Reverb function

A reverb is incorporated into this unit.

When recording or practicing, the input signal can be reverbed or the playback signal can be reverbed during playback.

When reverb function is **ON**, the **REVERB** icon will appear at the top of the home screen.

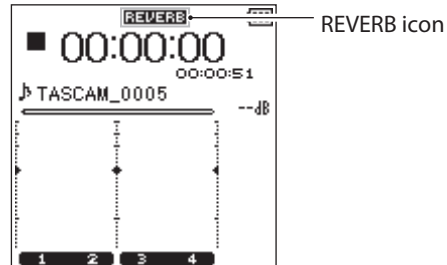

Setting the reverb function

- Press the **MENU** button to open the **MENU** screen.
- Using the **wheel**, select (highlight) **REVERB** and press the **ENTER/MARK** or **▶▶** button. The **REVERB** screen is displayed.

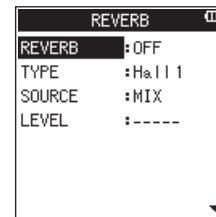

The **REVERB** screen has four setting items.

REVERB:

Set the reverb on/off status (default value: **OFF**).

TYPE:

See the reverb type from the pre-set items. See (See "How to download and install the exclusive application (DR CONTROL)" on page 53.) for more details on reverb types.

SOURCE:

You can select input/output source to be reverbed from the following: (default value: **MIX**)

SOURCE (options)	Detail
MIX (default value)	Enabled for SEND : Reverb can be added to the output sound. The recorded sound is not affected.
INT MIC	Enabled for input: Reverb can be added to the sound input from the built-in mic. Sound can be recorded with reverb added.
EXT IN	Enabled for input: Reverb can be added to the sound input from external mics and devices. Sound can be recorded with reverb added.

When **MIX** is sent, the forwarding level (**SEND**) to the effect of each signal can be set on the **MIXER** screen. (See "Setting the mixer" on page 47.)

10 – Useful functions

LEVEL:

Use this to change the input/output level of the sound set with SOURCE to which reverb is applied. Settings can be selected from 0 - 100. (default value: 70)

- Use the **wheel** to select (highlight) the desired item and press the **ENTER/MARK** or **▶▶** button to set options/values.
- Use the **wheel** to set the desired option/value.
- Press the **ENTER/MARK** button to confirm the setting and enable selection of other setting items.
- Once the setting has been completed, press the **■/HOME** button.

CAUTION

When sampling frequency is set to 96 kHz or the WAV file with 96 kHz sampling frequency is played back, the reverb function does not work. In this case, reverb can be set.

Reverb type pre-set list

Pre-set name	Effect
HALL 1 (default value)	A bright effect, like a spacious hall
HALL 2	A warm effect, like a spacious hall
ROOM	Small room effect
STUDIO	Studio effect
PLATE 1	Bright plate reverb
PLATE 2	Warm plate reverb

Setting the XRI information recording function (4CH mode only)

When recording in the BWF file format, the unit can also record XRI information (eXtended Recording Information), which includes the input volume and other recording settings.

- Press the **MENU** button to open the MENU Screen.
- Use the wheel to select **SYSTEM**, and press the **ENTER/MARK** or **▶▶** button.
The **SYSTEM** screen opens.
- Use the wheel to select **XRI MODE**, and press the **ENTER/MARK** or **▶▶** button.

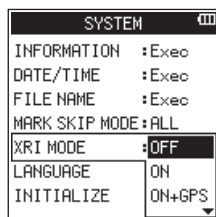

- Use the wheel to set the XRI information recording mode.
Options:
 - OFF: XRI information not recorded
 - ON (default): Record only XRI information
 - ON+GPS: Record XRI and GPS information
- Press the **ENTER/MARK** button to confirm the setting and reenabling setting item selection.
- When finished making the setting, press the **■/HOME** button to return to the Home Screen.

CAUTION

GPS information is acquired from the dedicated app (DR CONTROL). This information cannot be acquired when using the unit without the app. Information acquired is as follows.

LATITUDE: *Latitude data*

LONGITUDE: *Longitude data*

Viewing XRI information (4CH mode only)

You can check XRI and GPS information recorded in a BWF-compliant WAV file on the XRI screen.

Follow these procedures to open the XRI screen.

- Use the **◀◀** and **▶▶** buttons or the **BROWSE** screen to select the file with information that you want to view.
- While the Home Screen is open when stopped, press the **QUICK** button to show the quick menu pop-up.
- Use the wheel to select **XRI**.

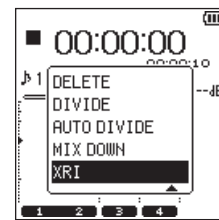

- Press the **ENTER/MARK** button to open the XRI screen that shows the following XRI information.
If no information has been recorded, **No Data** is shown

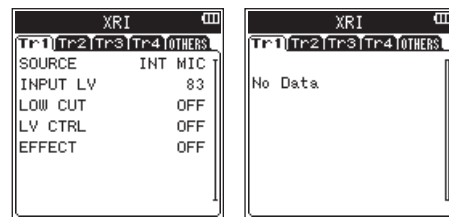

- Use the **◀◀** and **▶▶** buttons to switch between tabs to view XRI information for each track. Select the **OTHERS** tab to view the following information about the unit

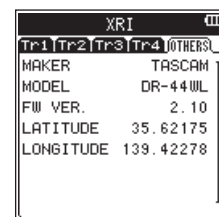

- Press the **■/HOME** button to return to the Home Screen.

Deleting XRI information (4CH mode only)

You can delete XRI and GPS information.

- When the XRI screen is open, press the **QUICK** button to open the quick menu pop-up.

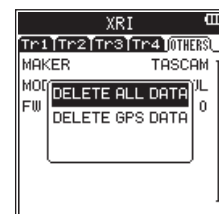

- Use the wheel to select which information to delete.
Options

DELETE ALL DATA: Delete XRI and GPS information.

DELETE GPS DATA: Delete only GPS information.

3. Press the **ENTER/MARK** button.

The following confirmation pop-up message appears.

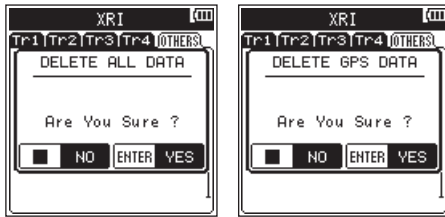

4. Press the **ENTER/MARK** button to clear the selected type of information and return to the Home Screen.

Press the **■/HOME** button to cancel deleting the data and return to the Home Screen.

11 – Connecting with a computer

By connecting this unit with a computer using the USB cable, you can transfer audio files on the SD card in the unit to a computer, as well as transfer audio files on the computer to the SD card in the unit.

This unit can handle audio files of the following formats.

WAV : 44.1k/48k/96kHz, 16/24 bit

BWF : 44.1k/48k/96kHz, 16/24 bit

MP3 : 44.1k/48kHz, 32k/64k/96k/128k/192k/256k/320kbps

Computer

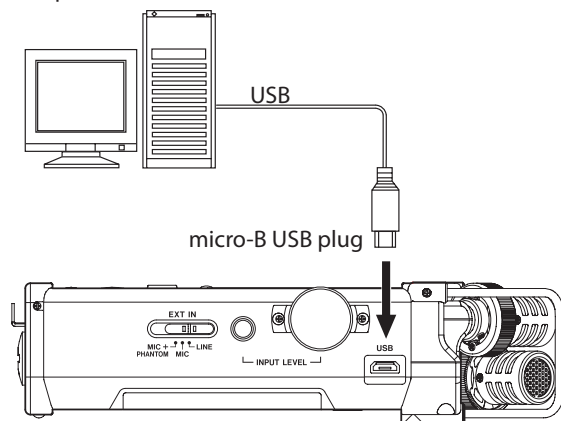

NOTE

- Instead of connecting the DR-44WL a computer via USB, you can remove the SD card from the unit and insert directly (or with a card adapter) to the computer and make the same operation.
- Both WAV and BWF files will have the ".wav" extension.

CAUTION

- The DR-44WL will not operate when STORAGE is selected (highlighted) under USB connection.
- Please make a direct connection with the computer without using a hub.

When you connect a USB cable while the unit power is on, or turn on the power after making a connection, the USB SELECT screen will pop up, prompting the user to select either to operate the unit with USB bus power or make a USB connection with the computer.

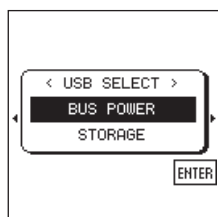

Use the **wheel** to select (highlight) STORAGE, and press **ENTER/MARK** button to connect the unit with the computer. The message of USB connected appears.

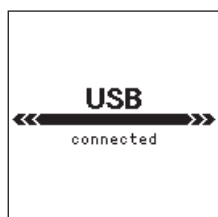

Make sure that an SD card has been inserted properly into the DR-44WL.

NOTE

Power is supplied from the USB port if the USB cable is connected to the unit that contains batteries (USB bus power prioritized).

If an SD card is not properly inserted before making the USB connection, a Can't Save Data pop-up message will appear. When you open "computer", DR-44WL appears on the computer screen as an external drive with a volume label of "DR-44WL".

Transferring files to a computer

1. Click the "DR-44WL" drive on the computer screen to show the "MTR", "MUSIC" and "UTILITY" folders.
2. Open the "MTR" or "MUSIC" folder and drag and drop the files that you want to transfer to the destinations of your choice on the computer.

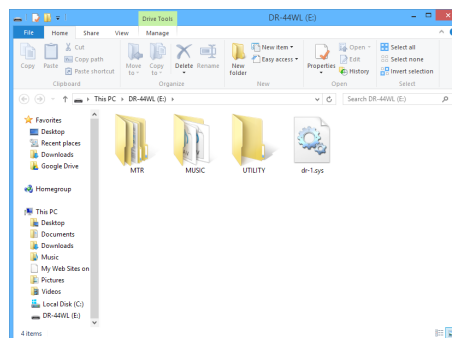

Transferring files from a computer

1. Click the "DR-44WL" drive on the computer screen to show the "MTR", "MUSIC" and "UTILITY" folders.
2. Drag and drop files on the computer that you want to transfer to the unit to the "MTR" or "MUSIC" folder.

TIPS

- You can manage the "MTR" or "MUSIC" folder from the computer.
- You can create a sub-folder in the "MUSIC" folder. The DR-44WL can create up to two layers. The DR-44WL cannot recognize sub-folders and files located at the third layer level or below.
- If you name sub-folders and music tracks, these names will appear on the Home screen or BROWSE screen of this unit.

NOTE

- The "UTILITY" folder is used when updating the unit system, for example.
- Do not change names, delete or otherwise alter individual files inside the "MTR" folder.

Disconnecting the unit from a computer

When disconnecting the DR-44WL from the computer, make sure to follow the correct steps and remove the USB cable. The power turns off after the unit completes its shutdown (standby) process.

See the computer's operation manual for instructions on how to unmount an external volume.

Connect the unit and smart phone via Wi-Fi

CAUTION

The DR-44WL designs are in conformance with the laws and regulations of the countries and regions in which this unit is sold, and labeled as required.

The DR-44WL is approved in the following countries and regions:

United States, Canada, Europe (EU member states),
Australia, New Zealand, Japan

The use of wireless functions in a country other than those listed above could result in a violation of that country's wireless transmission laws.

Our company will bear no responsibility for use in countries other than those listed above.

TIPS

The battery will drain faster during Wi-Fi use.

Running out of batteries during data transfer will terminate the process and may result in transfer failure.

We recommend using either the AC adapter or USB bus power during Wi-Fi use.

The DR-44WL is designed for remote control with the use of an exclusive application (DR CONTROL), free of charge.

Transport control such as playback and stop, as well as input level adjustment and file transfer can be made via Wi-Fi.

How to download and install the exclusive application (DR CONTROL)

1. Connect your smart phone to the Internet.
2. Search the exclusive application (DR CONTROL) and download from either Google Play (Android smart phone) or App Store (iOS device) for installation.

Selecting the Wi-Fi mode

You can choose from two connection modes according to the use conditions.

■ TO DEVICE mode

This unit operates as an access point, and computers, smartphones and other external devices can connect to it by Wi-Fi.



■ VIA ROUTER mode

This unit can connect to computers, smartphones and other external devices by Wi-Fi through an existing Wi-Fi router. This allows more flexibility. This also enables simultaneous connection to the Internet, allowing easier file sharing and location information checking, for example.

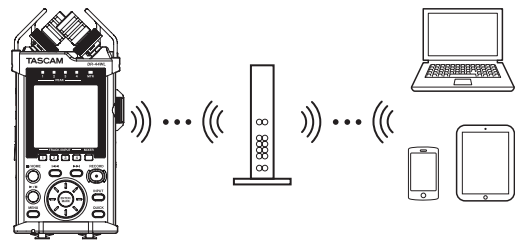

Connecting the unit directly to external devices (smartphones, tablets and computers) by Wi-Fi (TO DEVICE mode)

The DR-44WL can make a Wi-Fi/peer-to-peer connection with a smart phone via Wi-Fi, without the use of a router or other external devices. No Wi-Fi network environment is required. It can make direct connection with your smart phone or tablet.

NOTE

During Wi-Fi/peer-to-peer connection, the smart phone or tablet cannot connect to an external Wi-Fi network.

■ Setting the Wi-Fi mode to TO DEVICE

1. Press the **MENU** button to open the MENU screen.
2. Using the **wheel**, select (highlight) **TOOLS** and press the **ENTER/MARK** or **▶▶** button.
TOOLS screen appears.
3. Use the **wheel** to select **Wi-Fi** and press the **ENTER/MARK** button.
Exec appears selected for the **Wi-Fi** item.

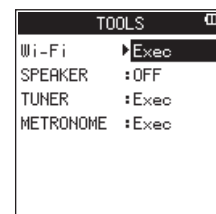

4. Press the **ENTER/MARK** button to open the **Wi-Fi** screen.
5. Use the **wheel** to select **MODE** and press the **ENTER/MARK** button.
6. Use the **wheel** to set the Wi-Fi mode to **TO DEVICE**, and press the **ENTER/MARK** button to confirm it.
Options: **TO DEVICE** (default value), **VIA ROUTER**

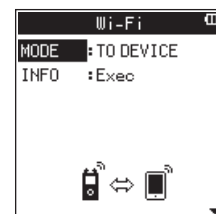

■ Connecting the DR-44WL to a smart phone or tablet via Wi-Fi for the first time

1. Press the **Wi-Fi** button of the DR-44WL; the **Wi-Fi** indicator will start to flash.
A **CONNECT TO THE NEW DEVICE ?** pop-up message appears on the display to determine whether or not the connection is new.
2. You will be making a connection to a new smartphone, so press the **ENTER/MARK** button.

12 – Using Wi-Fi

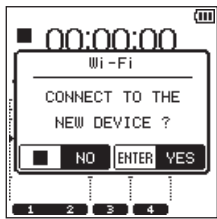

- SSID and PASSWORD appear on the display.



NOTE

The SSID is the name of the wireless LAN access point (wireless LAN device).

- Select "setting" → "Wi-Fi" on the device.

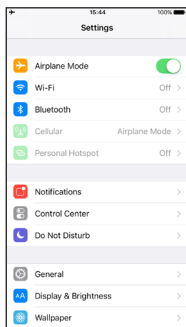

iOS device example

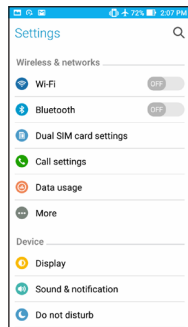

Android device example

- When Wi-Fi is enabled on for your device, it will display the SSID list of Wi-Fi equipment. Select the SSID displayed on the DR-44WL.

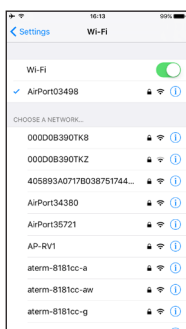

iOS device example

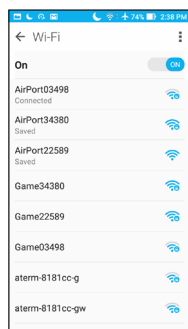

Android device example

- A password input screen appears on the device. Enter the password shown on the display of the unit.
- Wi-Fi connection is established between the DR-44WL and your smart phone, and the **Wi-Fi** indicator of the unit will light.

NOTE

The above description on operating the device are for reference only. Please refer to your smart phone's operation manual for more details.

■ Connecting the DR-44WL to a smart phone or tablet via Wi-Fi (from second time onward)

When you establish a connection between the DR-44WL and your smart phone for the first time and need to connect them again, you only need to select the SSID from the second time onward.

- Press the **Wi-Fi** button of the DR-44WL; the **Wi-Fi** indicator will start to flash.
A **CONNECT TO THE NEW DEVICE ?** pop-up message appears on the display to determine whether or not the connection is new.
- Your smart phone already made a peer-to-peer connection; simply press the **■/HOME** button.

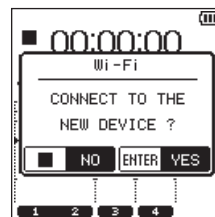

- Pop-up message on the display disappears and the DR-44WL switches to a standby mode to connect to your smart phone.
- In your device, select "setting" → "Wi-Fi".
- When Wi-Fi is enabled on for your device, it will display the SSID list of Wi-Fi equipment. Select the SSID displayed on the DR-44WL.
- Wi-Fi connection is established between the DR-44WL and your smart phone, and the **Wi-Fi** indicator of the unit will light.

NOTE

The above description on operating the device are for reference only. Please refer to your smart phone's operation manual for more details.

■ Checking Wi-Fi connection information

- When the **Wi-Fi** screen is open, use the **whell** to select the **INFO** item, and press the **ENTER/MARK** or **▶▶** button. **Exec** appears selected for the **INFO** item.



- Press the **ENTER/MARK** button to open the **INFORMATION** screen.

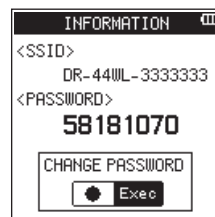

SSID and PASSWORD information appears. The SSID is used to identify this unit on the Wi-Fi network. The PASSWORD is necessary when connecting to this unit by Wi-Fi.

NOTE

Press the **RECORD** button to change the password.

Connecting the unit to external devices (smartphones, tablets and computers) by Wi-Fi (VIA ROUTER mode)

■ Setting the Wi-Fi mode to VIA ROUTER

1. Press the **MENU** button to open the MENU screen.
2. Using the **wheel**, select (highlight) **TOOLS** and press the **ENTER/MARK** or **▶▶** button. **TOOLS** screen appears.
3. Use the **wheel** to select **Wi-Fi** and press the **ENTER/MARK** button. **Exec** appears selected for the **Wi-Fi** item.

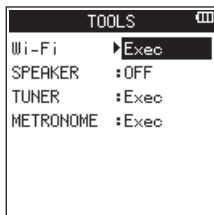

4. Press the **ENTER/MARK** button to open the **Wi-Fi** screen.
5. Use the **wheel** to select **MODE** and press the **ENTER/MARK** button.
6. Use the **wheel** to set the Wi-Fi mode to **VIA ROUTER**, and press the **ENTER/MARK** button to confirm it. Options: **TO DEVICE** (default value), **VIA ROUTER**

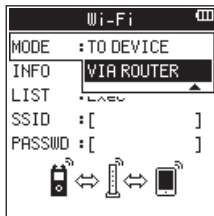

■ Connecting the unit to an external router

1. When the **Wi-Fi** screen is open, use the **wheel** to select the **LIST** item, and press the **ENTER/MARK** or **▶▶** button. **Exec** appears selected for the **LIST** item.

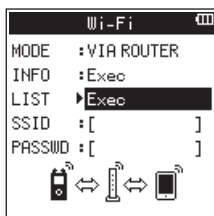

2. Press the **ENTER/MARK** button to open the **SSID LIST** screen.



3. From the list shown on the **SSID LIST** screen, use the **wheel** to select the router you want to connect, and press the **ENTER/MARK** button to set it.
4. The selected SSID will be shown for the **SSID** item.

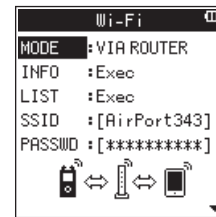

NOTE

The **SSID** can also be input directly using the **Wi-Fi** screen **SSID** item.

To do this, at the **SSID** item, use the **◀◀** and **▶▶** buttons to move the cursor, and use the **wheel** to set the characters. Press the **ENTER/MARK** button to confirm the **SSID**.

5. When the **Wi-Fi** screen is open, use the **wheel** to select the **PASSWD** item, and press the **ENTER/MARK** or **▶▶** button.
6. At the **PASSWD** item, use the **◀◀** and **▶▶** buttons to move the cursor, and use the **wheel** to set the router password (encryption key). Press the **ENTER/MARK** button to confirm the router password (encryption key).

- The following message appears when connection with the router has succeeded. The **Wi-Fi** indicator on the unit lights.



- The following message appears if connection with the router fails. Input the correct password.

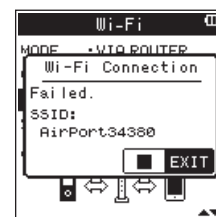

NOTE

- In many cases, the router password (encryption key) is on a label on the router itself or in its operation manual, for example.
- After connection with a router has succeeded once, reconnection will be possible by just pressing the **Wi-Fi** button on this unit. Passwords for the two most recent connections are stored in this unit.

■ Connecting a smartphone or other device to an external router

1. Select "**setting**" → "**Wi-Fi**" on the device.

12 – Using Wi-Fi

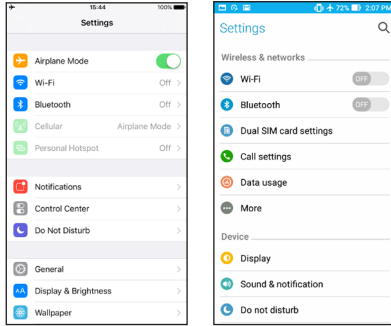

iOS device example Android device example

- When the device Wi-Fi is turned on, a Wi-Fi device SSID list will appear. Select the SSID of the external router to use.

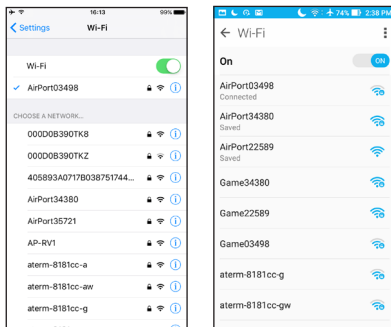

iOS device example Android device example

- Input the password for that external router. A Wi-Fi connection between the smartphone and the external router will be established.

■ Checking the Wi-Fi connection information

- When the **Wi-Fi** screen is open, use the **wheel** to select the **INFO** item, and press the **ENTER/MARK** or **▶▶** button. **Exec** appears selected for the **INFO** item.

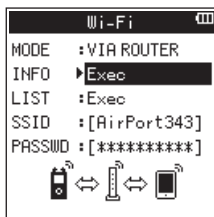

- Press the **ENTER/MARK** button to open the **INFORMATION** screen.

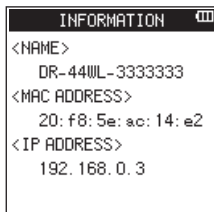

NAME, MAC ADDRESS, and IP ADDRESS information is shown. NAME shows the name to select when using DR CONTROL to operate this unit. MAC ADDRESS shows the MAC address assigned to the unit. IP ADDRESS is the number on the Wi-Fi network assigned by the router.

Launching DR CONTROL

- After completing the Wi-Fi connection, launch the DR CONTROL app (installed beforehand) on the smartphone or other device.

NOTE

Always use the latest version of DR CONTROL.

- A screen like the following will appear when the app launches, and remote operation of the device will be enabled.

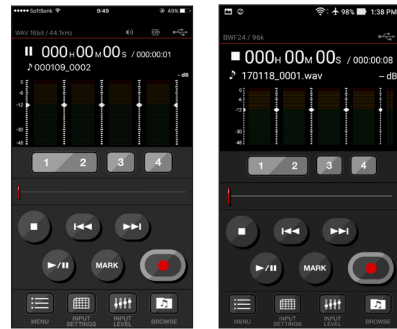

iOS device example Android device example

■ When multiple DR-44WL/DR-22WL units are connected to the same router in VIA ROUTER mode

- A little while after the app launches, “**DR List**” will appear. Select the DR-44WL that you want to control.

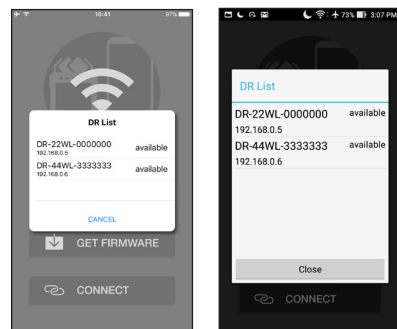

iOS device example Android device example

- If “**DR is not found**” appears, touch the “**OK**” button, then touch the “**CONNECT**” button to reacquire the list.

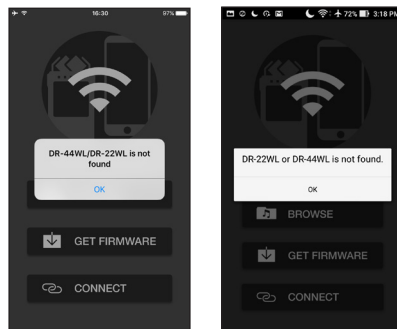

iOS device example Android device example

Please refer to your smart phone’s operation manual for more details.

Detailed descriptions, on the “DR CONTROL” application, including the “DR CONTROL reference manual”, can be downloaded from the TEAC Global Site (<http://teac-global.com>).

Connecting this unit to a computer by Wi-Fi

Transferring files from this unit to a computer is possible using the free TASCAM DR FILE TRANSFER software designed for this purpose. You can transfer recorded files by Wi-Fi.

Downloading and installing the TASCAM DR FILE TRANSFER software

1. Connect the computer to the Internet.
2. Download TASCAM DR FILE TRANSFER from the TEAC Global Site (<http://teac-global.com/>) and install it.

Connecting the unit directly to a computer by Wi-Fi (TO DEVICE mode)

1. Press the **MENU** button to open the **MENU** screen.
2. Using the **wheel**, select (highlight) **TOOLS** and press the **ENTER/MARK** or **▶▶** button. **TOOLS** screen appears.
3. Use the **wheel** to select **Wi-Fi** and press the **ENTER/MARK** button. **Exec** appears selected for the **Wi-Fi** item.

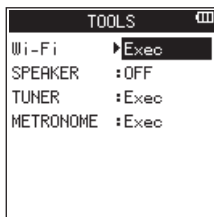

4. Press the **ENTER/MARK** button to open the **Wi-Fi** screen.
5. Use the **wheel** to select **MODE** and press the **ENTER/MARK** button.
6. Use the **wheel** to set the Wi-Fi mode to **TO DEVICE**, and press the **ENTER/MARK** button to confirm it.
Options: **TO DEVICE** (default value), **VIA ROUTER**



7. Press the **Wi-Fi** button of the unit to make the **Wi-Fi** indicator blink. A **CONNECT TO THE NEW DEVICE ?** pop-up message appears on the display to determine whether or not the connection is new.
8. Since it is a new connection, press the **ENTER/MARK** button.

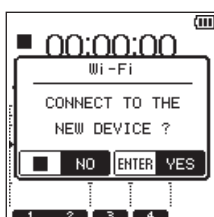

9. **SSID** and **PASSWORD** appear on the display.

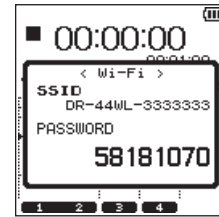

NOTE

The SSID is the name of the wireless LAN access point (wireless LAN device).

10. Click the wireless connection icon in the computer taskbar/menu bar (Windows/Mac) to open a list of wireless networks.

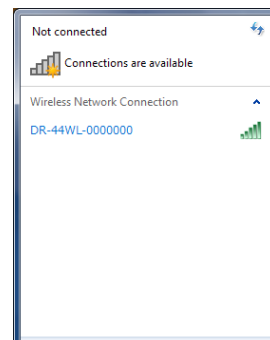

Windows

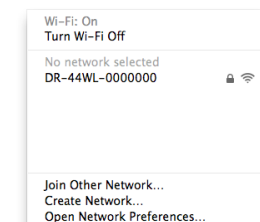

Mac

11. Select the SSID shown on the unit's display.
12. When the security key input screen appears on the computer, input the password shown on the display of the unit.



Windows

When the password input screen appears on the computer, input the password shown on the display of the unit.

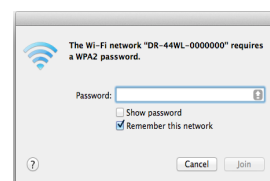

Mac

13. The **Wi-Fi** indicator on the unit lights when the Wi-Fi connection is established between the unit and the computer.

Connecting this unit to a computer by Wi-Fi after the first time

After the unit and the computer have been connected once, they can be connected again just by selecting the SS ID.

1. Press the **Wi-Fi** button of the unit to make the **Wi-Fi** indicator blink.
A **CONNECT TO THE NEW DEVICE ?** pop-up message appears on the display to determine whether or not the connection is new.
2. Since the unit has been connected to the computer previously, press the **■/HOME** button.

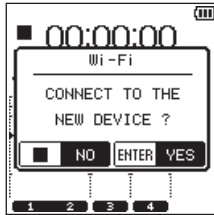

3. When the pop-up message disappears from the display, the unit is waiting to connect to the computer.
4. Click the wireless connection icon in the computer taskbar/menu bar (Windows/Mac) to open a list of wireless networks.
5. Select the SSID shown on the unit's display.
6. The Wi-Fi indicator on the unit lights when the Wi-Fi connection is established between the unit and a computer.

TIPS

For instructions about connecting a DR-44WL in VIA ROUTER mode to a computer using a Wi-Fi connection through a router and other details about the software, download the TASCAM DR FILE TRANSFER Owners Manual from the TEAC Global Site (<http://teac-global.com>).

13 – Settings and Information

View information (INFORMATION)

Use the **INFORMATION** screen to view various types of information about this unit.

Follow the below steps to display the **INFORMATION** screen:

1. Press the **MENU** button to open the **MENU** screen.
2. Using the **wheel**, select (highlight) **SYSTEM** and press the **ENTER/MARK** or **▶▶** button.
SYSTEM screen appears.
3. Use the **wheel** to select **INFORMATION** and press the **ENTER/MARK** or **▶▶** button.
EXEC appears selected for the **INFORMATION** item.
4. Press the **ENTER/MARK** button to open the **INFORMATION** screen.

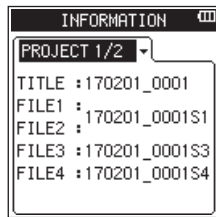

The **INFORMATION** screen has the following pages.

5. Use the **wheel** to change the page.
The following information appears on each page.
PROJECT 1/2 page (4CH mode only):
Displays the names of the audio files in the currently loaded project
PROJECT 2/2 page (4CH mode only):
Displays various types of information about the currently loaded project
CARD page:
Displays information on the inserted SD card.
SYSTEM page:
Displays information on the system settings and firmware version of the unit.

Project information page 1 (PROJECT 1/2) (4CH mode only)

The **PROJECT 1/2** page shows the names of the audio files in the currently loaded project.

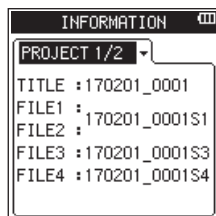

■ TITLE/FILE1-4

Shows the file name.

If an MP3 file has ID3 tag title information that information appears.

Project information page 2 (PROJECT 2/2) (4CH mode only)

The **PROJECT 2/2** page shows various types of information about the currently loaded project.

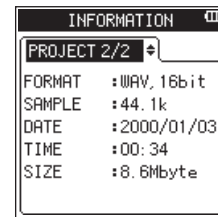

■ FORMAT

Shows the audio file type.

For WAV and BWF files, bit length also appear.

For MP3 files, the bit rate (kbps), CBR (constant bit rate) or VBR (variable bit rate) type also appear.

■ SAMPLE

Sampling frequency (Hz)

■ DATE

Date of file creation

■ TIME

Time of file creation

■ SIZE

File size

Card information page (CARD)

CARD page display information on the inserted SD card.

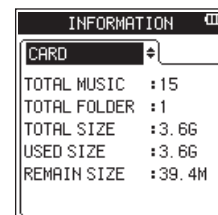

■ TOTAL MUSIC

Displays the number of playable files in the music folder.

■ TOTAL FOLDER

Displays the total number of folders in the music folder.

■ TOTAL SIZE

Shows the total SD card capacity.

■ USED SIZE

Displays the amount of used capacity on the SD card.

■ REMAIN SIZE

Displays available free space of the SD card.

System information page (SYSTEM)

SYSTEM page display information on the firmware version of the unit.

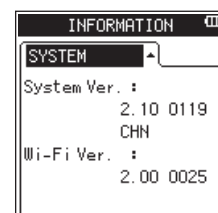

13 – Settings and Information

■ System Ver.

Displays the system's firmware version.

■ Wi-Fi Ver.

Displays the Wi-Fi firmware version.

Configuration (SYSTEM)

The **SYSTEM** screen allows you to initialize the setting of the unit and format the SD card.

Follow the below steps to display the **SYSTEM** screen:

1. Press the **MENU** button to open the **MENU** screen.
2. Using the **wheel**, select (highlight) **SYSTEM** and press the **ENTER/MARK** or **▶▶** button. **SYSTEM** screen appears.

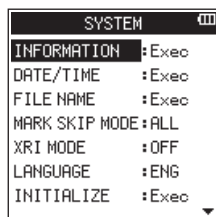

Use **◀◀** button and **▶▶** button, **ENTER/MARK** button and **wheel** to make settings for different items.

The following settings for each item can be made in the **SYSTEM** screen.

Setting the file name type

This unit can set name types of the recording files.

1. Use the **wheel** to select **FILE NAME** and press the **ENTER/MARK** or **▶▶** button. **Exec** appears selected for the **FILE NAME** item.
2. Press the **ENTER/MARK** button to open the **FILE NAME** screen.

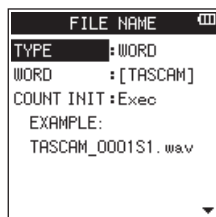

3. Use **◀◀** button and **▶▶** button, **ENTER/MARK** button and **wheel** to make settings for different items.

The following settings for each item can be made in this screen.

■ File name type

In the **TYPE** item, select either the **DATE** or **WORD** options.

Options:

DATE (default value): dates will be included in file name.

Example: 140101_0001S12.wav

WORD: the six characters set in **WORD** will be included in file name.

Example: TASCAM_0001S12.wav

NOTE

The internal clock of the unit is used to set dates. (See "Setting the date/time" on page 14.)

■ Setting characters (WORD)

In the **WORD** item, use either the **◀◀** button or the **▶▶** button to move the cursor, and turn the **wheel** to set characters.

In addition to alphabets and numbers, the following characters can be used: ! # \$ % & ' () + , - . ; = @ [] ^ _ ` { } ~

■ Initializing the numbers (COUNT INIT)

To execute, press **ENTER/MARK** button in the **COUNT INIT** item. All newly created files will be assigned with numbers set in the **WORD** item, starting from the **0001** count.

Setting the language

Use the **LANGUAGE** item to set the language shown on the display.

1. Use the **wheel** to select the **LANGUAGE** item and press the **ENTER/MARK** button.

Options

Eng. :	use English
日本語:	use Japanese
Fran. :	use French
Españ:	use Spanish
Deu. :	use German
Ital. :	use Italian
Pyc. :	use Russian

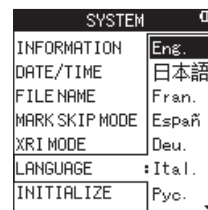

2. Turn the **wheel** to move the cursor and select the language.
3. Press the **ENTER/MARK** button to open a pop-up confirmation window.



4. Press the **ENTER/MARK** button to confirm the language selection. To cancel language selection, press the **■/HOME** button.

Restoring the DR-44WL to factory settings

Use the **INITIALIZE** item to execute initialization; this will restore the unit to factory settings.

1. Use the **wheel** to select **INITIALIZE** and press the **ENTER/MARK** or **▶▶** button.

Exec appears selected for the **INITIALIZE** item.

2. Press the **ENTER/MARK** button to open a pop-up confirmation window.



- Press the **ENTER/MARK** button to initialize the unit.
Press **■/HOME** button to cancel initialization.

Completely format a SD card

Use the **MEDIA FORMAT** item to format the SD card. Formatting erases all music files on the card and automatically creates new "MTR", "MUSIC" and "UTILITY" folders as well as a "dr-1.sys" file.

- Use the wheel to select **MEDIA FORMAT** and press the **ENTER/MARK** or **▶▶** button.
- Select the formatting method.

Option	Details
QUICK (default value)	Quickly format the card.
ERASE	Erase and format the card.

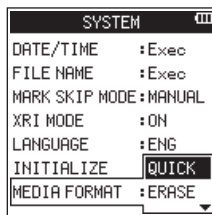

NOTE

- Using the **ERASE** formatting option might restore an SD card that has decreased writing performance due to repeated use.
 - ERASE** formatting checks for memory errors as it formats, so it takes more time compared to **QUICK** formatting.
- Press the **ENTER/MARK** button to open a pop-up confirmation window.

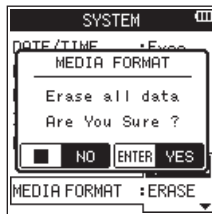

- Press the **ENTER/MARK** button to execute the formatting.
Press the **■/HOME** button to cancel the formatting.

CAUTION

When formatting the SD card, make sure that the unit is connected to either the dedicated AC adapter (GPE053B) provided with the unit or the USB bus power from a computer, or operating on fully-charged batteries. Formatting may not complete successfully if the battery runs out.

Power and display settings (POWER/DISPLAY)

Use the **POWER/DISPLAY** screen to set the power and display of the unit.

Follow the below steps to display the **POWER/DISPLAY** screen:

- Press the **MENU** button to open the **MENU** screen.
- Using the **wheel**, select (highlight) **POWER/DISPLAY** and press the **ENTER/MARK** or **▶▶** button.
The **POWER/DISPLAY** screen will appear.

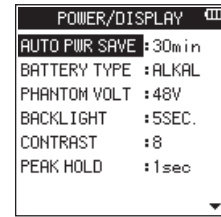

- Use **◀◀** button and **▶▶** button, **ENTER/MARK** button and **wheel** to make settings for different items. The following settings for each item can be made in the **POWER/DISPLAY** screen.

Auto power save function setting

Use the **AUTO PWR SAVE** item to set the time for automatic turn-off (standby mode), counting from the last operation.

Options: OFF (no automatic turn-off), 3min, 5min, 10min, 30min (default value)

Battery type settings

Use the **BATTERY TYPE** item to set the battery type.

This setting is used to display the remaining battery power and to calculate the minimum capacity for normal operation.

Options: ALKAL (alkaline batteries, default value), Ni-MH (nickel-metal hydride batteries)

Set the voltage value of the phantom power supply

Use the **PHANTOM VOLT** item to set the voltage value of the phantom power supply to connect an external microphone that requires phantom power.

Options: +24 V, +48 V (default value)

NOTE

Battery power will be consumed faster when set to +48 V than when set to +24 V.

Backlight setting

Use the **BACKLIGHT** item to set the time for automatic turn-off of back-light in battery operation, counting from the last operation.

Options: OFF (turned off), 5SEC. (default value), 10SEC., 15SEC., 30SEC., ALWAYS (always turned on)

Adjusting the display contrast

Use the **CONTRAST** item to adjust the display contrast.

Options: 1 - 20 (default value: 8)

Set the peak hold

Use the **PEAK HOLD** item to set the peak display of the level meter.

Options: OFF, 1sec (default value), HOLD

14 – Messages

The following is a list of pop-up messages.

DR-44WL displays pop-up messages according to situations. Refer to this list when you want to know the meaning of each message and a method of dealing with a problem.

Message	Details and solutions
Battery Empty	The batteries are empty. Replace the batteries.
Can't Divide	The selected division point is not appropriate for DIVIDE action. (Beginning of a file, end of a file)
Card Error	The SD card cannot be recognized properly. Replace the card.
Card Full	The SD card has no remaining capacity. Erase unnecessary files or transfer them to a computer.
Current File MP3	MP3 files cannot be divided.
Dup File Name	The name of the DIVIDE file to be created is identical to the name of the file that already exists in the same folder. The DIVIDE function adds “_a” or “_b” to the end of the file name. Before using the DIVIDE function, connect the DR-44WL to a computer and edit the file name.
File Full	The total number of folders and files exceeded the limit (5000). Delete unnecessary folders and files or move them to a computer.
File Name ERR	The DIVIDE function would cause the file name to exceed 200 characters. The DIVIDE function adds “_a” or “_b” to the end of the file name. Before choosing the DIVIDE function, connect the unit to a computer and edit the file name to less than 198 characters.
File Not Found	The file cannot be found or damaged. Check the target file.
File Not Found Make Sys File	System files required to operate the DR-44WL is missing. When this message appears, press the ENTER/MARK button to automatically create a system file.
File Protected	The file is read only and cannot be erased.
Format Error Format CARD	The SD card is not formatted properly or the card may be broken. This message also appears when a computer under USB connection formatted the card, or when an unformatted card is inserted to the unit. Always use the DR-44WL to format cards to be used with it. Replace the SD card with another or press the ENTER/MARK button while this message is being shown to format the card. Formatting will erase all the data on the SD card.
Invalid Card Change Card	The SD card may be abnormal. Replace the SD card.
Invalid SysFile Make Sys File	The system file required to operate this unit is invalid. When this message is being displayed, press the ENTER/MARK button to create a new system file.
I/O Too Short	The IN (start) and OUT (end) points are too close. Re-set by spacing at least one second in between.

Message	Details and solutions
Low battery, Wi-Fi OFF	The battery charge is low, so Wi-Fi cannot be used. Replace the batteries with new ones.
Max File Size	The file is larger than the designated size, or the recording time has exceeded 24 hours when the total number of folders and files was already at the limit (5000).
MBR Error Init CARD	The SD card is not formatted properly or the card may be broken. Replace the SD card with another or press the ENTER/MARK button while this message is being shown to format the card. Formatting will erase all the data on the SD card.
No Card	A SD card is not set. Insert a recordable SD card.
Non-Supported	The file type is not supported. Please see “11 - Connecting with a Computer” for file formats that this unit can use.
Write Timeout	Writing to the SD card was not in time. Back up files to a computer and format the card.
Can't Save Data	Restart the unit when this error message appears. If the power cannot be turned off, remove the batteries, disconnect the dedicated AC adapter (GPE053B) provided with the unit, or disconnect the USB cable when in bus power supply. If the error message continues to appear frequently, please contact the store where you purchased this unit or a TASCAM customer support service.
Device Error	
File Error	
Not Continued	
Player Error	
Writing Failed	
Sys Rom Err	
System Err XX (XX is a number.)	

15 – Troubleshooting

If you are having trouble with the operation of this unit, please try the following before seeking repair. If these measures do not solve the problem, please contact the store where you purchased this unit or TASCAM customer support service.

■ The power does not turn on.

- Are batteries low?
- Are batteries inserted correctly with the ⊕, ⊖ terminals aligned correctly?
- Confirm that the power plug of the dedicated AC adapter (GPE053B) provided with the unit and a USB connector are securely inserted.
- Is the USB cable connecting the computer for USB bus power securely connected?
- Is the USB hub in use with computer connection for USB bus power?

■ The DR-44WL turn the power off automatically

- Is the automatic power saving function on? (See “Auto power save function setting” on page 61.)
- The DR-44WL is in compliance with the European Standby Power Regulations (ErP), and therefore, the automatic power saving function will work whether the unit is being powered by an AC adapter or batteries. Select OFF if you do not want to use the auto power saving function (the factory default setting is 30min).

■ The unit does not function.

- Is the **HOLD/⏻/|** switch set at **HOLD**?
- Is the unit connected to a computer via USB cable (USB Connected)?

■ The SD card is not recognized.

- Confirm that the SD card is inserted completely.

■ The DR-44WL don't play back

- If the file is WAV format, check whether its sampling rate is compatible with the unit.
- If the file is MP3 format, check whether the bit rate is compatible with the unit.

■ The built-in speaker does not emit sound

- Is a headphone connected to the unit?
- Is the **SPEAKER** item set as OFF?
- Is the unit in recording or recording standby mode?

■ The monitor system does not emit sound

- Is the monitoring system securely connected?
- Is the monitoring system volume at minimum level?
- Is the output level setting of the unit at minimum level?

■ The DR-44WL is not recording

- Check the connection again.
- Check the input settings again.
- Is the input level low?
- Confirm that the SD card is not full.
- Check whether the number of files has reached the maximum level.

■ The input level is too low

- Is the input level setting too low?
- Is the output level of the connected device too low?

■ The sound I want to record is distorted

- Is the input level setting too high?
- Is reverb setting ON?

■ Playback sound is not natural

- Is the playback speed changed?
- Check the setting status of the playback equalizer.
- Confirm that the level alignment function is not enabled.
- Is reverb setting ON?

■ The file cannot be deleted

- Is the file a copy of a read-only file set by a computer?

■ The computer does not display the unit's files

- Is the DR-44WL connect to a computer via USB port?
- Is USB hub in use?
- Is the unit in recording or recording standby mode?

■ The DR-44WL cannot make a Wi-Fi connection or communication is interrupted

- Check that the Wi-Fi device is turned ON and/or the Wi-Fi function is ON.
- Is the distance to the Wi-Fi device too far?
Is there any obstacles in between, for example a wall?
When a Wi-Fi device is located at the rear side of the DR-44WL, the unit itself maybe the cause of interruption.
Try changing the positions of the Wi-Fi device and the unit.
- Turn OFF and restart the DR-44WL.
- Delete the registration of “DR-44WL” in the Wi-Fi device and follow the steps in “Connecting the unit to a Wi-Fi device”.
- Relaunch the DR CONTROL application.
- When using VIA ROUTER mode:
 - Disconnect other devices that are connected to the Wi-Fi router.
 - Move the Wi-Fi router to a different location.

■ The wrong language was set accidentally.

Slide the **HOLD/⏻/|** switch to turn the power off. Then, slide the **HOLD/⏻/|** switch while pressing and holding the **MENU** button to turn the unit on again.

The language selection menu will appear, and you will be able to select the language.

16 – Specifications

Rating

■ Recording media

SD card (64 MB - 2 GB)
SDHC card (4 GB - 32 GB)
SDXC card (48 GB - 128 GB)

■ Recording/playback formats

BWF: 44.1k/48k/96kHz, 16/24 bit
WAV: 44.1k/48k/96kHz, 16/24 bit
MP3: 44.1k/48kHz, 32k/64k/96k/128k/192k/256k/320kbps

■ Number of channels

4 channels

- 4CH mode
 - Mono: Up to 4 files
 - Stereo: Up to 2 files
 - Stereo (1 file) + mono (up to 2 files)
- MTR mode
 - Mono: Up to 4 files

Input/output ratings

Analog audio input and output ratings

■ EXT MIC/LINE IN jack (supporting phantom power supply)

Connector: Combo type
XLR-3-31
(1: GND, 2: HOT, 3: COLD)
6.3 mm (1/4") TRS standard jack
(Tip: HOT, Ring: COLD, Sleeve: GND)

When the EXT IN switch is at MIC, or at MIC+PHANTOM

Input impedance: 2.2 k Ω or more
Reference input level: -17.3 dBu \pm 2 dB
Maximum input level: -1.3 dBu \pm 2 dB

When the EXT IN switch is at LINE

Input impedance: 2.2 k Ω or more
Reference input level: +4 dBu
Maximum input level: +20 dBu

■ Ω /LINE OUT jack

Connector: 1/8" (3.5 mm) stereo mini jack
Output impedance: 12 Ω
Reference output level: -14 dBV (with 10 k Ω load)
Maximum output level: +2 dBV (with 10 k Ω load)
Maximum output: 20 mW + 20 mW (with headphones connected, with 32 Ω load)

■ Built-in speaker

0.3 W (mono)

Control input/output ratings

■ USB port

Connector: Micro-B type
Format: USB 2.0 HIGH SPEED mass storage class

Audio performance

■ Frequency response

20-20 kHz +1/-3 dB
(EXT IN to LINE OUT, 44.1 kHz sampling frequency, JEITA)
20-22 kHz +1/-3 dB
(EXT IN to LINE OUT, 48 kHz sampling frequency, JEITA)
20-40 kHz +1/-3 dB
(EXT IN to LINE OUT, 96 kHz sampling frequency, JEITA)

■ Distortion

0.05% or less
(EXT IN to LINE OUT, 44.1/48/96 kHz sampling frequency, JEITA)

■ S/N ratio

92 dB or higher
(EXT IN to LINE OUT, 44.1/48/96 kHz sampling frequency, JEITA)
Note) Based on JEITA: JEITA CP-2150

Wi-Fi

■ Wireless standard

Based on IEEE 802.11b/g/n (2.4 GHz only)

■ Wireless communication mode

TO DEVICE mode
Simple access point (Limited AP)
VIA ROUTER mode
Infrastructure (Station)

■ Security

WPA2-PSK (WPS2.0 compatible)

16 – Specifications

General

■ Power supply

- 4 AA batteries (alkaline or NiMH)
- USB bus power from a computer
- Dedicated AC adapter (GPE053B provided with the unit)
- Dedicated AC adapter (TASCAM PS-P520E; sold separately)

■ Power consumption

- 2.5W (maximum)

■ Battery operation time (continuous operation)

- Alkaline batteries (EVOLTA)

Format	Operation time	Note
Recording in 2ch WAV, 96 kHz, 24 bit	About 13 hours	Input from the built-in microphone
Recording in 2ch WAV, 44.1 kHz, 16 bit	About 16 hours	Input from the built-in microphone
Recording in 2ch MP3, 44.1 kHz, 128 kbps	About 14 hours	Input from the built-in microphone
Recording in 4ch WAV, 96 kHz, 24 bit	About 13 hours	Input from the built-in microphone + line input
Recording in 4ch WAV, 44.1 kHz, 16 bit	About 13.5 hours	Input from the built-in microphone + line input
Recording in 4ch MP3, 44.1 kHz, 128 kbps	About 13.5 hours	Input from the built-in microphone + line input
Recording in 4ch WAV, 44.1 kHz, 16 bit	About 5 hours	Built-in stereo mic and line inputs with phantom power on
Recording in 4ch WAV, 44.1 kHz, 16 bit	About 5.5 hours	Built-in stereo mic and line inputs with Wi-Fi on
Recording in 2ch WAV, 44.1 kHz, 16 bit	About 15.5 hours	When using a headphone
Recording in 2ch MP3, 44.1 kHz, 128 kbps	About 16 hours	When using a headphone

Recording: JEITA recording time Playback: JEITA music playback time

- Using NiMH batteries (eneloop)

Format	Operation time	Note
Recording in 2ch WAV, 96 kHz, 24 bit	About 10.5 hours	Input from the built-in microphone
Recording in 2ch WAV, 44.1 kHz, 16 bit	About 12.5 hours	Input from the built-in microphone
Recording in 2ch MP3, 44.1 kHz, 128 kbps	About 10 hours	Input from the built-in microphone
Recording in 4ch WAV, 96 kHz, 24 bit	About 10.5 hours	Input from the built-in microphone + line input
Recording in 4ch WAV, 44.1 kHz, 16 bit	About 11.5 hours	Input from the built-in microphone + line input

Format	Operation time	Note
Recording in 4ch MP3, 44.1 kHz, 128 kbps	About 11 hours	Input from the built-in microphone + line input
Recording in 4ch WAV, 44.1 kHz, 16 bit	About 5 hours	Built-in stereo mic and line inputs with phantom power on
Recording in 4ch WAV, 44.1 kHz, 16 bit	About 5.5 hours	Built-in stereo mic and line inputs with Wi-Fi on
Recording in 2ch WAV, 44.1 kHz, 16 bit	About 12.5 hours	When using a headphone
Recording in 2ch MP3, 44.1 kHz, 128 kbps	About 12 hours	When using a headphone

Recording: JEITA recording time Playback: JEITA music playback time

NOTE

The battery operation times (during continuous operation) could vary depending on the media being used.

■ Dimensions

79 × 162.2 × 42.5 mm (W x H x D)

■ Weight

346 g/251 g (including batteries/not including batteries)

■ Operating temperature

0°C–40°C

Dimensional drawings

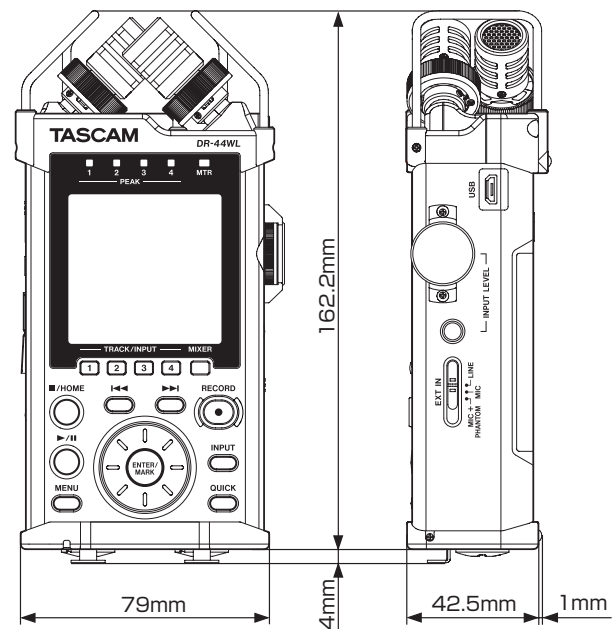

- Illustrations in this manual may be different from the actual product.
- To improve the product, specifications and external appearance may change without prior notice.

TASCAM

TEAC CORPORATION

Phone: +81-42-356-9143

1-47 Ochiai, Tama-shi, Tokyo 206-8530 Japan

<https://tascam.jp/jp/>

TEAC AMERICA, INC.

Phone: +1-323-726-0303

10410 Pioneer Blvd. Suite #1 and #4, Santa Fe Springs, California 90670, U.S.A.

<https://tascam.com/us/>

TEAC UK Ltd.

Phone: +44-1923-797205

Meridien House, 69-71 Clarendon Road, Watford, Herts, WD17 1DS, United Kingdom

<https://tascam.eu/>

TEAC EUROPE GmbH

Phone: +49-611-71580

Bahnstrasse 12, 65205 Wiesbaden-Erbenheim, Germany

<https://tascam.de/>

TEAC SALES & TRADING(SHENZHEN) CO., LTD

Phone: +86-755-88311561~2

Room 817, Block A, Hailrun Complex, 6021 Shennan Blvd., Futian District, Shenzhen 518040, China

<http://tascam.cn/>